

PMC-2HSP/PMC-2HSN Series

2-axis High Speed Interpolation/Normal Motion Controller

■ Features

- Independent 2-axis controlling with high operating speed of max. 4Mpps
- Linear/Circular interpolation control (PMC-2HSP)
- Realizing a wide variety of operation up to 200 steps using 17 control commands combination (13 commands except arc/linear interpolation command for PMC-2HSN series)
- Various control interface available (USB, RS232C, RS485, Parallel I/F)
- Controlling up to 32 axes (16-unit) via RS485 serial communication (Modbus RTU)
- 4 operation modes: Jog, Continuous, Index, Program mode
- Symmetrical/asymmetrical trapezoid, S-shaped de/acceleration driving function

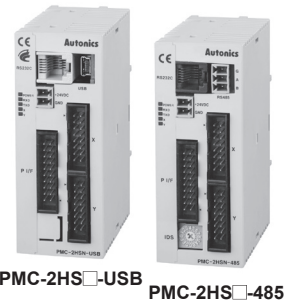

⚠ Please read "Safety Considerations" in the instruction manual before using.



(except for PMC-2HS□-485)

■ User Manual

Please refer to user manual for detailed instructions and specifications.

Visit our website (www.autonics.com) to download user manual and software [atMotion].

User manual describes installing software, setting parameter and program, operation mode, and multi-axis operation, etc. to operate motion controller.

■ Software (atMotion)

atMotion is the windows software designed to operate motion control for motion device.

- Compatible with Microsoft Windows 98, NT, XP (32-bit, 64-bit), Vista (32-bit, 64-bit), 7 (32-bit, 64-bit), 8 (32-bit, 64-bit) and 10 (32-bit, 64-bit)
- Supports 1200, 2400, 4800, 9600, 19200, 38400, 57600, 115200 bps communication speeds
- Available to use on all OS supported COM ports (COM1 to COM256)
- Multilingual support (Korean, English)
- Provides the calculator for convenience (calculates PPS, center of interpolation, end coordinates)

< Computer specification for using software >

Item	Minimum requirements
System	IBM PC compatible computer with Intel Pentium III or above
Operations	Microsoft Windows 98/NT/XP/Vista/7/8/10
Memory	256MB+
Hard disk	1GB+ of available hard disk space
VGA	Resolution: 1024×768 or higher
Others	RS-232 serial port (9-pin), USB port

< atMotion screen >

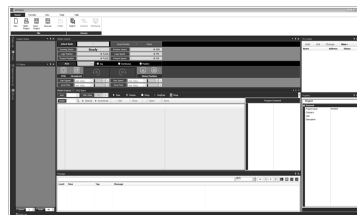

■ Standard Operation Method

There are three methods to operate the motion controller.

- Operation by PC
Connect a PC and the controller with communication cable and run dedicated program (atMotion).
- Operation by Parallel I/F
Connect a sequence controller or switch to Parallel I/F.
- Operation by serial communication (dedicated communication protocol)
Using serial communication protocol, operate according to program writing by user.

■ Ordering Information

PMC	–	2HSP	–	USB	
				Communication type	USB / RS232C
					485 / RS485 / RS232C
		Axis/Type			2HSP 2-axis high speed interpolation
					2HSN 2-axis high speed normal
Item					PMC Programmable Motion Controller

2-axis High Speed Interpolation/Normal Motion Controller

■ Specifications

Model	PMC-2HSP-USB	PMC-2HSP-485	PMC-2HSN-USB	PMC-2HSN-485
Control axes	2-axis			
Motor for control	Pulse train input stepper motor or servo motor			
Power supply	24VDC=			
Allowable voltage range	90 to 110% of rated voltage			
Power consumption	Max. 6W			
In-Position range	-8,388,608 to 8,388,607 (selectable absolute/relative value, available pulse-scaling function)			
Drive speed	1pps to 4Mpps (1 to 8,000pps×magnification 1 to 500)			
Pulse output method	1-Pulse/2-Pulse output method (line driver output)			
Operation mode	Jog / Continuous / Index / Program mode			
Number of index steps	64 indexes per axis			
Program function	Steps	200-step		
	Control command	ABS, INC, HOM, LID ^{※1} , CID ^{※1} , FID ^{※1} , RID ^{※1} , TIM, JMP, REP, RPE, ICJ, IRD, OPC, OPT, NOP, END		
	Start	Available power On program auto start setting		
	Home search	Available power On home search setting		
Home search mode	High speed near home search (Step 1) → Low speed near home search (Step 2) → Encoder Z phase search (Step 3) → Offset movement (Step 4)			
I/O	<ul style="list-style-type: none"> Parallel I/F (CN3): 13 inputs, 4 outputs X-axis (CN4) / Y-axis (CN5): 8 inputs, 6 outputs (general-purpose I/O, two of each) 			
Environment	Ambient temperature	0 to 45°C, storage: -15 to 70°C		
	Ambient humidity	20 to 90%RH, storage: 20 to 90%RH		
Accessory	<ul style="list-style-type: none"> [Common] Power connector, I/O connector: 3 (P/F, X-axis, Y-axis), RS232C communication cable (1.5m): 1 [USB type] USB communication cable 1m: 1 •[RS485 type] RS485 connector: 1 			
Approval	CE	CE	CE	CE
Weight ^{※2}	Approx. 344g (approx. 101.5g)	Approx. 308.7g (approx. 101.6g)	Approx. 344g (approx. 101.5g)	Approx. 308.7g (approx. 101.6g)

※1: These commands are only for PMC-2HSP series.

※2: The weight includes packaging. The weight in parenthesis is for unit only.

※Environment resistance is rated at no freezing of condensation.

■ Program Commands

Command type	Code	Description
Drive commands	ABS	Move absolute position
	INC	Move relative position
	HOM	Home search
	LID ^{※1}	2-axis linear interpolation
	CID ^{※1}	2-axis CW circular interpolation
	FID ^{※1}	2-axis CW arc interpolation
	RID ^{※1}	2-axis CCW arc interpolation
I/O commands	ICJ	Jump input condition
	IRD	Stand-by external input
	OPC	ON/OFF output port
	OPT	ON pulse from output port
Program control commands	JMP	Jump
	REP	Start repetition
	RPE	End repetition
	END	End program
Others	TIM	Timer
	NOP	No operation

※1: These commands are only for PMC-2HSP series.

SENSORS

CONTROLLERS

MOTION DEVICES

SOFTWARE

(Y)
Closed Loop
Stepper System

(Z)
Stepper Motors

(AA)
Drivers

(AB)
Motion
Controllers

PMC-2HSP/PMC-2HSN Series

■ Connections

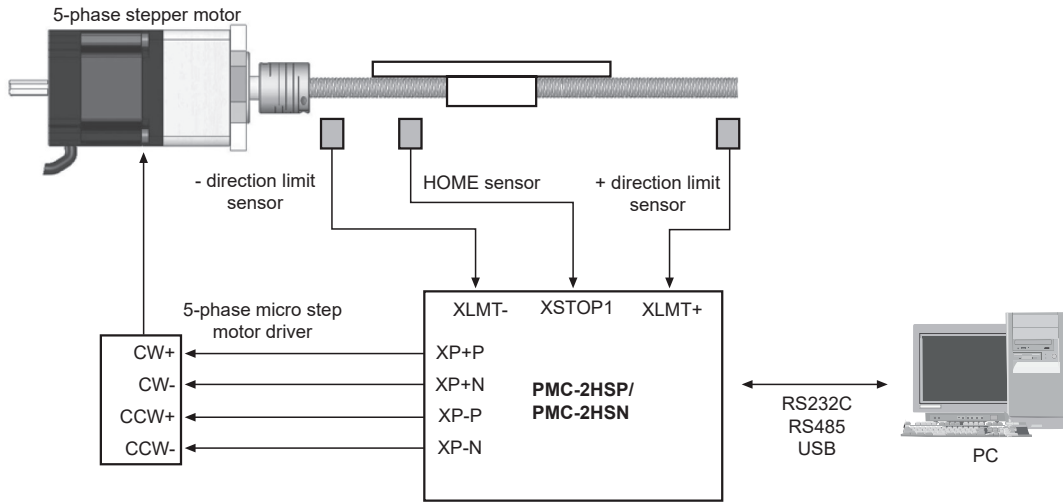

< Basic configuration of the motion controller (configuration only for X-axis) >

■ Dimensions

(unit: mm)

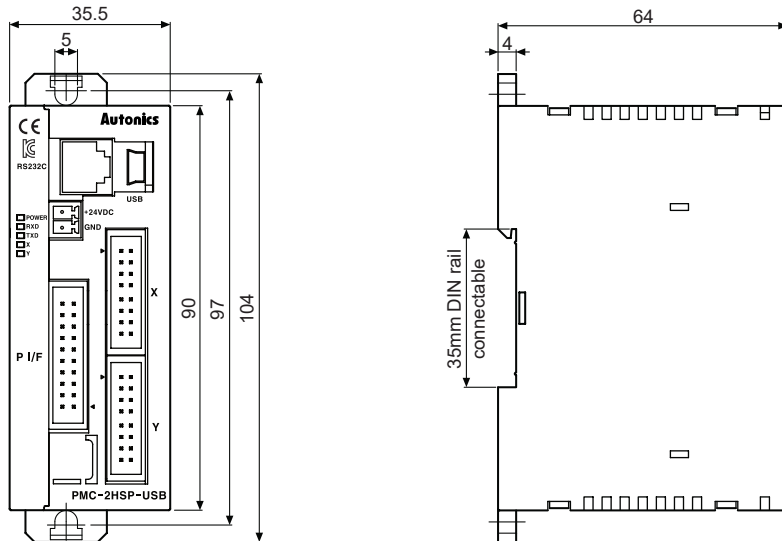

2-axis High Speed Interpolation/Normal Motion Controller

Unit Descriptions

PMC-2HS-USB

PMC-2HS-485

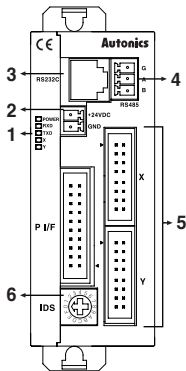
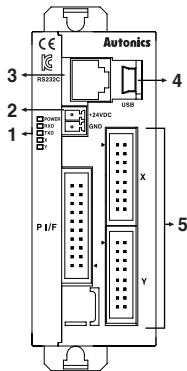

- 1. Power / Status indicator**
Used to indicate power, communication status of the controller, and operation status of each axis.
- 2. Power connector terminal**
Used to connect power for controller
- 3. RS232C connector terminal**
Used to connect RS232 serial (RJ12-DSUB9) connection cable
- 4. USB/RS485 connector terminal**
Used to connect USB and RS485 connection cable
- 5. External I/O connector terminal**
Used to operate various drives through input and output of Parallel I/F, X, Y
- 6. ID select switch**
Used to set unique ID for each node in case of RS485 communication

External I/O Terminal Connection

PMC-2HS-USB

PMC-2HS-485

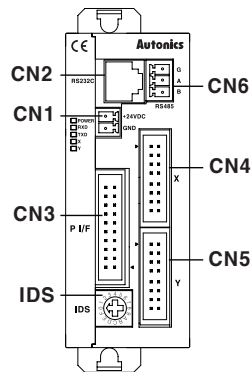
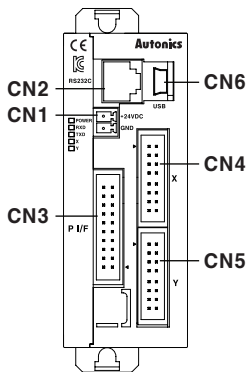

Connector

Connector no.	Description
CN1	Power connector
CN2	RS232C connector
CN3	Parallel I/F connector
CN4	X-axis I/O connector
CN5	Y-axis I/O connector
CN6	PMC-2HSP/2HSN-USB: USB connector PMC-2HSP/2HSN-485: RS485 connector
IDS	ID selection switch

CN1: Power Connector

Pin no.	Signal name
1	24VDC
2	GND (0V)

CN2: RS232C Connector

Pin no.	Signal name	I/O	Description
1	TXD	Output	Receiving data
2	RXD	Input	Transmitting data
3	GND	—	Ground
4	—	—	N-C
5	—	—	
6	—	—	

※ The internal connection diagram of RS232C communication cable is shown on the right.

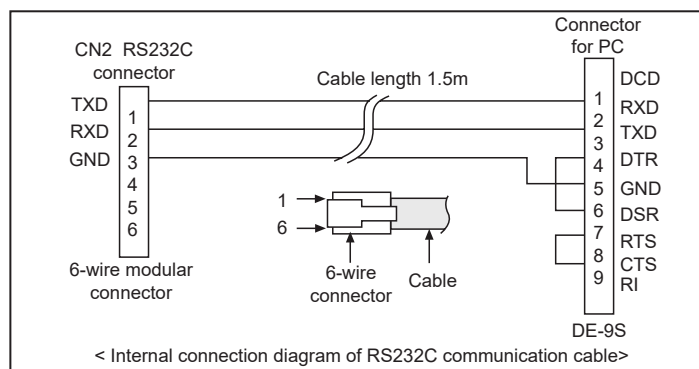

SENSORS

CONTROLLERS

MOTION DEVICES

SOFTWARE

(Y)
Closed Loop
Stepper System

(Z)
Stepper Motors

(AA)
Drivers

(AB)
Motion
Controllers

PMC-2HSP/PMC-2HSN Series

■ CN3: Parallel I/F Connector

The Parallel I/F connector which is connected with a sequencer or mechanical contacts operates motion controller same as PC program. When input signal is ON, the input signal terminal and GEX terminal are connected by mechanical contacts or open collector output and open collector output transistor is ON when the output signal is ON.

Pin no.	Signal name	I/O	Description
1	RESET	Input	Reset
2	HOME	Input	Home search start command
3	STROBE	Input	Drive start command
4	X/JOG Y+	Input	X-axis designate/Jog Y+
5	Y/JOG Y-	Input	Y-axis designate/Jog Y-
6	STEPSL0/RUN+/JOG X+	Input	Register designate 0/Run+/Jog X+
7	STEPSL1/RUN-/JOG X-	Input	Register designate 1/Run-/Jog X-
8	STEPSL2/SPD0	Input	Register designate 2/Drive speed designate 0
9	STEPSL3/SPD1	Input	Register designate 3/Drive speed designate 1
10	STEPSL4/JOG	Input	Register designate 4/Jog designate
11	STEPSL5/STOP	Input	Register designate 5/Drive stop
12	MODE0	Input	Operation mode designate 0
13	MODE1	Input	Operation mode designate 1
14	X DRIVE/END	Output	X-axis drive/Drive end pulse
15	Y DRIVE/END	Output	Y-axis drive/Drive end pulse
16	X ERROR	Output	X-axis error
17	Y ERROR	Output	Y-axis error
18	GEX	—	Ground
19	GEX	—	Ground
20	VEX	—	Power supply for sensor (24VDC, max. 100mA)

<CN3 pin number>

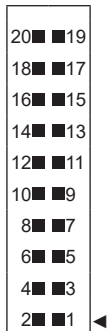

[Hirose connector]: HIF3BA-20PA-2.54DS

[Connector socket specification]: Contact the manufacture for the socket and cable.

	Specifications	Manufacture
Connector socket	HIF3BA-20D-2.54R	Hirose Electric
I/O cable (sold separately)	CO20-HP□-L, CO20-HP□-R	Autonics

■ Input/Output Connections of CN3

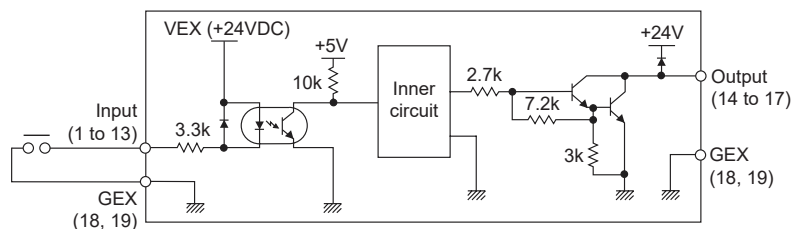

2-axis High Speed Interpolation/Normal Motion Controller

■ CN4, CN5: X, Y-Axis Input/Output Connector

CN4 and CN5 are I/O signals for X-axis and Y-axis respectively.

The pin arrangement of CN4 and CN5 are equal. 'n' in the table means X for CN4 and Y for CN5.

Pin no.	Signal name	I/O	Description
1	n P+P	Output	Drive pulse in the CW + direction
2	n P+N	Output	Drive pulse in the CW - direction
3	n P-P	Output	Drive pulse in the CCW + direction
4	n P-N	Output	Drive pulse in the CCW - direction
5	n OUT0	Output	General output 0
6	n OUT1	Output	General output 1
7	n IN0	Input	General input 0
8	n IN1	Input	General input 1
9	n STOP2	Input	Encoder Z-phase
10	n STOP1	Input	Home
11	n STOP0	Input	Near Home
12	n LMT+	Input	+ direction limit
13	n LMT-	Input	- direction limit
14	EMG	Input	Emergency stop
15	GEX	—	Ground
16	VEX	—	Power supply for sensor (24VDC, max. 100mA)

<CN4, CN5 pin no.>

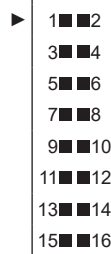

[Hirose connector]: HIF3BA-16PA-2.54DS

[Connector socket specification]: Contact the manufacture for the socket and cable.

	Specifications	Manufacture
Connector socket	HIF3BA-16D-2.54R	Hirose Electric

※CN4, 5 input/output is same as CN3 input/output connections.

Drive pulse output of motion controller which is inputted to motor driver is line driver output.

E.g. Connection with a motor driver

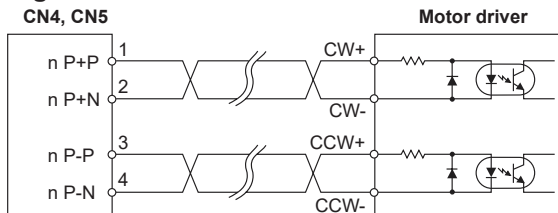

E.g. Connect of Limit and Home signal

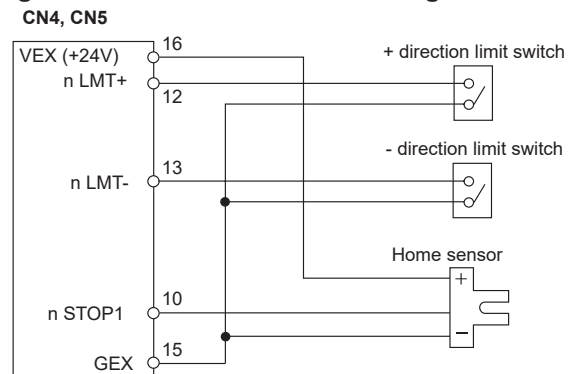

■ CN6: RS485 Connector

Pin no.	Signal name	I/O	Description
1	B (-)	I/O	Transmitting / Receiving data
2	A (+)	I/O	Transmitting / Receiving data
3	G	—	※1

※1: Connect the ground when it is required depending on communication environments.

