

Digital Multicircuit Protector S8M

Complete Flexible DC Circuit Protector That Has a Wide Array of Displays, Alarm Outputs, and Other Digital Functions.

- Four circuit protectors in one package
- Simple setting of current tripping values for each branch outputs in 0.1-A units
- Startup and shutdown sequence control
- Display and alarm functions (Input voltage, output current, run time, and over-temperature)
- Outputs conform to UL Class 2 (at 24 VDC, S8M-CP04-RS only)
- DIN Rail mounting
- Free Support Tool available



Note: Refer to *Precautions for Safe Use* on page 20.

Model Number Structure

■ Model Number Legend

Note: Not all combinations are possible. Please refer to the list of models in *Ordering Information* below.

S8M-CP04-
 1 2

1. Communications

- None: Not supported
- R: Supported (RS-232)

2. UL Class 2 Output (at 24 VDC)

- None: Not compliant
- S: Compliant

Ordering Information

Note: For details on normal stock models, contact your nearest OMRON representative.

Communications	UL Class 2 output	Model number
None	Not compliant	S8M-CP04
Supported (RS-232C)	Not compliant	S8M-CP04-R
	Compliant	S8M-CP04-RS

Recommended Power Supplies

Series name	Model number
S8VS	S8VS-06024□□
	S8VS-09024□□
	S8VS-12024□□
	S8VS-18024□□
	S8VS-24024□□
S8VM	S8VM-05024□□
	S8VM-10024□□
	S8VM-15024□□
	S8VM-30024C
	S8VM-60024C

Note: When selecting the power supply, be sure to include the internal power consumption of the S8M (approx. 10 W) and not just the power consumption of the load.

This Datasheet describes only the minimum setting operations required when using the S8M for the first time. Refer to the *S8M User's Manual* (Cat. No. Z241), when making further settings.

Specifications

■ Ratings/Characteristics

Item	Model	S8M-CP04	S8M-CP04-R	S8M-CP04-RS	
Number of branches		4			
I/O characteristics	Rated input voltage	24 VDC (19.2 to 26.4 VDC)			
	Allowable input current	17.0 A max.		16.0 A max.	
	Maximum tripping output current (per branch output)	4.0 A		3.8 A	
	Internal voltage drop (See note 1.)	0.5 VDC max. (at 4.0 A)		0.7 VDC max. (at 3.8 A)	
	Output leakage current	10 mA max.			
	Power consumption (See note 2.)	4 branches output, normal operation	10 W max. (at 4.0 A)		15 W max. (at 3.8 A)
4 branches output, tripping operation		3 W max.			
Functions	Tripping	Abnormal voltage tripping	28.8 V (fixed), tripping alarm output		
		Abnormal current tripping	Setting range: 0.5 to 4.0 A (in 0.1-A units), tripping alarm output	Setting range: 0.5 to 3.8 A (in 0.1-A units), tripping alarm output	
		Tripping alarm output	Transistor output 30 VDC max., 50 mA max., leakage current: 0.1 mA max., residual voltage: 2 V max.		
	Alarms	Overvoltage	Setting range: 20.0 to 28.8 V (in 0.1-V units), alarm output		
		Undervoltage	Setting range: 18.0 to 26.4 V (in 0.1-V units), alarm output		
		Overcurrent	Setting range: 0.5 to 4.0 A (in 0.1-A units), alarm output		Setting range: 0.5 to 3.8 A (in 0.1-A units), alarm output
		Run time	Setting range: 0.0 to 99.9 kh (in 0.1-kh units), alarm output (The alarm output is disabled if the time is set to 0.0 kh.)		
		Alarm output	Transistor output 30 VDC max., 50 mA max., leakage current: 0.1 mA max., residual voltage: 2 V max.		
	Temperature	Temperature	Setting range: 25 to 80°C, over-temperature output		
		Over-temperature output	Transistor output 30 VDC max., 50 mA max., leakage current: 0.1 mA max., residual voltage: 2 V max.		
	Display	Input voltage	Display range: 17.0 to 30.0 V Display accuracy: 2% rdg ±1 digit max.		
		Output current	Branch output display range: 0.0 to 4.0 A Peak output current display range: 0.0 to 10.0 A Total current display range: 0.0 to 40.0 A Display accuracy: 5% FS (4 A) ±1 digit max.		
		Run time	Display range: 0.0 to 99.9 kh Display accuracy: 2% rdg ±1 digit max.		
		Temperature	Display range: -10 to 100°C Display accuracy: 2°C ±1 digit max.		
	External tripping input		19.2 to 30 VDC, minimum signal width: 10 ms, tripping within 20 ms of input		
Startup sequence		Can be enabled/disabled for each branch output, setting range: 0.0 to 99.9 s in 0.1-s units.			
Shutdown sequence		Can be enabled/disabled for each branch output, setting range: 0.0 to 99.9 s in 0.1-s units.			
Communications		None	Supported (RS-232C)		
Sampling period		1 ms			

Item	Model	S8M-CP04	S8M-CP04-R	S8M-CP04-RS	
Other	Ambient operating temperature	Refer to the derating curve in <i>Engineering Data</i> (with no condensation or icing) (See note 3.)			
	Storage temperature	-25 to 65°C			
	Ambient operating humidity	25% to 85% (storage humidity: 25% to 90%)			
	Dielectric strength	1.0 kVAC for 1 min (between all charged sections and all non-charged sections; detection current: 20 mA) 500 VAC for 1 min (between all I/O and I/O signals/communications; detection current: 20 mA) 500 VAC for 1 min (between all I/O signals and communications; detection current: 20 mA) 500 VAC for 1 min (between input signals and all output signals; detection current: 20 mA)			
	Insulation resistance	100 MΩ min. (between all charged sections and all non-charged sections) at 500 VDC 100 MΩ min. (between all I/O and I/O signals/communications) at 500 VDC 100 MΩ min. (between all I/O signals and communications) at 500 VDC 100 MΩ min. (between input signals and all output signals) at 500 VDC			
	Vibration resistance	10 to 55 Hz, 0.375-mm single amplitude for 2 h each in X, Y, and Z directions			
	Shock resistance	150 m/s ² , 3 times each in ±X, ±Y, and ±Z directions			
	EMI	Conducted Emission	Conforms to EN 61204-3 Class B		
		Radiated Emission	Conforms to EN 61204-3 Class B		
	EMS	Conforms to EN 61204-3 High severity levels			
	Approved standards	UL: UL 508 (Listing), UL 60950-1 cUL: CSA C22.2 No. 107.1 cUR: CSA No. 60950-1 EN/VDE: EN 50178 (= VDE 0160), EN 60950-1 (= VDE 0805 Teil 1)		UL: UL 508 (Listing, Class 2: Per UL 1310), UL60950-1 cUL: CSA C22.2 No. 107.1 cUR: CSA No. 60950-1 EN/VDE: EN 50178 (= VDE 0160), EN 60950-1 (= VDE 0805 Teil 1)	
Weight	400 g max.				

- Note:**
1. A voltage drop will occur in the S8M. Consider the voltage drop at the output.
 2. When selecting the power supply, be sure to include the internal power consumption of the S8M (approx. 10 W) and not just the power consumption of the load.
 3. Refer to *Engineering Data* on page 6 for details.

Connections

■ Block Diagrams

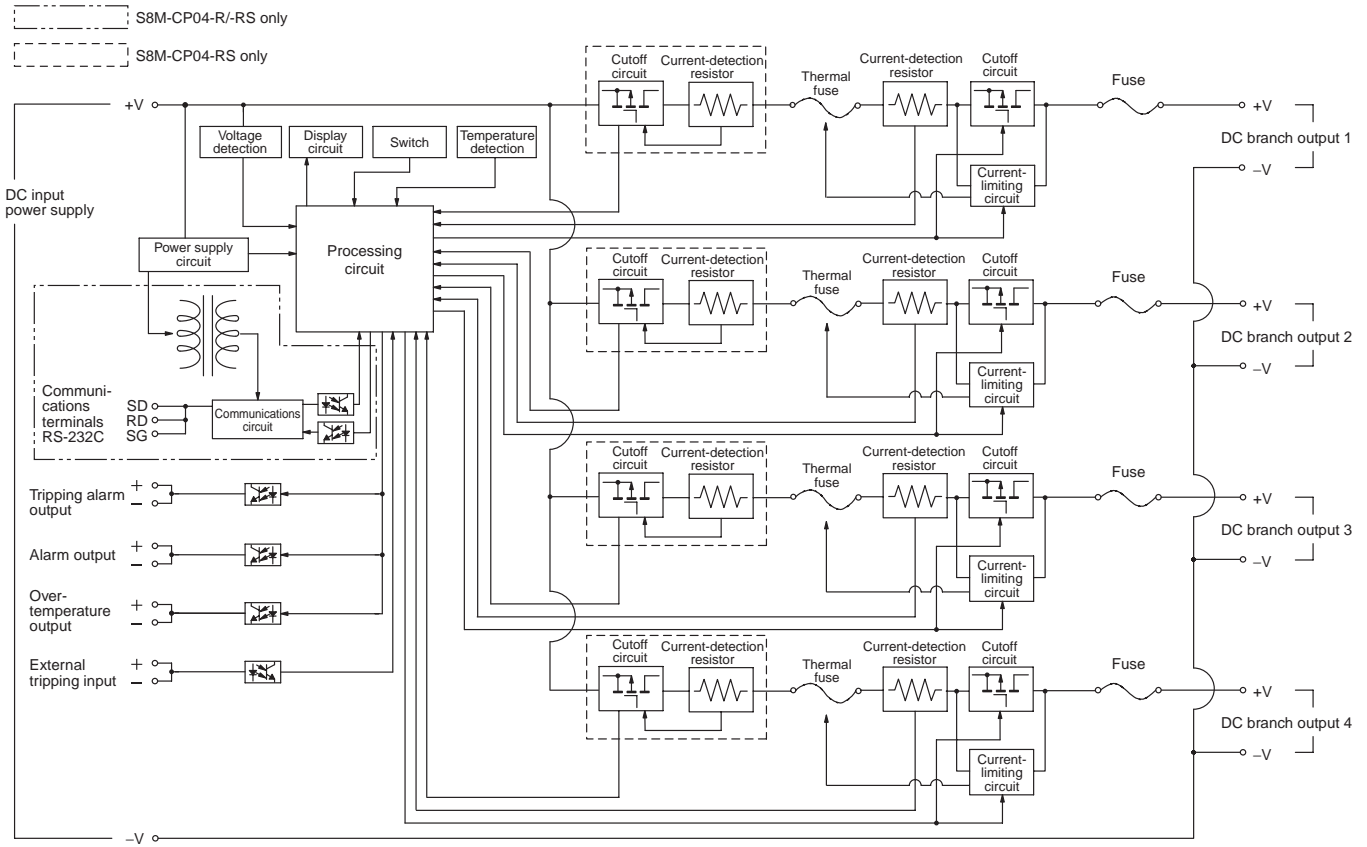

Construction and Nomenclature

Nomenclature

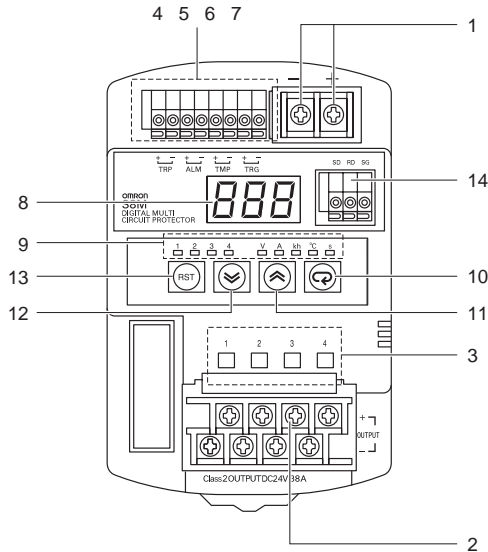

Note: The S8M-CP04-RS is shown above.

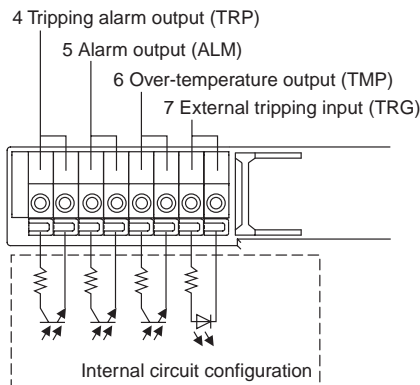

No.	Name	Function	
1	Power Input Terminals (+V), (-V)	Connect to the input line.	
2	Branch Output Terminals (+V), (-V)	Connect to the load lines. Up to four branch outputs can be connected.	
3	Status Indicators (Red, Green)	Indicate the connection and cutoff status for each branch output. Cut off: Red, Connected: Green (See note 1.)	
4	Tripping Alarm Output (+, -)	Output (transistor: OFF) when the error tripping operation functions. (See note 2.)	
5	Alarm Output (+, -)	Output (transistor: OFF) when a set value for alarm detection is exceeded. (See note 2.)	
6	Over-temperature Output (+, -)	Output (transistor: OFF) when a set value for over-temperature detection is exceeded. (See note 2.)	
7	External Tripping Input (+, -)	The tripping operation can be executed with an externally input signal.	
8	Seven-segment Display (Red)	Displays measured values and set values.	
9	Unit Indicators (Orange)	V	Lit when the input voltage is being displayed.
		A	Lit when the output current is being displayed. Flashes when the peak output current is being displayed.
		kh	Lit when the run time is being displayed.
		°C	Lit when the temperature is being displayed.
		s	Lit when setting the sequence time.
1 to 4		Lit or flashing when displaying branch output information. (See note 3.)	
10	Mode Key	Used to change the parameter being displayed or to reset the peak hold current value.	
11	Up Key	Used to move to different setting modes or to increase a set value.	
12	Down Key	Used to move to different setting modes or to decrease a set value.	
13	Reset Key (RST)	Used when connecting branch outputs for tripping operation. (See note 4.)	
14	Communications Terminals (RD, SD, SG)	Connect to the communications lines (RS-232C). (See note 5.)	

- Note:**
- For detailed display methods, refer to *Status Indicators* on page 13.
 - Configured from independent circuits, and either sinking or sourcing applications are possible.
 - Indicators 1 to 4 will not light except when the current is being displayed.
 - Press for at least 3 s to enable operation.
 - Except for the S8M-CP04.

Engineering Data

Derating Curve

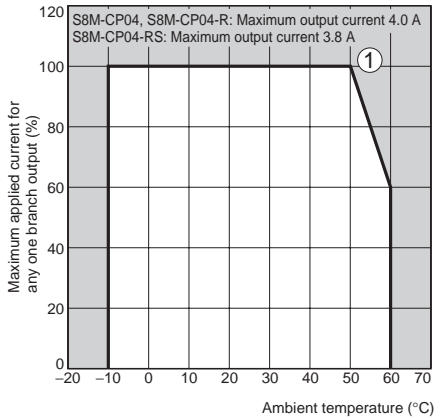

Derating Curve of the S8M

The ambient temperature that S8M can be operating is limited by the maximum output current of one branch terminal on ordinary current condition.

- Note:**
1. Internal parts may occasionally be deteriorated or damaged. Do not use the S8M in areas outside the derating curve (i.e., in the area shown by shading ① in the above graph).
 2. If there is a derating problem, use forced air cooling.

Abnormal Current Tripping

Standard Detection

S8M-CP04/S8M-CP04-R

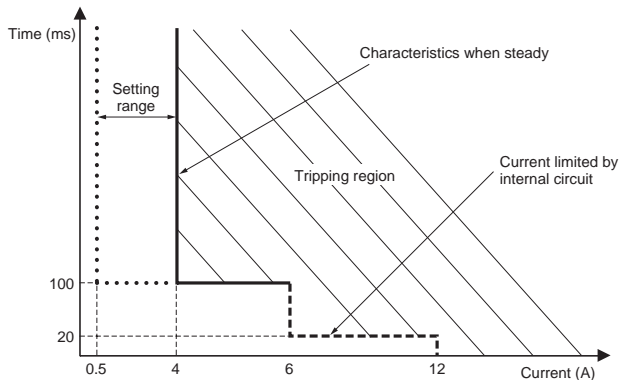

S8M-CP04-RS

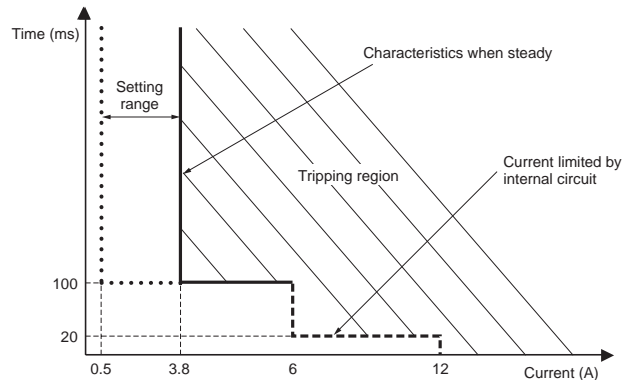

Instantaneous Detection

S8M-CP04/S8M-CP04-R

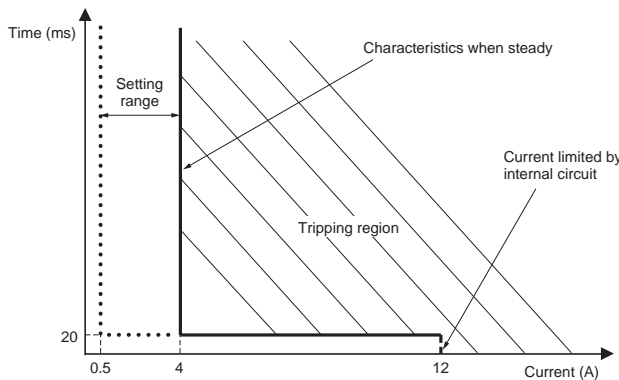

S8M-CP04-RS

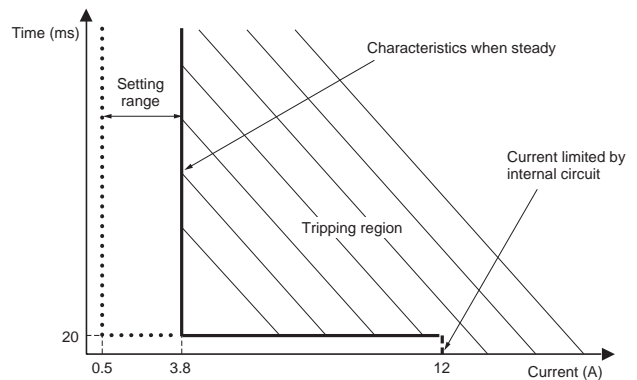

■ Mounting

Standard Mounting

Correct

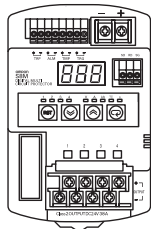

Face-up Mounting

Incorrect

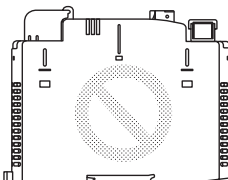

Note: 1. Improper mounting will interfere with heat dissipation and may occasionally result in deterioration or damage of internal parts. Do not use any mounting method other than the standard one.

2. Take adequate measures to ensure proper heat dissipation to increase the long-term reliability of the S8M.
3. Install the S8M so that the air flow circulates around it, because the S8M is designed to radiate heat by means of natural air flow.

Functions

■ Functions

Alarm	Alarm output	Output status	Alarm display
Abnormal voltage tripping	TRP output: OFF (normally ON)	All branch outputs cut off.	A10
Abnormal current tripping	TRP output: OFF (normally ON)	Relevant branch output cut off.	A11
Overvoltage alarm	ALM output: OFF (normally ON)	ON	A20
Undervoltage alarm	ALM output: OFF (normally ON)	ON	A21
Overcurrent alarm	ALM output: OFF (normally ON)	ON	A22
Run time alarm	ALM output: OFF (normally ON)	ON	A23
Over-temperature output	TMP output: OFF (normally ON)	ON	A30

■ Tripping Functions

Function	Operation
Abnormal voltage tripping Refer to <i>Chart 1</i> . (See notes 2, 3 and 4.)	The input voltage is monitored and all branch outputs are cut off if the detection voltage is reached. Notification of the status is provided using the alarm display and the tripping alarm output (TRP). The alarm display will alternate between the voltage and the alarm code (A10). The primary voltage is measured at the input terminals. Detection voltage: 28.8 V (fixed)
Abnormal current tripping Refer to <i>Chart 2</i> . (See notes 2 and 3.)	The output current is monitored and the branch output that is abnormal is cut off if the preset current is reached. Notification of the status is provided using the alarm display and the tripping alarm output (TRP). The alarm display will alternate between the current and the alarm code (A11). Abnormal current detection setting range: 0.5 to 4.0 A (S8M-CP04-RS: 0.5 to 0.38 A) in 0.1-A units. <u>Either of two abnormal current tripping types can be set.</u> Standard detection: Tripping within 100 ms. (If a current exceeding the set value flows for 80 ms or more, it is detected as an abnormal current and power is cut off within 20 ms.) Instantaneous detection: Tripping within 20 ms. (If a current exceeding the set value flows for 10 ms or more, it is detected as an abnormal current and power is cut off within 10 ms.) (Refer to page 14 for the setting procedure.)
Tripping by external signal (See note 2.)	The output can be cut off by inputting a voltage to the external tripping input (TRG terminal). If a shutdown sequence has been set, outputs will be cut off according to the shutdown sequence. (Refer to page 14 for information on the shutdown sequence.) External input signal width: 10 ms min. External tripping enable/disable setting: Enabled Input signal levels High level: 19.2 to 30 VDC Low level: 0 to 2.5 VDC Tripping can also be performed by using communications (S8M-CP04-R/RS only). Refer to the <i>S8M User's Manual</i> (Cat. No. Z241) for information on tripping using communications.

- Note:**
- Two abnormal current tripping types are supported depending on the tripping current characteristics: Standard detection and instantaneous detection. Select the required tripping type.
 - Outputs are cut off using semiconductor relays and electrical insulation is not provided.
 - The output will remain OFF and the alarm display and alarm output will not be cleared even if power is restored. The S8M must be reset to restore operation. (Refer to *List of Alarms* on page 16 for details.)
 - The voltage at the power input terminals is monitored to detect abnormal voltages. To confirm correct output voltages, measure the voltages at the branch output terminals.

Chart 1: Operation Timing

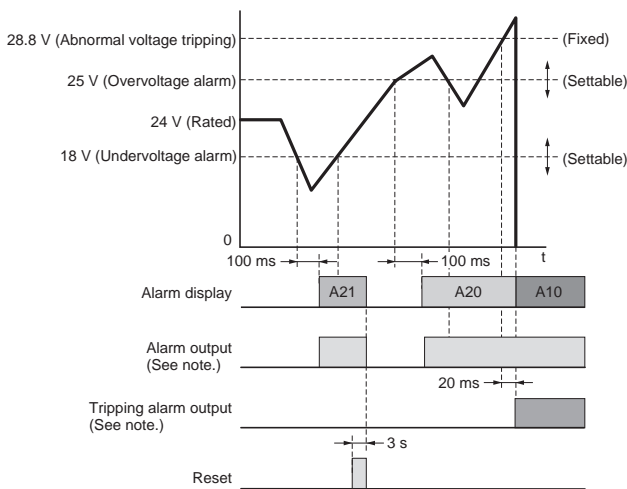

Note: The alarm and tripping alarm output are both transistor outputs. It is normally ON and turns OFF when an alarm is detected.

Chart 2: Operation Timing

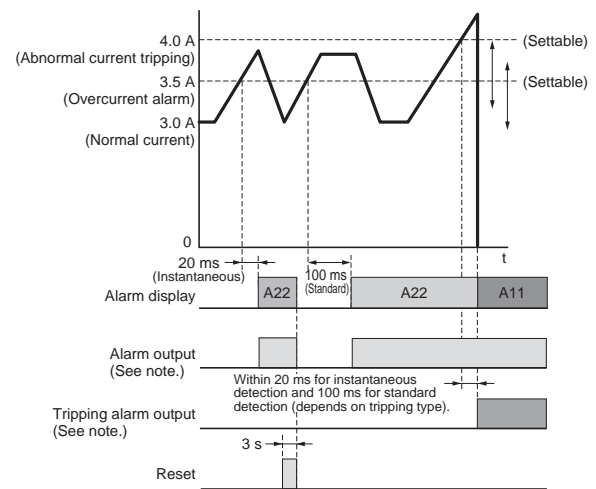

Note: The alarm and tripping alarm output are both transistor outputs. It is normally ON and turns OFF when an alarm is detected.

Alarm Functions

Function	Operation
Overvoltage alarm (Refer to <i>Chart 1</i> .) (See notes 1 and 2.)	The voltage is monitored and notification is provided using the alarm display and output (ALM) if the preset voltage is exceeded for more than 100 ms. The alarm display will alternate between the voltage and the alarm code (A20). The primary voltage is measured at the input terminals. Overvoltage alarm setting range: 20.0 to 28.8 V in 0.1-V units. (Refer to page 14 for the setting procedure.)
Overcurrent alarm (Refer to <i>Chart 2</i> .) (See note 1.)	Each branch output current is monitored and notification is provided using the alarm display and output (ALM) if the preset value is reached. The alarm display will alternate between the current and the alarm code (A22). Overcurrent alarm setting range: 0.5 to 4.0 A (S8M-CP04-RS: 0.5 to 0.38 A) in 0.1-A units. Either of two tripping types can be set. Standard detection: An alarm is output if the current exceeds the set value for 80 ms or longer. Instantaneous detection: An alarm is output if the current exceeds the set value for 10 ms or longer. (Refer to page 14 for the setting procedure.)
Undervoltage alarm (Refer to <i>Chart 1</i> .) (See notes 1 and 2.)	The voltage is monitored and notification is provided using the alarm display and output (ALM) if the voltage drops below the preset voltage for more than 80 ms. The alarm display will alternate between the voltage and the alarm code (A21). The primary voltage is measured at the input terminals. Undervoltage alarm setting range: 18.0 to 26.4 V in 0.1-V units. (Refer to page 14 for the setting procedure.)
Run time alarm (Refer to <i>Chart 3</i> .) (See note 1.)	The time that the power is turned ON is calculated as the S8M run time and notification is provided using the alarm display and output (ALM) if the preset time is reached. The alarm display will alternate between the run time and the alarm code (A23). Display range: 0.0 to 99.9 kh in 0.1-kh units. Run time setting range: 0.0 to 99.9 kh in 0.1-kh units. (Refer to page 14 for the setting procedure.)
Over-temperature output (Refer to <i>Chart 4</i> .) (See note 1.)	The internal temperature of the S8M is monitored using a built-in temperature sensor and notification is provided using the alarm display and over-temperature output (TMP) if the preset temperature is exceeded for more than 1 s. The alarm display will alternate between the temperature and the alarm code (A30). The over-temperature output is convenient for control operations, such as operating a cooling fan to suppress temperature increased in the control panel. Note: The alarm display and over-temperature output are automatically cleared if the temperature falls below the set temperature. Display range: -10 to 100°C in 1°C units. Temperature setting range: 25 to 80°C in 1°C units. (Refer to page 14 for the setting procedure.)

Note: 1. Branch outputs are not cut off for the alarm functions.

2. The voltage at the power input terminals is monitored to detect abnormal voltages. To confirm correct output voltages, measure the voltages at the branch output terminals.

Chart 3: Operation Timing

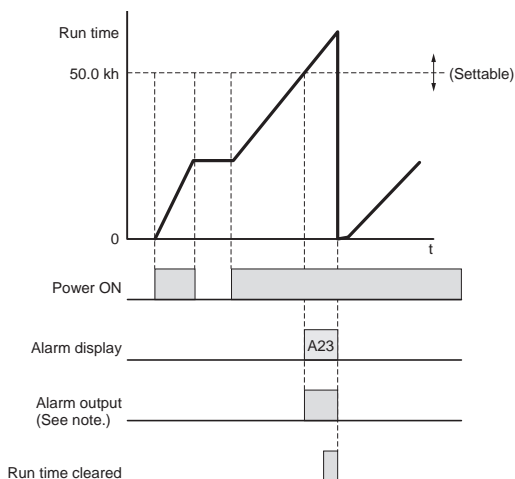

Note: The alarm output is a transistor output. It is normally ON and turns OFF when an alarm is detected.

Chart 4: Operation Timing

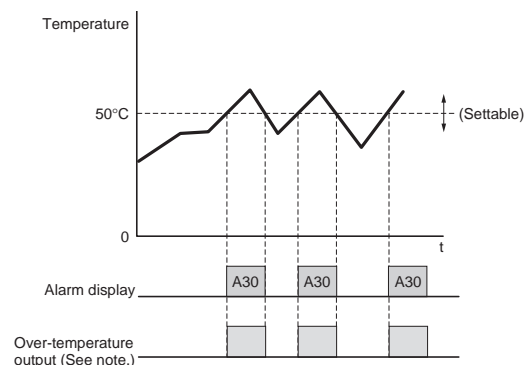

Note: The alarm display and over-temperature output are automatically cleared (with hysteresis). (Refer to page 16.) The over-temperature output is a transistor output. It is normally ON and turns OFF when an alarm is detected.

Other Functions

Function	Operation
Startup sequence (Refer to <i>Chart 5</i> .)	The connection timing for branch outputs 1 to 4 can be set individually to offset the connection timing of load devices. Creating time delays between starting loads enables safe load operation. It also reduces total inrush current so that power supply capacity can be optimized. Setting range: 0.0 to 99.0 s in 0.1-s units. (See note.) (Refer to page 14 for the setting procedure.)
Shutdown sequence (Refer to <i>Chart 6</i> .)	The cutoff timing for branch outputs 1 to 4 can be set individually to offset the cutoff timing of load devices for the external tripping input or to enable an emergency stop. Setting range: 0.0 to 99.0 s in 0.1-s units. (See note.) (Refer to page 14 for the setting procedure.)
Startup delay	A delay function is provided so that the abnormal current tripping function or overcurrent alarm function will not be triggered by large initial surge currents, e.g., for capacitive loads or lamp loads. The abnormal current tripping function will function once the set time has elapsed. (Note: The delay is fixed at 70 ms.)

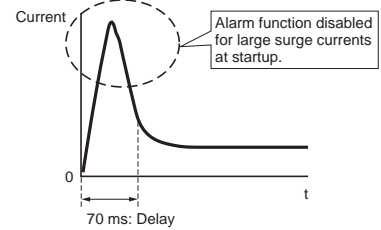

Note: The sequencing functions are designed for the four branch outputs of one S8M. There is no sync processing between S8M Protectors when more than one S8M is used.

Chart 5: Operation Timing

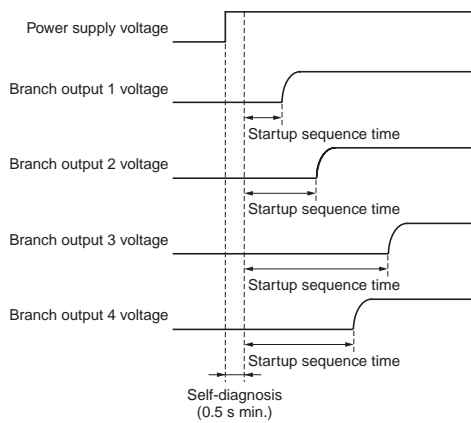
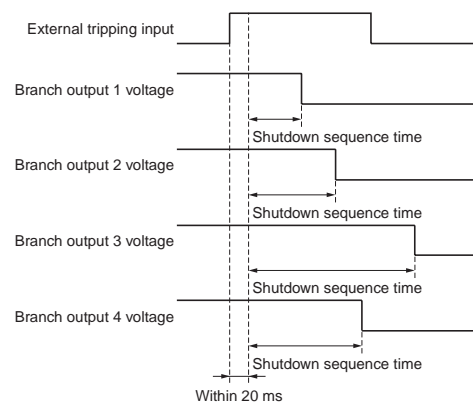
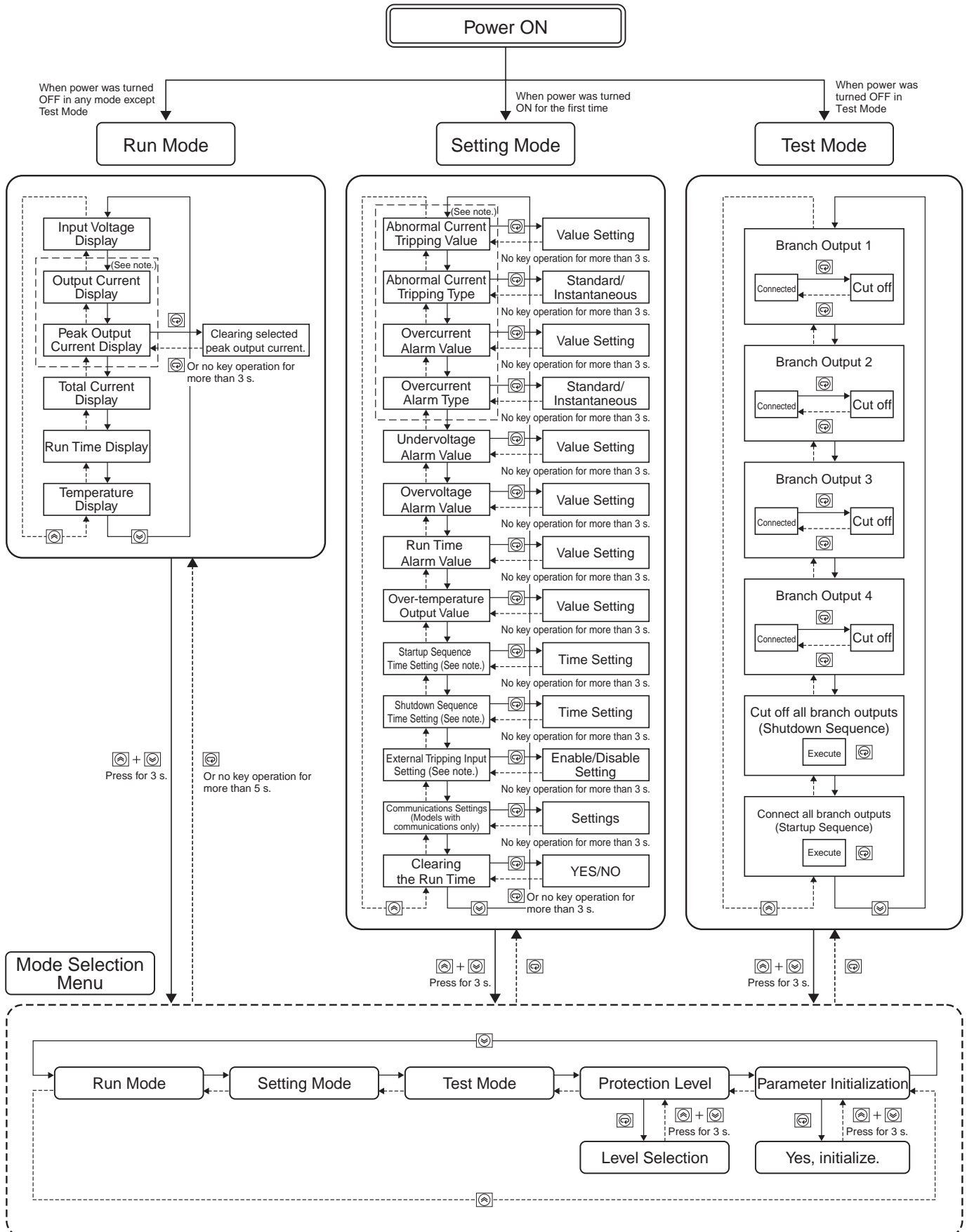

Chart 6: Operation Timing



Note: Tripping operation is simultaneous for tripping made for abnormal voltages (28.8 V or higher).

Key Operations and Displays in Each Mode



Note: Settings are displayed in order for branch outputs 1 to 4. Specific branch output settings have been omitted.

Mode Descriptions

The S8M supports a Run Mode, Setting Mode, and Test Mode.

Run Mode	Used for normal operation.
Setting Mode	Used to set or change S8M parameters.
Test Mode	Used to test operation for devices connected to the S8M.

Note: Refer to the *S8M User's Manual* (Cat. No. Z241), when having further setting.

Initial Settings When First Using the S8M

The following diagram illustrates mode transitions for the S8M. When the S8M is turned ON for the first time, it will enter Setting Mode. First set the required initial settings for the parameters in Setting Mode and then switch to Test Mode or Run Mode.

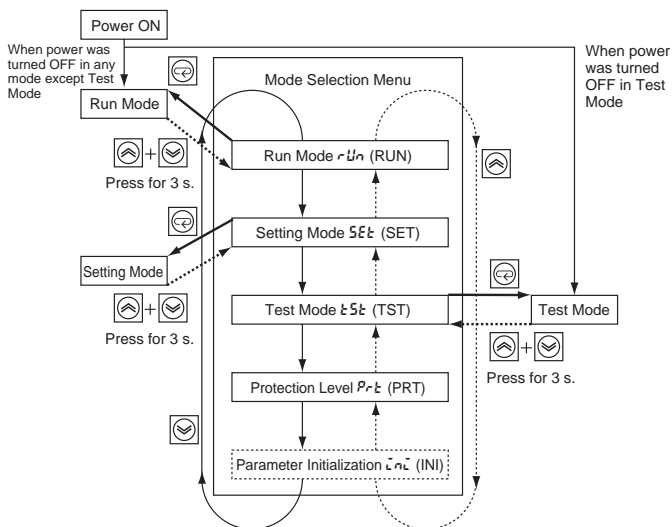

Mode Selection Menu

The following modes can be selected from the Mode Selection Menu using the Up and Down Keys.

(1) Run Mode

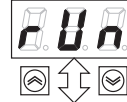

In Run Mode, the current, input voltage, and other values are displayed for the branch outputs. Use this mode for operation once initial settings and system adjustments have been completed.

(2) Setting Mode



Setting Mode is used to set parameters. Operation starts from this mode when using the S8M for the first time.

(3) Test Mode



Test Mode enables forcing branch outputs ON and OFF. Connections and cutoffs can be manipulated for all outputs for each branch output. By default, all outputs will be OFF. Test Mode is thus used to turn ON branch outputs as required.

(4) Protection Level

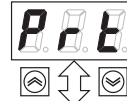

Protection Level can be used to set restrictions for reading and writing parameters. Three levels, levels 0, 1, and 2, are available. The default is level 1. Refer to the *S8M User's Manual* (Cat. No. Z241) for the parameters that are protected in each level.

(5) Parameter Initialization



Parameter Initialization is used to return all parameters to their default settings. The Parameter Initialization is not displayed in the default protection level (level 1), and the protection level must be set to level 0 to initialize parameters. Refer to the *S8M User's Manual* (Cat. No. Z241) if initialization is required.

Run Mode

Run Mode is used for normal operation. When the input power is turned ON and the mode was Run Mode or Setting Mode the last time the input power was turned OFF, the S8M will start in Run Mode and connecting the branch outputs will be started. Monitoring of the voltages, currents, run time, and temperature can be confirmed using the Up Key and Down Key (▲ and ▼).

(1) Input Voltage Display

The input voltage is monitored and displayed.

(2) Output Current Display for Branch Output 1

The output current for a branch output is displayed.

(3) Peak Output Current Display for Branch Output 1

The peak output current for a branch output is displayed. The output currents and peak output currents for branch outputs 2 to 4 are displayed next.

(4) Total Current Display

The total current for all four branch outputs is displayed.

(5) Run Time Display

The S8M run time is displayed.

(6) Temperature Display

The temperature inside the S8M is displayed.

- Note:**
1. The S8M will start in Setting Mode when power is turned ON for the first time after shipping from the factory.
 2. Settings cannot be changed in Run Mode. Use Setting Mode to change settings.
 3. If a startup sequence has been set, connections will be started according to the set delays.
 4. When moving to Run Mode, the branch output ON/OFF status from before entering Run Mode will be maintained. When switching to Run Mode from Test Mode, first turn ON all of the branch outputs.
 5. The voltage detection function monitors the voltage at the power input terminals. Measure the voltage at the branch output terminals to confirm that the output voltage is correct.

Status Indicators

The status indicators light according to the branch output status as described below.

Lit green	Normal connection status
Flashing green	Connection standby status during the startup sequence
Lit red	Cutoff status for an abnormality
Flashing red	Cutoff status for a redundant protection circuit with Class 2 specifications
Not lit	Forced cutoff or operation stopped

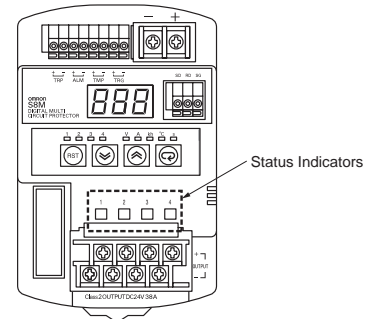

Clearing the Peak Output Currents

The peak output currents can be cleared. Select the peak output current to be cleared in Run Mode and then use the following operation.

Peak Output Current Display

Waiting display, 1 s

or
3 s with
no key operations

Clearing completed.

After flashing for 3 s

Set value saved (flashes for 3 s)

Note: Indicator Status Notation

■ : Lit □ : Flashing

Setting Mode

Setting Mode is used to set S8M parameters. Settings can be read or changed while operation continues. The various parameters can be selected as shown below.

C-V	Abnormal Current Tripping Value	The current at which a branch output is cut off. Setting range: 0.5 to 4.0 A (S8M-CP04-RS: 0.5 to 3.8 A) The branch output will be cut off if the value set here is exceeded.
C-T	Abnormal Current Tripping Type (See note 4.)	Detection settings for currents to cut off branch outputs. Standard detection/instantaneous detection
A-V	Overcurrent Alarm Value	The current at which an alarm is output. Setting range: 0.5 to 4.0 A (S8M-CP04-RS: 0.5 to 3.8 A) An alarm will be output if the value set here is exceeded.
A-T	Overcurrent Alarm Type (See note 4.)	Detection settings for currents to cut off branch outputs. Standard detection/instantaneous detection
V-U	Undervoltage Alarm Value	The detection value for a voltage drop at which an alarm is output. Setting range: 18.0 to 26.4 V An alarm will be output if the voltage drops below the value set here.
V-O	Overvoltage Alarm Value	The detection value for a voltage rise at which an alarm is output. Setting range: 20.0 to 28.8 V An alarm will be output if the voltage rises above the value set here.
TIM	Run Time Alarm Value	The run time at which an alarm is output. Setting range: 0.0 to 99.9 kh An alarm will be output if the value set here is exceeded. The alarm will be disabled if the alarm value is set to 0.0.
TMP	Over-temperature Output	The temperature at which a signal is output. Setting range: 25 to 80°C An over-temperature signal will be output if the value set here is exceeded.
UPS	Startup Sequence (See note 4.)	Enable/disable the startup sequence and set the time for each branch output. Time setting range: 0.0 to 99.9 s
DWS	Shutdown Sequence (See note 4.)	Enable/disable the shutdown sequence and set the time for each branch output. Time setting range: 0.0 to 99.9 s

TRG	External Tripping Input (See note 4.)	Enable/disable the external tripping input
UNO	Unit No.	Unit number setting (0 to 31)
BPS	Baud Rate	Baud rate setting 48: 4,800 bps, 96: 9,600 bps
LEN	Bit Length	Bit length setting (7 or 8)
BIT	Stop Bits	Stop bit setting (1 or 2)
PTY	Parity	Parity setting non: None, evn: Even, odd: Odd
SWT	Send Wait Time	Send wait time setting 0 to 999 ms
CLR	Clearing the Run Time (See note 5.)	The run time can be cleared.

- Note:**
- Parameters cannot be changed in protection level 2.
 - The S8M will start in Setting Mode when power is turned ON for the first time after shipping from the factory.
 - Refer to the *S8M User's Manual* (Cat. No. Z241), when having further settings.
 - Not displayed in protection level 1 or 2.
 - Not displayed in protection level 2.

Clearing the Run Time

The run time can be cleared. Select the run time to be cleared in Run Mode and then use the following operation.

Setting Parameters

Parameters are set as shown below.

Example for Setting the Abnormal Current Tripping Value

Use to change the set value.

After no key operations for 3 s

When finished, press to save the set value.

Set value saved (flashes for 3 s).

After flashing for 3 s

Note: Indicator Status Notation
 : Lit : Flashing

Clearing the Run Time

Waiting display, 1 s



After flashing for 3 s

Set value saved (flashes for 3 s)

Test Mode

Device startup operation can be tested by turning ON/OFF branch outputs either individually or together. The branch outputs that are to be used are set to be connected in Test Mode. The operation to turn all branch outputs ON/OFF together can be used to check startup and shutdown sequences.

1. Turning ON/OFF Individual Branch Outputs

The following display will appear when Test Mode is entered and the Up and Down Keys ( and ) can be used to select the branch output. Set the branch output number to be output, confirming the number on the mode indicators, and then turn ON the output. The ON/OFF (connected/cut off) status of the branch outputs can be confirmed on the status indicators. An indicator will light green if the output is connected normally.

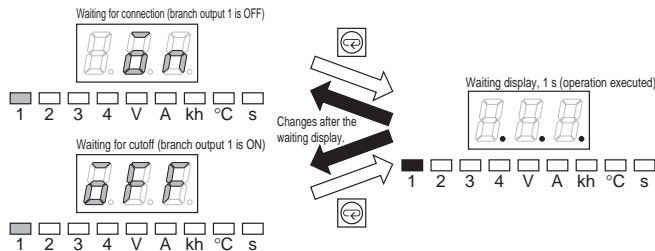

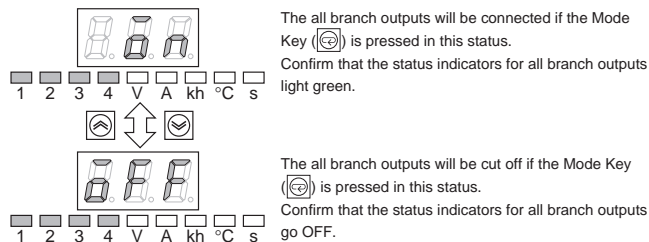

2. Turn ON/OFF All Branch Outputs

The Up and Down Keys ( and ) can also be used to select all branch output numbers. The ON or OFF display will appear. Use the Mode Key to execute the operation.



Note: Test Mode can be entered only in protection level 0 or 1. It cannot be entered in protection level 2.

Note: Indicator Status Notation
 : Lit  : Flashing

Protection Level Setting

A protection level can be set to prevent operating errors during normal operation. Reading or changing parameter settings and other operations can be restricted in three levels.

Protection Level	Intended for	Possible operations
0	Facility designers and manufacturers	All settings can be read and changed.
1	Facility maintenance personnel	Some settings can be read and changed.
2	On-site operators	Settings can be read but not changed.

Select **PRT** (protection level) from the Mode Selection Menu and then perform the following procedure. (The following example shows changing to protection level 0.)

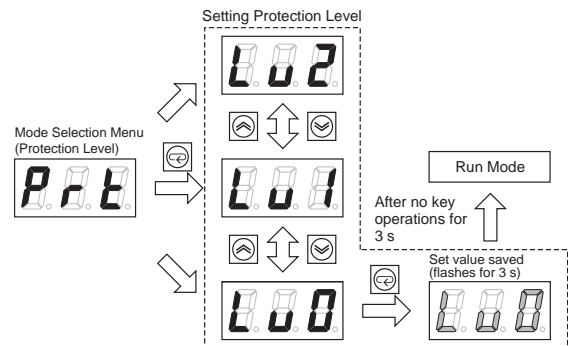

Parameter Initialization

All S8M parameters can be restored to their default settings. Set protection level 0 and then go to the Mode Selection Menu. **INI** (parameter initialization) will be added to the menu. Select **INI** and then perform the following procedure.

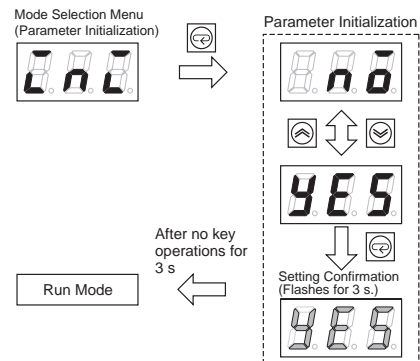

Note: 1. The Mode Selection Menu is not displayed in protection level 1 or 2. The default setting is for protection level 1.

2. Default Settings

- The operating mode will change to Setting Mode.
- The parameters will change to their default settings.
- All branch outputs will be changed so they are not connected.
- The protection level will change to level 1.

■ List of Alarms

Alarm display	Name	Alarm outputs	Power outputs	Recovery/reset method
A10	Abnormal voltage tripping	TRP output: OFF (normally ON)	Cut off	Remove the cause of the abnormality and then press the Reset Key (Ⓜ) on the front panel for at least 3 s or use communications reset function (S8M-CP04-R/RS only). Power supply will be restarted after recovery. Note: 1. Resetting will be possible from 15 s after the output is cut off. 2. Cutoff and alarm status will not be reset even if the power supply is reset.
A11	Abnormal current tripping	TRP output: OFF (normally ON)	Cut off	Remove the cause of the abnormality and then press the Reset Key (Ⓜ) on the front panel for at least 3 s or use communications reset function (S8M-CP04-R/RS only). Power supply will be restarted after recovery. Note: 1. Resetting will be possible from 15 s after the output is cut off. 2. Cutoff and alarm status will not be reset even if the power supply is reset.
A20	Overvoltage alarm	ALM output: OFF (normally ON)	ON	Remove the cause of the alarm and then press the Reset Key (Ⓜ) on the front panel for at least 3 s or use communications reset function (S8M-CP04-R/RS only). Run Mode will be returned to after the alarm is reset. Note: 1. Resetting will be possible if the voltage remains below the set value minus 0.3 V for at least 500 ms from 15 s after the alarm occurs. 2. The alarm status will be reset if the cause of the alarm has been removed when the power supply is reset.
A21	Undervoltage alarm	ALM output: OFF (normally ON)	ON	Remove the cause of the alarm and then press the Reset Key (Ⓜ) on the front panel for at least 3 s or use communications reset function (S8M-CP04-R/RS only). Run Mode will be returned to after the alarm is reset. Note: 1. Resetting will be possible if the voltage remains above the set value plus 0.3 V for at least 500 ms from 15 s after the alarm occurs. 2. The alarm status will be reset if the cause of the alarm has been removed when the power supply is reset.
A22	Overcurrent alarm	ALM output: OFF (normally ON)	ON	Remove the cause of the alarm and then press the Reset Key (Ⓜ) on the front panel for at least 3 s or use communications reset function (S8M-CP04-R/RS only). Run Mode will be returned to after the alarm is reset. Note: 1. Resetting will be possible if the current remains below the set value for at least 500 ms from 15 s after the alarm occurs. 2. The alarm status will be reset if the cause of the alarm has been removed when the power supply is reset.
A23	Run time alarm	ALM output: OFF (normally ON)	ON	Perform the run time clear operation in Setting Mode. CLR (run time clear) will be displayed on the Setting Mode Menu and YES/NO will be displayed when the Mode Key (Ⓜ) is pressed. The run time will be cleared if the Mode Key (Ⓜ) is pressed again when Yes is displayed. Note: CLR (run time clear) will not be displayed on the Setting Mode Menu in protection level 2. Change the protection level to level 0 or 1 using the Protection Mode Selection Menu and then clear the run time.
A30	Over-temperature output	TMP output: OFF (normally ON)	ON	The alarm display and over-temperature output will automatically be reset if the temperature remains below the set value minus 3°C for at least 5 s.

Note: Alarms will be displayed in order of priority if more than one alarm occurs at the same time.
Order of priority: A10, A11, A20, A21, A22, A23, A30.

Alarm Display

The S8M displays alarms according to the parameters set in Setting Mode. The alarm number and detected value are alternated on the display for each alarm.

Example: Abnormal Current Tripping Alarm

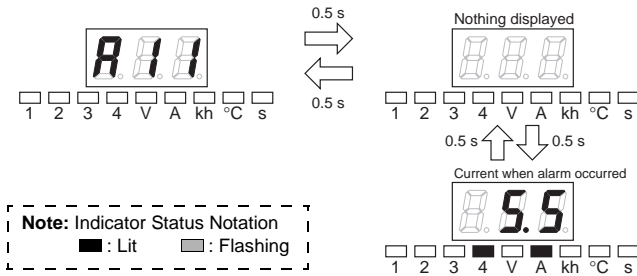

Note: Alarms will be displayed in order of priority if more than one alarm occurs at the same time.
 Order of priority: A10, A11, A20, A21, A22, A23, A30.

Resetting Alarms

When an alarm is displayed, remove the cause of the alarm and then press the Reset Key (RST) for at least 3 s. The following display will appear and the alarm will be reset.

Note: The over-temperature output will automatically be reset when the temperature drops below the set value. All other alarms must be reset manually.

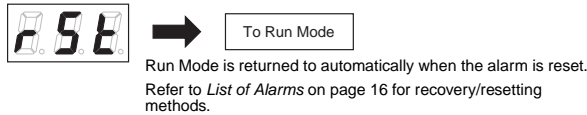

Communications (S8M-CP04-R/ CP04-RS)

The built-in RS-232C port can be used to connect special Support Tool to set parameters, monitor, perform tripping operations for branch outputs, and perform other remote monitoring and control operations from a network.

Type	RS-232C
Communications method	Half-duplex
Sync method	Start-stop
Baud rate	4,800 or 9,600 bps
Transmitted code	ASCII
Data bit length	7 or 8 bits
Stop bit length	1 or 2 bits
Error detection	Vertical parity and BCC
Parity check	None, even, or odd
Protocol	CompoWay/F

Support Tool (S8M-CP04-R/ CP04-RS)

The Support Tool is used to set and monitor models that support communications. Parameters can be set, operation can be monitored, and parameter files can be managed.

Support Tool Functions

- Reading and writing parameter settings
- Monitoring present values
- Monitoring status (cutoff status, normal/error status)

Applicable OS: Windows 2000 or XP

Visit OMRON's website for downloading the Support Tool.

Dimensions

Note: All units are in millimeters unless otherwise indicated.

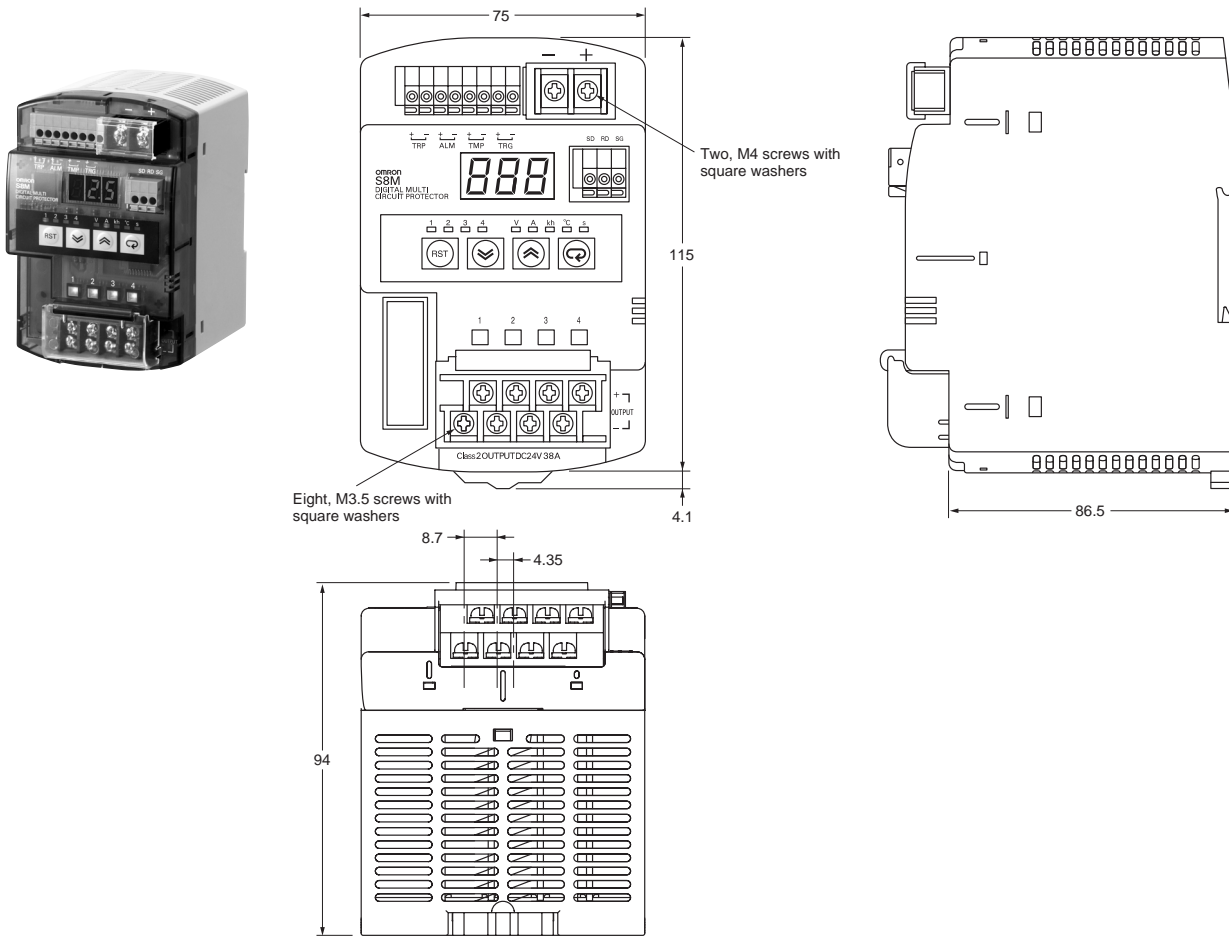

Note: The image is the S8M-CP04-RS Model.

■ DIN Rail (Order Separately)

Note: All units are in millimeters unless otherwise indicated.

Mounting Rail (Material: Aluminum)

PFP-100N

PFP-50N

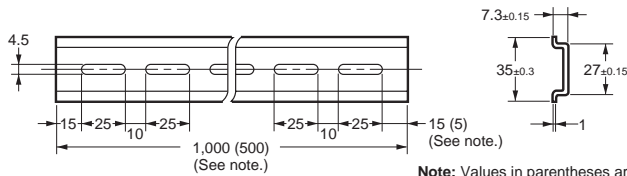
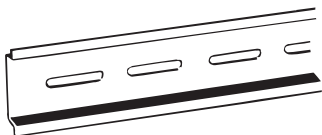

Note: Values in parentheses are for the PFP-50N.

Mounting Rail (Material: Aluminum)

PFP-100N2

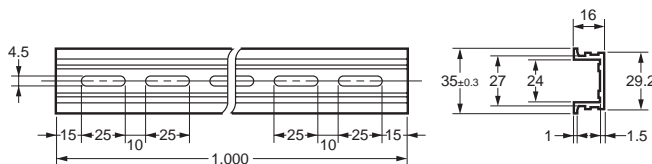
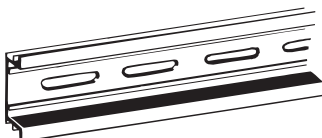

End Plate

PFP-M

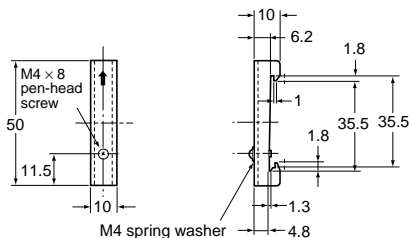
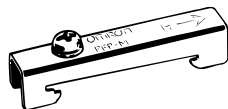

Safety Precautions

CAUTION

Minor electric shock, fire, or Product failure may occasionally occur. Do not disassemble, modify, or repair the Product or touch interior of the Product.



Minor burns may occasionally occur. Do not touch the Product while power is being supplied or immediately after power is turned OFF.



Fire may occasionally occur. Tighten terminal screws to the specified torque.



Power input terminals: M4 1.08 N-m (9.6 in. lb.)

Branch output terminals: M3.5 0.8 to 1.0 N-m (7.2 to 8.8 in. lb.)

Minor electric shock, fire, or Product failure may occasionally occur. Do not allow any pieces of metal or conductors or any clippings or cuttings resulting from installation work to enter the Product.



The Product will be damaged. Do not incorrectly connect the polarity of power input terminals.



Precautions for Safe Use

Mounting

Take adequate measures to ensure proper heat dissipation to increase the long-term reliability of the S8M. Install the S8M so that the air flow circulates around it, because the S8M is designed to radiate heat by means of natural air flow.

Improper mounting will interfere with heat dissipation and may occasionally result in deterioration or damage of internal parts. Do not use any mounting method other than a standard one.

Side-by-side mounting of two or more S8M is possible. The switch mode power supply connected to inputs and any other sources of heat, however, must be separated as shown below.

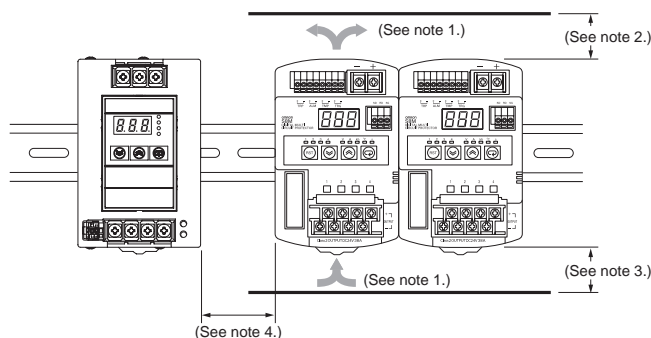

- Note:**
1. Convection of air
 2. 75 mm min.
 3. 75 mm min.
 4. 10 mm min.

Wiring

Minor electric shock during operation may occasionally occur. Always attach the terminal cover when using the S8M.

Minor fire may possibly occur. Ensure that input and output terminals are wired correctly.

Increases in the temperature of internal parts resulting from heating of wiring materials may result in deterioration or damage to internal parts. Use wiring materials suitable to the current being used. The following wiring materials, torque and strip length are recommended to prevent heating and possible fires in wiring materials.

Recommended Wire Types

Terminals	Wiring materials	Torque	Strip length	
Power input terminals	AWG14 (2.081 mm ²) × 2	Solid, Stranded	1.08 N-m (9.6 in. lb.)	8 to 10 mm
Branch output terminals	AWG16 to 20 (1.309 to 0.517 mm ²)		0.8 to 1.0 N-m (7.2 to 8.8 in. lb.)	6 to 7 mm
Other terminals	AWG18 to 26 (0.823 to 0.129 mm ²)	---	---	10 mm

Do not apply more than 100 N force to the terminal block when tightening screws.

Be sure to remove the sheet covering the S8M for machining before power-ON so that it does not interfere with heat dissipation.

Installation Environment

Do not use the S8M in locations subject to shocks or vibrations. In particular, install the S8M as far away as possible from contactors or other devices that are vibration sources. Additionally, install a PFP-M End Plate on each end of the S8M.

Install the S8M well away from any sources of strong, high frequency noise and surge.

Operating Life

The life of the S8M is determined by the life of the electrolytic capacitors used inside. Here, Arrhenius Law applies, i.e., the life will be halved for each rise of 10°C or the life will be doubled for each drop of 10°C. The life of the S8M can thus be increased by reducing its internal temperature.

Ambient Operating and Storage Environment

Store the S8M at a temperature of -25 to 65°C and a humidity of 25% to 90%.

Internal parts may occasionally be deteriorated or damaged. Do not use the S8M in areas outside the derating curve (i.e., in the area shown by shading () in the derating curve diagram on page 6).

Surrounding air temperature for UL 508 Listing and UL60950-1 Recognition is 50°C.

Use the S8M at a humidity of 25% to 85%.

Do not use the S8M in locations subject to direct sunlight.

Do not use the S8M in locations where liquid, foreign matter, or corrosive gases may enter the S8M.

Input Voltage

Input voltage range: 19.2 to 26.4 VDC

The S8M provides abnormal voltage protection. All branch outputs will be cut off if the input voltage exceeds 28.8 VDC. This function, however, does not protect loads and internal parts from high voltages in all cases. Be sure the input voltage is within the rated range.

Outputs may be cut off by the abnormal voltage protection with loads that generate reverse peak electromotive force.

The S8M operates by DC input. Do not connect AC input to power input terminals.

Input Power Supply Selection

The overcurrent protection characteristics of the power supply connected to the input side can cause a voltage drop, resulting in tripping.

If the capacity of the input power supply is too small compared with the load, the overcurrent protection characteristics of the power supply can cause the failure of S8M operating or tripping by voltage drop occasionally.

If the input power supply starts or stops too slowly, the overcurrent protection characteristics of the power supply can cause the failure of S8M operating or tripping by voltage drop occasionally.

Tripping Performance

When abnormal tripping operates, always remove the cause of the output first and then reset the alarm.

When using a load with a fixed power operation, the S8M may cause tripping when the power supply is turned OFF.

Internal parts may possibly be deteriorated or damaged. Do not repeatedly perform tripping or recovery operations more than necessary.

Tripping performance depends on the ambient operating temperature. Use the S8M within the derating curve shown in the derating curve diagram on page 6.

Dielectric Strength Test

The S8M is designed to withstand 500 VAC for 1 minute between I/O terminals, all output signal terminals, the external tripping input terminals, and all communications terminals of the S8M.

The S8M may possibly be damaged from the impulse voltage if a testing device switch is used to abruptly apply or shut off 500 VAC. Increase the applied voltage gradually using the voltage adjustment on the testing device.

Always short the specified terminals so that the voltage is applied to all of the terminals at the same time.

Power input terminals and branch output terminals are not isolated. Do not perform dielectric strength tests or other insulation appraisal testing between inputs and outputs.

External Tripping Input

When using the external tripping input, always confirm the application methods described in the *S8M User's Manual* (Cat. No. Z241) before designing the system.

Display

The voltage detection function monitors the voltage at the power input terminals. Measure the voltage at the branch output terminals to confirm that the output voltage is correct.

Backup Device Connections

Observe the following precautions when using a backup device, such as one from OMRON's S8T Series.

- When connecting a backup device to an S8M branch output, the backup current will be supplied to other branches through internal circuits and it is conceivable that internal parts may be deteriorated or damaged at the same time. When using a backup device with the S8M, connect the backup device to the power input side.
- When connecting a backup device to the S8M input side, the backup time will be shorter than normal due to internal power consumption. Always confirm the backup time when using a backup device.

Startup Delay

The startup delay will not operate when a relay or other device is used for ON/OFF control on the output side of the S8M, so a tripping operation may occasionally occur.

Connections

It is possible to connect S8M like below.

Correct

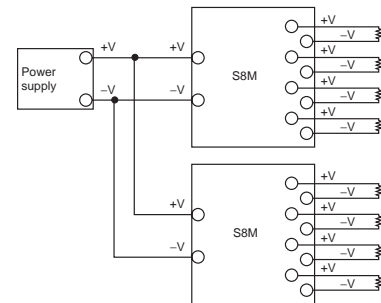

Series connections, such as connecting an S8M to the output of another S8M, are not possible.

Incorrect

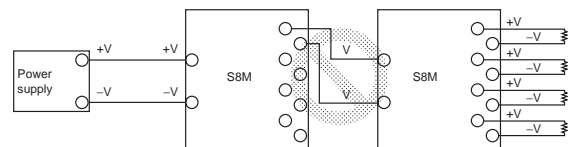

Troubleshooting

If the S8M is not operating properly, check the items listed in the following table before requesting repairs.

Stage	Observed problem	Possible cause	Remedy
Installation	The S8M was installed on a DIN Rail, but the bottom of the Unit is not attached.	The S8M's bottom latch is not mounted properly.	Check that the S8M has been pressed until the bottom latch clicks.
Parameter setting	The desired alarm value is not being displayed.	The setting is not allowed in the present protection level.	Change the protection level setting.
	The set value was changed, but the change wasn't accepted.	The new setting was not saved.	After pressing the Up and Down Keys to change the set value, press the Mode Key and verify that the setting flashes and the setting is saved.
	When the S8M was switched to Run Mode after setting the overvoltage alarm and undervoltage alarm, the alarm output went OFF and cannot be cleared.	The undervoltage and overvoltage settings may have been reversed.	Switch to Setting Mode and check the settings.
Equipment setup	The display is flashing "ON" in Test Mode, but power is not being supplied by the outputs.	A flashing "ON" display indicates that the S8M is waiting to turn ON the outputs.	If the Mode Key is pressed, the output will be connected and power will be supplied. When power is being supplied, "OFF" will flash on the display.
	The S8M was turned OFF in Test Mode, and there was no power from the outputs when the S8M was turned ON again.	If the power is turned OFF in Test Mode, all of the branch outputs are cut off for safety reasons.	Either connect all branch outputs in Test Mode or connect each branch output individually.
	When the output is connected in Test Mode, it is cut off immediately and can't be connected again.	Check whether the status indicator is lit red. The current may be higher than the tripping current.	Check for problems such as output wiring problems. If no problems are found, press the Reset Key for at least 3 s.
Operation	The displayed temperature is clearly different from the ambient temperature.	The S8M detects the Unit's internal temperature, which can be 5 to 10°C higher than the ambient temperature.	When the alarm is being used as a control signal for a fan or cooling equipment, set the alarm value based on the graph in the <i>S8M User's Manual</i> (Cat. No. Z241).
	An alarm was output and the cause of the alarm was eliminated, but the alarm display cannot be cleared.	The S8M doesn't disregard temporary errors, so the alarm display is retained even after the cause of the alarm is cleared.	The alarm can be cleared by pressing the Reset Key for at least 3 s.
	The peak output current value is not displayed and the display shows "- -".	The current may have exceeded the measurable range.	Clear the peak output current value in Run Mode.
	The circuit was not designed for a current that high, but the circuit is cut off as soon as power is supplied.	The abnormal current tripping type (detection method) may be set to "instantaneous." With instantaneous detection, an abnormal current is detected very quickly and the circuit may be cut off due to excessive current during equipment operation.	Either change the abnormal current tripping type from instantaneous to standard or raise the current tripping value.
		There may be a large number of devices connected to the output. The more devices that are connected, the higher the operating current.	Use the S8M's startup sequence function to spread out the connections to the devices (delay the connection of some devices).
Branch output cut off	The connection cannot be reset immediately after it is cut off.	To protect the S8M's internal circuits, at least 15 seconds must pass before a cut-off output can be reset.	If "RST" is displayed when the Reset Key is pressed for at least 3 s, the cut-off output can be reset when 15 s has passed since the output was cut off.
	The output was reset, but it was immediately cut off again.	The original cause of tripping may not have been eliminated. After resetting the error, a large current may have flowed again.	Eliminate the cause of the cutoff and press the Reset Key for at least 3 s.
Maintenance	The run time alarm went OFF, so the equipment was checked and other parts were replaced, but the alarm could not be cleared.	The S8M continues adding to the run time. The run time must be reset to 0 in order to clear the alarm.	Clear the run time.

Warranty and Application Considerations

Read and Understand this Catalog

Please read and understand this catalog before purchasing the products. Please consult your OMRON representative if you have any questions or comments.

Warranty and Limitations of Liability

WARRANTY

OMRON's exclusive warranty is that the products are free from defects in materials and workmanship for a period of one year (or other period if specified) from date of sale by OMRON.

OMRON MAKES NO WARRANTY OR REPRESENTATION, EXPRESS OR IMPLIED, REGARDING NON-INFRINGEMENT, MERCHANTABILITY, OR FITNESS FOR PARTICULAR PURPOSE OF THE PRODUCTS. ANY BUYER OR USER ACKNOWLEDGES THAT THE BUYER OR USER ALONE HAS DETERMINED THAT THE PRODUCTS WILL SUITABLY MEET THE REQUIREMENTS OF THEIR INTENDED USE. OMRON DISCLAIMS ALL OTHER WARRANTIES, EXPRESS OR IMPLIED.

LIMITATIONS OF LIABILITY

OMRON SHALL NOT BE RESPONSIBLE FOR SPECIAL, INDIRECT, OR CONSEQUENTIAL DAMAGES, LOSS OF PROFITS, OR COMMERCIAL LOSS IN ANY WAY CONNECTED WITH THE PRODUCTS, WHETHER SUCH CLAIM IS BASED ON CONTRACT, WARRANTY, NEGLIGENCE, OR STRICT LIABILITY.

In no event shall the responsibility of OMRON for any act exceed the individual price of the product on which liability is asserted.

IN NO EVENT SHALL OMRON BE RESPONSIBLE FOR WARRANTY, REPAIR, OR OTHER CLAIMS REGARDING THE PRODUCTS UNLESS OMRON'S ANALYSIS CONFIRMS THAT THE PRODUCTS WERE PROPERLY HANDLED, STORED, INSTALLED, AND MAINTAINED AND NOT SUBJECT TO CONTAMINATION, ABUSE, MISUSE, OR INAPPROPRIATE MODIFICATION OR REPAIR.

Application Considerations

SUITABILITY FOR USE

OMRON shall not be responsible for conformity with any standards, codes, or regulations that apply to the combination of products in the customer's application or use of the products.

Take all necessary steps to determine the suitability of the product for the systems, machines, and equipment with which it will be used.

Know and observe all prohibitions of use applicable to this product.

NEVER USE THE PRODUCTS FOR AN APPLICATION INVOLVING SERIOUS RISK TO LIFE OR PROPERTY WITHOUT ENSURING THAT THE SYSTEM AS A WHOLE HAS BEEN DESIGNED TO ADDRESS THE RISKS, AND THAT THE OMRON PRODUCTS ARE PROPERLY RATED AND INSTALLED FOR THE INTENDED USE WITHIN THE OVERALL EQUIPMENT OR SYSTEM.

Disclaimers

PERFORMANCE DATA

Performance data given in this catalog is provided as a guide for the user in determining suitability and does not constitute a warranty. It may represent the result of OMRON's test conditions, and the users must correlate it to actual application requirements. Actual performance is subject to the OMRON *Warranty and Limitations of Liability*.

CHANGE IN SPECIFICATIONS

Product specifications and accessories may be changed at any time based on improvements and other reasons. Consult with your OMRON representative at any time to confirm actual specifications of purchased product.

DIMENSIONS AND WEIGHTS

Dimensions and weights are nominal and are not to be used for manufacturing purposes, even when tolerances are shown.

ALL DIMENSIONS SHOWN ARE IN MILLIMETERS.

To convert millimeters into inches, multiply by 0.03937. To convert grams into ounces, multiply by 0.03527.

Cat. No. T037-E1-01 **In the interest of product improvement, specifications are subject to change without notice.**

OMRON Corporation

Industrial Automation Company

Control Devices Division H.Q.

Power Electronics Department

Shiokoji Horikawa, Shimogyo-ku,

Kyoto, 600-8530 Japan

Tel: (81)75-344-7108/Fax: (81)75-344-7189

Printed in Japan

0506-1.5M (0506) (C)