

Σ -7-Series AC Servo Drive Rotary Servomotor Product Manual

Model: SGM7M/SGM7J/SGM7A/SGM7P/SGM7G/SGMMV

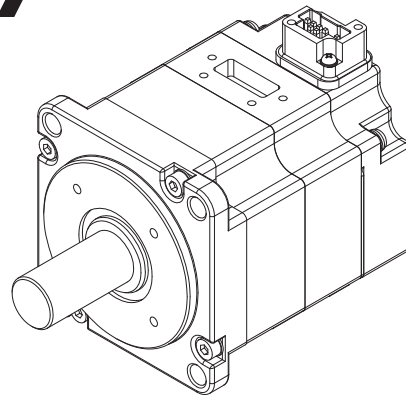

Basic Information on Servomotors	1
Capacity Selection	2
Specifications, Ratings, and External Dimensions of SGM7M Servomotors	3
Specifications, Ratings, and External Dimensions of SGM7J Servomotors	4
Specifications, Ratings, and External Dimensions of SGM7A Servomotors	5
Specifications, Ratings, and External Dimensions of SGM7P Servomotors	6
Specifications, Ratings, and External Dimensions of SGM7G Servomotors	7
Specifications, Ratings, and External Dimensions of SGMMV Servomotors	8
Servomotor Installation	9
Connections between Servomotors and SERVOPACKs	10
Maintenance and Inspection	11
Appendices	12

Copyright © 2014 YASKAWA ELECTRIC CORPORATION

All rights reserved. No part of this publication may be reproduced, stored in a retrieval system, or transmitted, in any form, or by any means, mechanical, electronic, photocopying, recording, or otherwise, without the prior written permission of Yaskawa. No patent liability is assumed with respect to the use of the information contained herein. Moreover, because Yaskawa is constantly striving to improve its high-quality products, the information contained in this manual is subject to change without notice. Every precaution has been taken in the preparation of this manual. Nevertheless, Yaskawa assumes no responsibility for errors or omissions. Neither is any liability assumed for damages resulting from the use of the information contained in this publication.

About this Manual

This manual provides information required to select, install, connect, and maintain Rotary Servomotors for Σ -7-Series AC Servo Drives.

Read and understand this manual to ensure correct usage of the Σ -7-Series AC Servo Drives.

Keep this manual in a safe place so that it can be referred to whenever necessary.

Outline of Manual

The contents of the chapters of this manual are described in the following table.

Refer to these chapters as required.

Chapter	Chapter Title	Contents
1	Basic Information on Servomotors	Provides basic information on Rotary Servomotors, including Servomotor part names and combinations with SERVOPACKs.
2	Capacity Selection	Describes calculation methods to use when selecting Servomotor capacities.
3	Specifications, Ratings, and External Dimensions of SGM7M Servomotors	Describes how to interpret the model numbers of SGM7M Servomotors and gives their specifications, ratings, and external dimensions.
4	Specifications, Ratings, and External Dimensions of SGM7J Servomotors	Describes how to interpret the model numbers of SGM7J Servomotors and gives their specifications, ratings, and external dimensions.
5	Specifications, Ratings, and External Dimensions of SGM7A Servomotors	Describes how to interpret the model numbers of SGM7A Servomotors and gives their specifications, ratings, and external dimensions.
6	Specifications, Ratings, and External Dimensions of SGM7P Servomotors	Describes how to interpret the model numbers of SGM7P Servomotors and gives their specifications, ratings, and external dimensions.
7	Specifications, Ratings, and External Dimensions of SGM7G Servomotors	Describes how to interpret the model numbers of SGM7G Servomotors and gives their specifications, ratings, and external dimensions.
8	Specifications, Ratings, and External Dimensions of SGMMV Servomotors	Describes how to interpret the model numbers of SGMMV Servomotors and gives their specifications, ratings, and external dimensions.
9	Servomotor Installation	Describes the installation conditions, procedures, and precautions for Servomotors.
10	Connections between Servomotors and SERVOPACKs	Describes the cables that are used to connect the Servomotors and SERVOPACKs and provides related precautions.
11	Maintenance and Inspection	Describes the maintenance, inspection, and disposal of a Servomotor.
12	Appendices	Provide additional information on Servomotors with Gears and reference information on selecting Servomotor capacity.

Related Documents

The relationships between the documents that are related to the Servo Drives are shown in the following figure. The numbers in the figure correspond to the numbers in the table on the following pages. Refer to these documents as required.

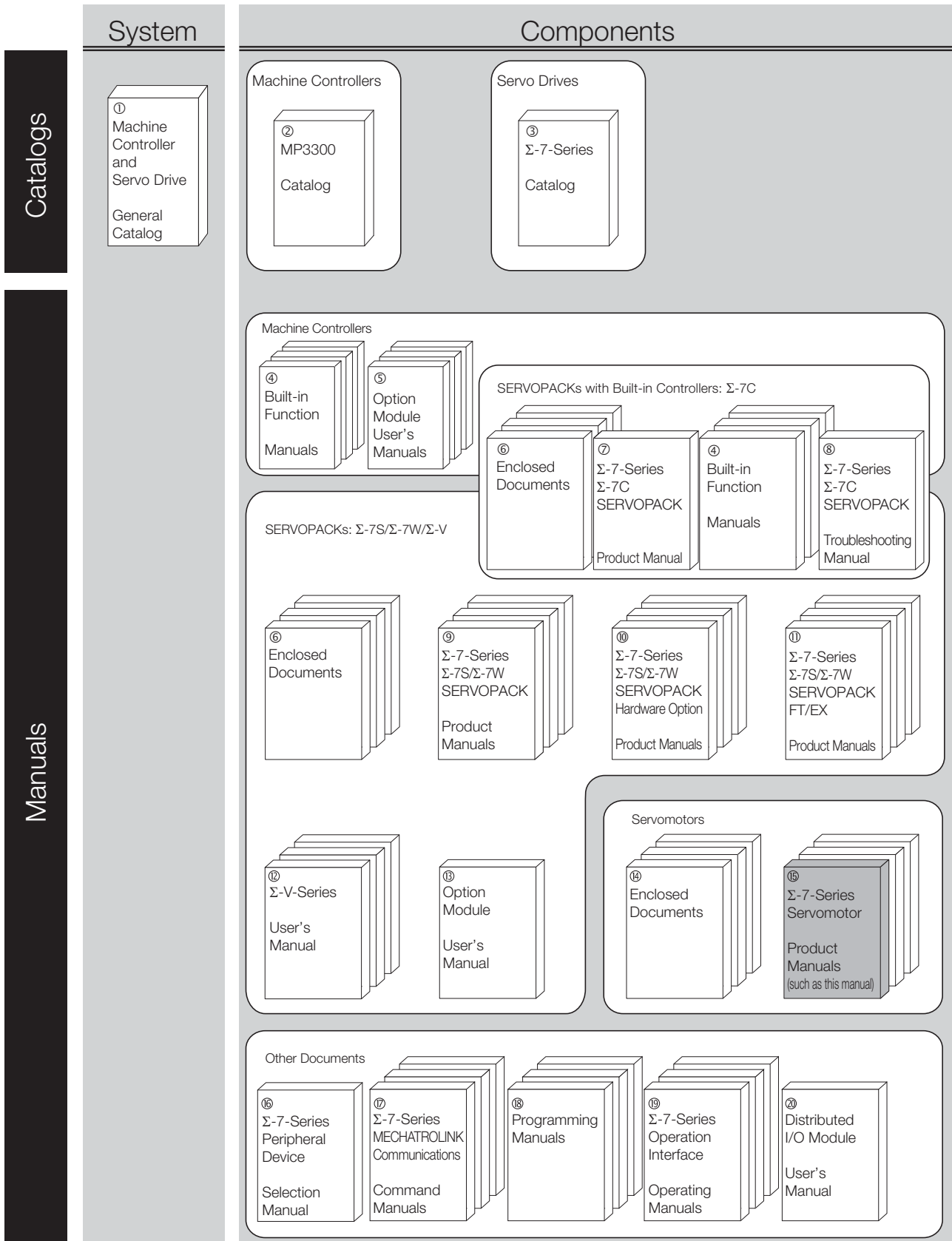

Classification	Document Name	Document No.	Description
① Machine Controller and Servo Drive General Catalog	Machine Controller and AC Servo Drive Solutions Catalog	KAEP S800001 22	Describes the features and application examples for combinations of MP3000-Series Machine Controllers and Σ -7-Series AC Servo Drives.
② MP3300 Catalog	Machine Controller MP3300	KAEP C880725 03	Provides detailed information on MP3300 Machine Controllers, including features and specifications.
③ Σ -7-Series Catalog	AC Servo Drives Σ -7 Series	KAEP S800001 23	Provides detailed information on Σ -7-Series AC Servo Drives, including features and specifications.
④ Built-in Function Manuals	Σ -7-Series AC Servo Drive Σ -7C SERVOPACK Motion Control User's Manual	SIEP S800002 03	Provides detailed information on the specifications, system configuration, and application methods of the Motion Control Function Modules (SVD, SVC4, and SVR4) for Σ -7-Series Σ -7C SERVOPACKs.
	Machine Controller MP3000 Series Communications User's Manual	SIEP C880725 12	Provides detailed information on the specifications, system configuration, and communications connection methods for the Ethernet communications that are used with MP3000-Series Machine Controllers and Σ -7-Series Σ -7C SERVOPACKs.
⑤ Option Module User's Manuals	Machine Controller MP2000 Series Communication Module User's Manual	SIEP C880700 04	Provide detailed information on the specifications and communications methods for the Communications Modules that can be mounted to MP3000-Series Machine Controllers and Σ -7-Series Σ -7C SERVOPACKs.
	Machine Controller MP2000 Series 262IF-01 FL-net Communication Module User's Manual	SIEP C880700 36	
	Machine Controller MP2000 Series 263IF-01 EtherNet/IP Communication Module User's Manual	SIEP C880700 39	
	Machine Controller MP2000 Series I/O Module User's Manual	SIEP C880700 34	Provide detailed information on the specifications and communications methods for the I/O Modules that can be mounted to MP3000-Series Machine Controllers and Σ -7-Series Σ -7C SERVOPACKs.
	Machine Controller MP2000 Series Analog Input/Analog Output Module AI-01/AO-01 User's Manual	SIEP C880700 26	
	Machine Controller MP2000 Series Counter Module CNTR-01 User's Manual	SIEP C880700 27	

Continued on next page.

Continued from previous page.

Classification	Document Name	Document No.	Description
⑥ Enclosed Documents	Σ-7-Series AC Servo Drive Σ-7S and Σ-7W SERVOPACK Safety Precautions	TOMP C710828 00	Provides detailed information for the safe usage of Σ-7-Series SERVOPACKs.
	AC SERVOPACK Σ-V Series Safety Precautions	TOMP C710800 10	Provide detailed information for the safe usage of Σ-V-Series SERVO-PACKs.
	Σ-V-Series AC SERVOPACK SGDV Safety Precautions Supplement	TOBP C710829 02	
	AC SERVOPACK Σ-V-MD-Series Safety Precautions Type A01	TOBP C710829 14	Provide detailed information for the safe usage of Σ-V-MD-Series SERVOPACKs.
	AC SERVOPACK Σ-V-MD-Series Safety Precautions Type A02	TOBP C710829 10	
	DC Power Input Σ-V Series AC SERVOPACK Safety Precautions	TOBP C710829 06	Provides detailed information for the safe usage of DC Power Input Σ-V Series SERVOPACKs.
	Σ-V-Series/Σ-V-Series for Large-Capacity Models/ Σ-7-Series Safety Precautions Option Module	TOBP C720829 00	Provides detailed information for the safe usage of Option Modules.
	Σ-V-Series/Σ-V-Series for Large-Capacity Models/ Σ-7-Series Installation Guide Command Option Module	TOBP C720829 01	Provides detailed procedures for installing the Command Option Module in a SERVOPACK.
	Σ-V-Series/Σ-V-Series for Large-Capacity Models/ Σ-7-Series Installation Guide Fully-closed Module	TOBP C720829 03	Provides detailed procedures for installing the Fully-closed Module in a SERVOPACK.
	Σ-V-Series/Σ-V-Series for Large-Capacity Models/ Σ-7-Series Installation Guide Safety Module	TOBP C720829 06	Provides detailed procedures for installing the Safety Module in a SERVOPACK.
	Σ-V-Series/Σ-V-Series for Large-Capacity Models/ Σ-7-Series Installation Guide INDEXER Module	TOBP C720829 02	Provides detailed procedures for installing the INDEXER Module in a SERVOPACK.
	Σ-V-Series/Σ-V-Series for Large-Capacity Models/ Σ-7-Series Installation Guide DeviceNet Module	TOBP C720829 07	Provides detailed procedures for installing the DeviceNet Module in a SERVOPACK.
⑦ Σ-7-Series Σ-7C SERVOPACK Product Manual	Σ-7-Series AC Servo Drive Σ-7C SERVOPACK Product Manual	SIEP S800002 04	Provides detailed information on selecting Σ-7-Series Σ-7C SERVO-PACKs; installing, connecting, setting, testing in trial operation, and tuning Servo Drives; writing, monitoring, and maintaining programs; and other information.
⑧ Σ-7-Series Σ-7C SERVOPACK Troubleshooting Manual	Σ-7-Series AC Servo Drive Σ-7C SERVOPACK Troubleshooting Manual	SIEP S800002 07	Provides detailed troubleshooting information for Σ-7-Series Σ-7C SERVOPACKs.

Continued on next page.

Continued from previous page.

Classification	Document Name	Document No.	Description
⑨ Σ-7-Series Σ-7S/Σ-7W SERVOPACK Product Manuals	Σ-7-Series AC Servo Drive Σ-7S SERVOPACK with MECHATROLINK-III Communications References Product Manual	SIEP S800001 28	Provide detailed information on selecting Σ-7-Series SERVO-PACKs and information on installing, connecting, setting, performing trial operation for, tuning, monitoring, and maintaining the Servo Drives.
	Σ-7-Series AC Servo Drive Σ-7S SERVOPACK with MECHATROLINK-II Communications References Product Manual	SIEP S800001 27	
	Σ-7-Series AC Servo Drive Σ-7S SERVOPACK with Analog Voltage/Pulse Train References Product Manual	SIEP S800001 26	
	Σ-7-Series AC Servo Drive Σ-7S SERVOPACK Command Option Attachable Type with INDEXER Module Product Manual	SIEP S800001 64	
	Σ-7-Series AC Servo Drive Σ-7S SERVOPACK Command Option Attachable Type with DeviceNet Module Product Manual	SIEP S800001 70	
	Σ-7-Series AC Servo Drive Σ-7W SERVOPACK with MECHATROLINK-III Communications References Product Manual	SIEP S800001 29	
⑩ Σ-7-Series Σ-7S/Σ-7W SERVOPACK with Hardware Option Specifications Product Manuals	Σ-7-Series AC Servo Drive Σ-7S/Σ-7W SERVOPACK with Hardware Option Specifica- tions Dynamic Brake Product Manual	SIEP S800001 73	Provide detailed information on Hardware Options for Σ-7-Series SERVOPACKs.
	Σ-7-Series AC Servo Drive Σ-7W/Σ-7C SERVOPACK with Hardware Option Specifica- tions HWBB Function Product Manual	SIEP S800001 72	

Continued on next page.

Continued from previous page.

Classification	Document Name	Document No.	Description
⑩ Σ-7-Series Σ-7S/Σ-7W SERVOPACK FT/EX Product Manuals	Σ-7-Series AC Servo Drive Σ-7S SERVOPACK with FT/EX Specification for Index- ing Application Product Manual	SIEP S800001 84	Provide detailed information on the FT/EX Option for Σ-7-Series SERVOPACKs.
	Σ-7-Series AC Servo Drive Σ-7S SERVOPACK with FT/EX Specification for Track- ing Application Product Manual	SIEP S800001 89	
	Σ-7-Series AC Servo Drive Σ-7S SERVOPACK with FT/EX Specification for Application with Special Motor, SGM7D Motor Product Manual	SIEP S800001 91	
	Σ-7-Series AC Servo Drive Σ-7S SERVOPACK with FT/EX Specification for Press and Injection Molding Application Product Manual	SIEP S800001 94	
	Σ-7-Series AC Servo Drive Σ-7S SERVOPACK with FT/EX Specification for Transfer and Alignment Application Product Manual	SIEP S800001 95	
	Σ-7-Series AC Servo Drive Σ-7S SERVOPACK with FT/EX Specification for Torque/Force Assistance for Conveyance Application Product Manual	SIEP S800002 09	
	Σ-7-Series AC Servo Drive Σ-7S SERVOPACK with FT/EX Specification for Cutting Application Feed Shaft Motor Product Manual	SIEP S800002 10	

Continued on next page.

Continued from previous page.

Classification	Document Name	Document No.	Description
⑩ Σ-V-Series User's Manual	AC Servo Drives DC Power Input Σ-V Series User's Manual Setup Rotational Motor	SIEP S800000 80	Provide details information required for the design and maintenance of the DC Power Input Σ-V Series SERVOPACKS.
	AC Servo Drives DC Power Input Σ-V Series User's Manual Design and Maintenance Rotational Motor Analog Voltage Reference and Pulse Train Reference	SIEP S800000 81	
	AC Servo Drives DC Power Input Σ-V Series User's Manual Design and Maintenance Rotational Motor MECHATROLINK-II Communications Reference	SIEP S800000 82	
	AC Servo Drives DC Power Input Σ-V Series User's Manual Design and Maintenance Rotational Motor MECHATROLINK-III Communications Reference	SIEP S800000 83	
	AC Servo Drives Σ-V-MD Series User's Manual Type A01/A02 Rotational Motor MECHATROLINK-III Communications References	SIEP S800001 02	
⑩ Option Module User's Manual	AC Servo Drives Σ-V Series/Σ-V Series for Large-Capacity Models/ Σ-7 Series User's Manual Safety Module	SIEP C720829 06	Provides details information required for the design and maintenance of a Safety Module.
⑩ Enclosed Documents	AC Servo Drive Rotary Servomotor Safety Precautions	TOBP C230260 00	Provides detailed information for the safe usage of Rotary Servomotors and Direct Drive Servomotors.
	AC Servomotor Linear Σ Series Safety Precautions	TOBP C230800 00	Provides detailed information for the safe usage of Linear Servomotors.
⑩ Σ-7-Series Servomotor Product Manuals	Σ-7-Series AC Servo Drive Rotary Servomotor Product Manual	This manual (SIEP S800001 36)	Provide detailed information on selecting, installing, and connecting the Σ-7-Series Servomotors.
	Σ-7-Series AC Servo Drive Linear Servomotor Product Manual	SIEP S800001 37	
	Σ-7-Series AC Servo Drive Direct Drive Servomotor Product Manual	SIEP S800001 38	

Continued on next page.

Continued from previous page.

Classification	Document Name	Document No.	Description
⑯ Σ-7-Series Peripheral Device Selection Manual	Σ-7-Series AC Servo Drive Peripheral Device Selection Manual	SIEP S800001 32	Provides the following information in detail for Σ-7-Series Servo Sys- tems. • Cables: Models, dimensions, wir- ing materials, connector models, and connection specifications • Peripheral devices: Models, specifications, diagrams, and selection (calculation) methods
⑰ Σ-7-Series MECHATROLINK Communications Command Manuals	Σ-7-Series AC Servo Drive MECHATROLINK-II Communications Command Manual	SIEP S800001 30	Provides detailed information on the MECHATROLINK-II communi- cations commands that are used for a Σ-7-Series Servo System.
	Σ-7-Series AC Servo Drive MECHATROLINK-III Communications Standard Servo Profile Command Manual	SIEP S800001 31	Provides detailed information on the MECHATROLINK-III communi- cations standard servo profile com- mands that are used for a Σ-7- Series Servo System.
⑱ Programming Manuals	Machine Controller MP3000 Series Ladder Programming Manual	SIEP C880725 13	Provides detailed information on the ladder programming specifica- tions and instructions for MP3000- Series Machine Controllers and Σ- 7-Series Σ-7C SERVOPACKs.
	Machine Controller MP3000 Series Motion Programming Manual	SIEP C880725 14	Provides detailed information on the motion programming and sequence programming specifica- tions and instructions for MP3000- Series Machine Controllers and Σ- 7-Series Σ-7C SERVOPACKs.
⑲ Σ-7-Series Operation Interface Operating Manuals	Machine Controller MP2000/MP3000 Series Engineering Tool MPE720 Version 7 User's Manual	SIEP C880761 03	Describes in detail how to operate MPE720 version 7.
	Σ-7-Series AC Servo Drive Digital Operator Operating Manual	SIEP S800001 33	Describes the operating proce- dures for a Digital Operator for a Σ-7-Series Servo System.
	AC Servo Drive Engineering Tool SigmaWin+ Operation Manual	SIET S800001 34	Provides detailed operating proce- dures for the SigmaWin+ Engineer- ing Tool for a Σ-7-Series Servo System.
⑳ Distributed I/O Module User's Manuals	MECHATROLINK-III Compatible I/O Module User's Manual	SIEP C880781 04	Describes the functions, specifica- tions, operating methods, and MECHATROLINK-III communi- cations for the Remote I/O Modules for MP2000/MP3000-Series Machine Controllers.

Using This Manual

◆ Technical Terms Used in This Manual

The following terms are used in this manual.

Term	Meaning
Servomotor	A Σ -7-Series Rotary Servomotor.
SERVOPACK	A Σ -7-Series Σ -7S Servo Amplifier.
Servo Drive	The combination of a Servomotor and SERVOPACK.
Main Circuit Cable	One of the cables that connect to the main circuit terminals, including the Main Circuit Power Supply Cable, Control Power Supply Cable, and Servomotor Main Circuit Cable.
absolute encoder	The general term used for absolute encoders with batteries and batteryless absolute encoders. In cases where the general term causes confusion, the term “batteryless absolute encoder” may also be used.

◆ Trademarks

- MECHATROLINK is a trademark of the MECHATROLINK Members Association.
- QR code is a trademark of Denso Wave Inc.
- Other product names and company names are the trademarks or registered trademarks of the respective company. “TM” and the ® mark do not appear with product or company names in this manual.

◆ Visual Aids

The following aids are used to indicate certain types of information for easier reference.



Important

Indicates precautions or restrictions that must be observed.
Also indicates alarm displays and other precautions that will not result in machine damage.



Term

Indicates definitions of difficult terms or terms that have not been previously explained in this manual.

Example Indicates operating or setting examples.

Information Indicates supplemental information to deepen understanding or useful information.

Safety Precautions

◆ Safety Information

To prevent personal injury and equipment damage in advance, the following signal words are used to indicate safety precautions in this document. The signal words are used to classify the hazards and the degree of damage or injury that may occur if a product is used incorrectly. Information marked as shown below is important for safety. Always read this information and heed the precautions that are provided.

DANGER

- Indicates precautions that, if not heeded, are likely to result in loss of life, serious injury, or fire.

WARNING

- Indicates precautions that, if not heeded, could result in loss of life, serious injury, or fire.

CAUTION

- Indicates precautions that, if not heeded, could result in relatively serious or minor injury, or in fire.

NOTICE

- Indicates precautions that, if not heeded, could result in property damage.

◆ Safety Precautions That Must Always Be Observed

■ General Precautions



DANGER

- Read and understand this manual to ensure the safe usage of the product.
- Keep this manual in a safe, convenient place so that it can be referred to whenever necessary. Make sure that it is delivered to the final user of the product.
- Do not remove covers, cables, connectors, or optional devices while power is being supplied to the SERVOPACK.
There is a risk of electric shock, operational failure of the product, or burning.



WARNING

- Connect the ground terminals on the SERVOPACK and Servomotor to ground poles according to local electrical codes (100 Ω or less for a SERVOPACK with a 100-VAC or 200-VAC power supply, and 10 Ω or less for a SERVOPACK with a 400-VAC power supply).
There is a risk of electric shock or fire.
- Do not attempt to disassemble, repair, or modify the product.
There is a risk of fire or failure.
The warranty is void for the product if you disassemble, repair, or modify it.



CAUTION

- The SERVOPACK heat sinks, regenerative resistors, External Dynamic Brake Resistors, Servomotors, and other components can be very hot while power is ON or soon after the power is turned OFF. Implement safety measures, such as installing covers, so that hands and parts such as cables do not come into contact with hot components.
There is a risk of burn injury.
- Do not damage, pull on, apply excessive force to, place heavy objects on, or pinch cables.
There is a risk of failure, damage, or electric shock.
- Do not use the product in an environment that is subject to water, corrosive gases, or flammable gases, or near flammable materials.
There is a risk of electric shock or fire.

NOTICE

- Do not attempt to use a SERVOPACK or Servomotor that is damaged or that has missing parts.
- Install external emergency stop circuits that shut OFF the power supply and stops operation immediately when an error occurs.
- Select the brake power supply for a Servomotor with a Holding Brake according to the power supply voltage and capacity required for the Servomotor model, as given in manuals and catalogs. Also confirm the input voltage to the holding brake.
- Always install a surge absorber as a protective device between the brake power supply and Servomotor.
There is a risk of damage to the Servomotor.
- The time required for a holding brake to operate depends on the types of protective devices. The time required for a holding brake to operate will also change if holding brakes are connected in parallel. Always check the time required for a holding brake to operate on the actual machine before you operate a Servomotor.
- Always use a Servomotor and SERVOPACK in one of the specified combinations.
- Do not touch a SERVOPACK or Servomotor with wet hands.
There is a risk of product failure.

■ Storage Precautions



CAUTION

- Do not place an excessive load on the product during storage. (Follow all instructions on the packages.)
There is a risk of injury or damage.

NOTICE

- Do not install or store the product in any of the following locations.
 - Locations that are subject to direct sunlight
 - Locations that are subject to ambient temperatures that exceed product specifications
 - Locations that are subject to relative humidities that exceed product specifications
 - Locations that are subject to condensation as the result of extreme changes in temperature
 - Locations that are subject to corrosive or flammable gases
 - Locations that are near flammable materials
 - Locations that are subject to dust, salts, or iron powder
 - Locations that are subject to water, oil, or chemicals
 - Locations that are subject to vibration or shock that exceeds product specifications
 - Locations that are subject to radiationIf you store or install the product in any of the above locations, the product may fail or be damaged.
- Although machined surfaces are covered with an anticorrosive coating, rust can develop due to storage conditions or the length of storage. If you store the product for more than six months, reapply an anticorrosive coating to machined surfaces, particularly the motor shaft.
- Consult with your Yaskawa representative if you have stored products for an extended period of time.

■ Transportation Precautions



CAUTION

- Transport the product in a way that is suitable to the mass of the product.
- Do not hold onto the cables or motor shaft when you move a Servomotor.
There is a risk of disconnection, damage, or injury.
- Do not use the eyebolts on a SERVOPACK or Servomotor to move the machine.
There is a risk of damage or injury.
- When you handle a SERVOPACK or Servomotor, be careful of sharp parts, such as the corners.
There is a risk of injury.
- Do not place an excessive load on the product during transportation. (Follow all instructions on the packages.)
There is a risk of injury or damage.

NOTICE

- **A SERVOPACK or Servomotor is a precision device. Do not drop it or subject it to strong shock.**
There is a risk of failure or damage.
- **Do not subject connectors to shock.**
There is a risk of faulty connections or damage.
- **If disinfectants or insecticides must be used to treat packing materials such as wooden frames, plywood, or pallets, the packing materials must be treated before the product is packaged, and methods other than fumigation must be used.**
Example: Heat treatment, where materials are kiln-dried to a core temperature of 56°C for 30 minutes or more.
If the electronic products, which include stand-alone products and products installed in machines, are packed with fumigated wooden materials, the electrical components may be greatly damaged by the gases or fumes resulting from the fumigation process. In particular, disinfectants containing halogen, which includes chlorine, fluorine, bromine, or iodine can contribute to the erosion of the capacitors.
- **Do not overtighten the eyebolts on a SERVOPACK or Servomotor.**
If you use a tool to overtighten the eyebolts, the tapped holes may be damaged.

■ Installation Precautions

CAUTION

- **Do not touch the key slot with your bare hands on the shaft end on a Servomotor with a Key Slot.**
There is a risk of injury.
- **Securely mount the Servomotor to the machine.**
If the Servomotor is not mounted securely, it may come off the machine during operation.
- **Install the Servomotor or SERVOPACK in a way that will support the mass given in technical documents.**
- **Install SERVOPACKs, Servomotors, regenerative resistors, and External Dynamic Brake Resistors on nonflammable materials.**
Installation directly onto or near flammable materials may result in fire.
- **Do not step on or place a heavy object on the product.**
There is a risk of failure, damage, or injury.
- **Do not allow any foreign matter to enter the SERVOPACK or Servomotor.**
There is a risk of failure or fire.
- **Implement safety measures, such as installing a cover so that the rotating part of the Servomotor cannot be touched accidentally during operation.**

NOTICE

- Do not install or store the product in any of the following locations.
 - Locations that are subject to direct sunlight
 - Locations that are subject to ambient temperatures that exceed product specifications
 - Locations that are subject to relative humidities that exceed product specifications
 - Locations that are subject to condensation as the result of extreme changes in temperature
 - Locations that are subject to corrosive or flammable gases
 - Locations that are near flammable materials
 - Locations that are subject to dust, salts, or iron powder
 - Locations that are subject to water, oil, or chemicals
 - Locations that are subject to vibration or shock that exceeds product specifications
 - Locations that are subject to radiationIf you store or install the product in any of the above locations, the product may fail or be damaged.
- Use the product in an environment that is appropriate for the product specifications.
If you use the product in an environment that exceeds product specifications, the product may fail or be damaged.
- A SERVOPACK or Servomotor is a precision device. Do not drop it or subject it to strong shock.
There is a risk of failure or damage.
- A Servomotor is a precision device. Do not subject the output shaft or the main body of the Servomotor to strong shock.
- Design the machine so that the thrust and radial loads on the motor shaft during operation do not exceed the allowable values given in the catalog.
- When you attach the key to the motor shaft, do not subject the key slot to direct shock.
- Do not allow any foreign matter to enter a SERVOPACK or a Servomotor with a Cooling Fan and do not cover the outlet from the Servomotor's cooling fan.
There is a risk of failure.
- If you use oil as the gear lubricant, always inject the specified oil before starting operation.
- You can install the Servomotor either horizontally or vertically. However, if you install a Servomotor with an Oil Seal with the output shaft facing upward, oil may enter the Servomotor depending on the operating conditions. Confirm the operating conditions sufficiently if you install a Servomotor with the output shaft facing upward. Some Servomotors with Gears have restrictions on the installation orientation. Refer to the relevant technical documents.
- If an installation orientation is specified for a Servomotor with a Gear, install the Servomotor in the specified orientation.
There is a risk of failure due to oil leakage.
- For a Servomotor with an Oil Seal, use the Servomotor with the oil seal in a lubricated condition with only splashing of oil.
If the Servomotor is used with the oil seal under the surface of the oil, oil may enter the Servomotor, possibly resulting in failure.
- The shaft opening of a Servomotor is not waterproof or oilproof. Implement measures in the machine to prevent water or cutting oil from entering the Servomotor.
There is a risk of failure.
- In an application where the Servomotor would be subjected to large quantities of water or oil, implement measures to protect the Servomotor from large quantities of liquid, such as installing covers to protect against water and oil.
- In an environment with high humidity or oil mist, face Servomotor lead wires and connectors downward and provide cable traps.
There is a risk of failure or fire due to insulation failure or accidents from short circuits.

■ Wiring Precautions



DANGER

- Do not change any wiring while power is being supplied.
There is a risk of electric shock or injury.



WARNING

- **Wiring and inspections must be performed only by qualified engineers.**
There is a risk of electric shock or product failure.
- **Check all wiring and power supplies carefully.**
Incorrect wiring or incorrect voltage application to the output circuits may cause short-circuit failures. If a short-circuit failure occurs as a result of any of these causes, the holding brake will not work. This could damage the machine or cause an accident that may result in death or injury.



CAUTION

- **Observe the precautions and instructions for wiring and trial operation precisely as described in this document.**
Failures caused by incorrect wiring or incorrect voltage application in the brake circuit may cause the SERVOPACK to fail, damage the equipment, or cause an accident resulting in death or injury.
- **Check the wiring to be sure it has been performed correctly.**
Connectors and pin layouts are sometimes different for different models. Always confirm the pin layouts in technical documents for your model before operation.
There is a risk of failure or malfunction.
- **Connect wires to power supply terminals and motor connection terminals securely with the specified methods and tightening torque.**
Insufficient tightening may cause wires and terminal blocks to generate heat due to faulty contact, possibly resulting in fire.
- **Use shielded twisted-pair cables or screened unshielded multi-twisted-pair cables for I/O Signal Cables and Encoder Cables.**
- **The maximum wiring length is 3 m for I/O Signal Cables, and 50 m for Encoder Cables or Servomotor Main Circuit Cables.**
- **Observe the following precautions when wiring the SERVOPACK's main circuit terminals.**
 - Turn ON the power supply to the SERVOPACK only after all wiring, including the main circuit terminals, has been completed.
 - If a connector is used for the main circuit terminals, remove the main circuit connector from the SERVOPACK before you wire it.
 - Insert only one wire per insertion hole in the main circuit terminals.
 - When you insert a wire, make sure that the conductor wire (e.g., whiskers) does not come into contact with adjacent wires.

NOTICE

- **Whenever possible, use the Cables specified by Yaskawa.**
If you use any other cables, confirm the rated current and application environment of your model and use the wiring materials specified by Yaskawa or equivalent materials.
- **Securely tighten cable connector screws and lock mechanisms.**
Insufficient tightening may result in cable connectors falling off during operation.
- **Do not bundle power lines (e.g., the Main Circuit Cable) and low-current lines (e.g., the I/O Signal Cables or Encoder Cables) together or run them through the same duct. If you do not place power lines and low-current lines in separate ducts, separate them by at least 30 cm.**
If the cables are too close to each other, malfunctions may occur due to noise affecting the low-current lines.
- **For a motor with a cooling fan, check the rotation direction of the cooling fan after you wire the fan.**
- **Install a battery at either the host controller or on the Encoder Cable.**
If you install batteries both at the host controller and on the Encoder Cable at the same time, you will create a loop circuit between the batteries, resulting in a risk of damage or burning.
- **When connecting a battery, connect the polarity correctly.**
There is a risk of battery rupture or encoder failure.

■ Operation Precautions



WARNING

- Before starting operation with a machine connected, change the settings of the switches and parameters to match the machine.
Unexpected machine operation, failure, or personal injury may occur if operation is started before appropriate settings are made.
- Do not radically change the settings of the parameters.
There is a risk of unstable operation, machine damage, or injury.
- Install limit switches or stoppers at the ends of the moving parts of the machine to prevent unexpected accidents.
There is a risk of machine damage or injury.
- For trial operation, securely mount the Servomotor and disconnect it from the machine.
There is a risk of injury.
- Forcing the motor to stop for overtravel is disabled when the Jog, Origin Search, or Easy FFT utility function is executed. Take necessary precautions.
There is a risk of machine damage or injury.
- When an alarm occurs, the Servomotor will coast to a stop or stop with the dynamic brake according to the SERVOPACK Option and settings. The coasting distance will change with the moment of inertia of the load and the resistance of the External Dynamic Brake Resistor. Check the coasting distance during trial operation and implement suitable safety measures on the machine.
- Do not enter the machine's range of motion during operation.
There is a risk of injury.
- Do not touch the moving parts of the Servomotor or machine during operation.
There is a risk of injury.



CAUTION

- Do not use the holding brake built into a Servomotor to stop the Servomotor. The holding brake is designed to hold the motor shaft. It is not designed as a stopping device to ensure machine safety. Provide an appropriate stopping device on the machine to ensure safety.
There is a risk of brake failure due to wear, damage to the machine, or injury.
- Before you operate a Servomotor, supply power to the holding brake to release the holding brake. Refer to the timing charts in your Servomotor manual for details.
- During trial operation, confirm that the holding brake works correctly.
- When overtravel occurs, the power supply to the motor is turned OFF and the brake is released. If you use the Servomotor to drive a vertical load, set the Servomotor to enter a zero-clamped state after the Servomotor stops. Also, install safety devices (such as an external brake or counterweight) to prevent the moving parts of the machine from falling.
- Always turn OFF the servo before you turn OFF the power supply. If you turn OFF the main circuit power supply or control power supply during operation before you turn OFF the servo, the Servomotor will stop as follows:
 - If you turn OFF the main circuit power supply during operation without turning OFF the servo, the Servomotor will stop abruptly with the dynamic brake.
 - If you turn OFF the control power supply without turning OFF the servo, the stopping method that is used by the Servomotor depends on the model of the SERVOPACK. For details, refer to the manual for the SERVOPACK.

NOTICE

- Always measure the vibration of the Servomotor with the Servomotor mounted to the machine and confirm that the vibration is within the allowable value.
If the vibration is too large, the Servomotor will be damaged quickly and bolts may become loose.
- When you adjust the gain during system commissioning, use a measuring instrument to monitor the torque waveform and speed waveform and confirm that there is no vibration.
If a high gain causes vibration, the Servomotor will be damaged quickly.
- An alarm or warning may occur if communications are performed with the host controller while the SigmaWin+ or Digital Operator is operating.
If an alarm or warning occurs, it may interrupt the current process and stop the system.

■ Maintenance and Inspection Precautions



DANGER

- Do not change any wiring while power is being supplied.
There is a risk of electric shock or injury.



WARNING

- Wiring and inspections must be performed only by qualified engineers.
There is a risk of electric shock or product failure.
- If you replace a Servomotor with a Holding Brake, secure the machine before you replace the Servomotor.
There is a risk of injury or equipment damage if the equipment falls.



CAUTION

- Wait for at least six minutes after turning OFF the power supply (with a SERVOPACK for a 100-VAC power supply input, wait for at least nine minutes) and then make sure that the CHARGE indicator is not lit before starting wiring or inspection work. Do not touch the power supply terminals while the CHARGE lamp is lit after turning OFF the power supply because high voltage may still remain in the SERVOPACK.
There is a risk of electric shock.
- Replace the Battery according to the correct procedure.
If you remove the Battery or disconnect the Encoder Cable while the control power supply to the SERVOPACK is OFF, the absolute encoder data will be lost and position deviation may occur.

■ Troubleshooting Precautions



WARNING

- The product may suddenly start to operate when the power supply is recovered after a momentary power interruption. Design the machine to ensure human safety when operation restarts.
There is a risk of injury.



CAUTION

- When an alarm occurs, remove the cause of the alarm and ensure safety. Then reset the alarm or turn the power supply OFF and ON again to restart operation.
There is a risk of injury or machine damage.
- If the Servo ON signal is input to the SERVOPACK and an alarm is reset, the Servomotor may suddenly restart operation. Confirm that the servo is OFF and ensure safety before you reset an alarm.
There is a risk of injury or machine damage.
- The holding brake on a Servomotor will not ensure safety if there is the possibility that an external force (including gravity) may move the current position and create a hazardous situation when power is interrupted or an error occurs. If an external force may cause movement, install an external braking mechanism that ensures safety.

■ Disposal Precautions

- When disposing of the product, treat it as ordinary industrial waste. However, local ordinances and national laws must be observed. Implement all labeling and warnings as a final product as required.

■ General Precautions

- Figures provided in this document are typical examples or conceptual representations. There may be differences between them and actual wiring, circuits, and products.
- The products shown in illustrations in this document are sometimes shown without covers or protective guards. Always replace all covers and protective guards before you use the product.
- If you need a new copy of this document because it has been lost or damaged, contact your nearest Yaskawa representative or one of the offices listed on the back of this document.
- This document is subject to change without notice for product improvements, specifications changes, and improvements to the manual itself.
We will update the document number of the document and issue revisions when changes are made.
- Any and all quality guarantees provided by Yaskawa are null and void if the customer modifies the product in any way. Yaskawa disavows any responsibility for damages or losses that are caused by modified products.

Warranty

◆ Details of Warranty

■ Warranty Period

The warranty period for a product that was purchased (hereinafter called the “delivered product”) is one year from the time of delivery to the location specified by the customer or 18 months from the time of shipment from the Yaskawa factory, whichever is sooner.

■ Warranty Scope

Yaskawa shall replace or repair a defective product free of charge if a defect attributable to Yaskawa occurs during the above warranty period.

This warranty does not cover defects caused by the delivered product reaching the end of its service life and replacement of parts that require replacement or that have a limited service life.

This warranty does not cover failures that result from any of the following causes.

- Improper handling, abuse, or use in unsuitable conditions or in environments not described in product catalogs or manuals, or in any separately agreed-upon specifications
- Causes not attributable to the delivered product itself
- Modifications or repairs not performed by Yaskawa
- Use of the delivered product in a manner in which it was not originally intended
- Causes that were not foreseeable with the scientific and technological understanding at the time of shipment from Yaskawa
- Events for which Yaskawa is not responsible, such as natural or human-made disasters

◆ Limitations of Liability

- Yaskawa shall in no event be responsible for any damage or loss of opportunity to the customer that arises due to failure of the delivered product.
- Yaskawa shall not be responsible for any programs (including parameter settings) or the results of program execution of the programs provided by the user or by a third party for use with programmable Yaskawa products.
- The information described in product catalogs or manuals is provided for the purpose of the customer purchasing the appropriate product for the intended application. The use thereof does not guarantee that there are no infringements of intellectual property rights or other proprietary rights of Yaskawa or third parties, nor does it construe a license.
- Yaskawa shall not be responsible for any damage arising from infringements of intellectual property rights or other proprietary rights of third parties as a result of using the information described in catalogs or manuals.

◆ Suitability for Use

- It is the customer's responsibility to confirm conformity with any standards, codes, or regulations that apply if the Yaskawa product is used in combination with any other products.
- The customer must confirm that the Yaskawa product is suitable for the systems, machines, and equipment used by the customer.
- Consult with Yaskawa to determine whether use in the following applications is acceptable. If use in the application is acceptable, use the product with extra allowance in ratings and specifications, and provide safety measures to minimize hazards in the event of failure.
 - Outdoor use, use involving potential chemical contamination or electrical interference, or use in conditions or environments not described in product catalogs or manuals
 - Nuclear energy control systems, combustion systems, railroad systems, aviation systems, vehicle systems, medical equipment, amusement machines, and installations subject to separate industry or government regulations
 - Systems, machines, and equipment that may present a risk to life or property
 - Systems that require a high degree of reliability, such as systems that supply gas, water, or electricity, or systems that operate continuously 24 hours a day
 - Other systems that require a similar high degree of safety
- Never use the product for an application involving serious risk to life or property without first ensuring that the system is designed to secure the required level of safety with risk warnings and redundancy, and that the Yaskawa product is properly rated and installed.
- The circuit examples and other application examples described in product catalogs and manuals are for reference. Check the functionality and safety of the actual devices and equipment to be used before using the product.
- Read and understand all use prohibitions and precautions, and operate the Yaskawa product correctly to prevent accidental harm to third parties.

◆ Specifications Change

The names, specifications, appearance, and accessories of products in product catalogs and manuals may be changed at any time based on improvements and other reasons. The next editions of the revised catalogs or manuals will be published with updated code numbers. Consult with your Yaskawa representative to confirm the actual specifications before purchasing a product.

Compliance with UL Standards, EU Directives, and Other Safety Standards

Certification marks for the standards for which the product has been certified by certification bodies are shown on nameplate. Products that do not have the marks are not certified for the standards.

◆ North American Safety Standards (UL)



Product	Model	North American Safety Standards (UL File No.)
SERVOPACKs	• SGD7S • SGD7W	UL 61800-5-1 (E147823) CSA C22.2 No.274
	SGDV	UL508C (E147823)
Rotary Servomotors	• SGM7M • SGM7A • SGM7J • SGM7P • SGM7G • SGMMV	UL 1004-1 UL 1004-6 (E165827)
Direct Drive Servomotors	• SGM7E • SGM7F-□□A, -□□B, -□□C, and -□□D (Small-Capacity Servomotors with Cores) • SGMCV • SGMCS-□□B, -□□C, -□□D, and -□□E (Small-Capacity, Coreless Servomotors)	UL 1004-1 UL 1004-6 (E165827)
Linear Servomotors	• SGLGW* • SGLFW* • SGLFW2 • SGLTW*	UL 1004-1 UL 1004-6 (E165827)

* Only products with derating specifications are in compliance with the UL Standards. Estimates are available for those products. Contact your Yaskawa representative for details.

◆ EU Directives



Product	Model	EU Directives	Harmonized Standards
SERVOPACKs	SGD7S	Machinery Directive 2006/42/EC	EN ISO13849-1: 2015
		EMC Directive 2014/30/EU	EN 55011 group 1, class A EN 61000-6-2 EN 61000-6-4 EN 61800-3 (Category C2, Second environment)
		Low Voltage Directive 2014/35/EU	EN 50178 EN 61800-5-1
		RoHS Directive 2011/65/EU	EN 50581

Continued on next page.

Continued from previous page.

Product	Model	EU Directives	Harmonized Standards
SERVOPACKs	<ul style="list-style-type: none"> • SGD7W • SGDv 	EMC Directive 2014/30/EU	EN 55011 group 1, class A EN 61000-6-2 EN 61000-6-4 EN 61800-3 (Category C2, Second environment)
		Low Voltage Directive 2014/35/EU	EN 50178 EN 61800-5-1
		RoHS Directive 2011/65/EU	EN 50581
Rotary Servomotors	SGMMV	EMC Directive 2004/108/EC	EN 55011 group 1, class A EN 61000-6-2 EN 61800-3 (Category C2, Second environment)
		Low Voltage Directive 2006/95/EC	EN 60034-1 EN 60034-5
		RoHS Directive 2011/65/EU	EN 50581
	<ul style="list-style-type: none"> • SGM7M • SGM7J • SGM7A • SGM7P • SGM7G 	EMC Directive 2014/30/EU	EN 55011 group 1, class A EN 61000-6-2 EN 61000-6-4 EN 61800-3 (Category C2, Second environment)
		Low Voltage Directive 2014/35/EU	EN 60034-1 EN 60034-5
		RoHS Directive 2011/65/EU	EN 50581
Direct Drive Servomotors	<ul style="list-style-type: none"> • SGM7E • SGM7F • SGMCV • SGMCS-□□B, -□□C, -□□D, and -□□E (Small-Capacity, Coreless Servomotors) 	EMC Directive 2014/30/EU	EN 55011 group 1, class A EN 61000-6-2 EN 61000-6-4 EN 61800-3 (Category C2, Second environment)
		Low Voltage Directive 2014/35/EU	EN 60034-1 EN 60034-5
		RoHS Directive 2011/65/EU	EN 50581
Linear Servomotors	<ul style="list-style-type: none"> • SGLG* • SGLF* • SGLF□2 • SGLT* 	EMC Directive 2014/30/EU	EN 55011 group 1, class A EN 61000-6-2 EN 61000-6-4 EN 61800-3 (Category C2, Second environment)
		Low Voltage Directive 2014/35/EU	EN 60034-1
		RoHS Directive 2011/65/EU	EN 50581

* For Moving Coils, only models with "-E" at the end of model numbers are certified.

Note: 1. We declared the CE Marking based on the harmonized standards in the above table.

2. These products are for industrial use. In home environments, these products may cause electromagnetic interference and additional noise reduction measures may be necessary.

◆ Safety Standards



Product	Model	Safety Standards	Standards
SERVOPACKs	SGD7S	Safety of Machinery	EN ISO13849-1: 2015 IEC 60204-1
		Functional Safety	IEC 61508 series IEC 62061 IEC 61800-5-2
		EMC	IEC 61326-3-1

■ Safety Parameters

Item	Standards	Performance Level	
Safety Integrity Level	IEC 61508	SIL3	
	IEC 62061	SILCL3	
Mission Time	IEC 61508	10 years	20 years
Probability of Dangerous Failure per Hour	IEC 61508 IEC 62061	PFH = 4.04×10^{-9} [1/h] (4.04% of SIL3)	PFH = 4.05×10^{-9} [1/h] (4.05% of SIL3)
Performance Level	EN ISO 13849-1	PLe (Category 3)	
Mean Time to Dangerous Failure of Each Channel	EN ISO 13849-1	MTTFd: High	
Average Diagnostic Coverage	EN ISO 13849-1	DCavg: Medium	
Stop Category	IEC 60204-1	Stop category 0	
Safety Function	IEC 61800-5-2	STO	
Hardware Fault Tolerance	IEC 61508	HFT = 1	
Subsystem	IEC 61508	B	

Contents

About this Manual	iii
Outline of Manual	iii
Related Documents	iv
Using This Manual	xi
Safety Precautions	xii
Warranty	xxi
Compliance with UL Standards, EU Directives, and Other Safety Standards. . .	xxiii

1

Basic Information on Servomotors

1.1	Servomotor Part Names	1-2
1.1.1	SGM7M and SGMMV Servomotors	1-2
1.1.2	SGM7J and SGM7A Servomotors Up to 1.0 kW and SGM7P Servomotors Up to 400 W	1-2
1.1.3	SGM7G Servomotors Up to 450 W	1-2
1.1.4	SGM7A Servomotors of 1.5 kW to 5.0 kW and SGM7G Servomotors of 850 W and Higher	1-3
1.1.5	SGM7A Servomotors of 7.0 kW	1-3
1.1.6	SGM7P Servomotors of 750 W and 1.5 kW	1-3
1.2	Interpreting the Nameplates.	1-4
1.2.1	SGM7M Servomotors	1-4
1.2.2	SGM7J, SGM7A, SGM7P, and SGM7G Servomotors	1-4
1.2.3	SGMMV Servomotors	1-5
1.3	Outline of Model Designations	1-6
1.3.1	Servomotor.	1-6
1.3.2	SERVOPACKs.	1-6
1.4	Combinations of Servomotors and SERVOPACKs.	1-7
1.4.1	Combination of Servomotors and SERVOPACKs for AC Power Input	1-7
1.4.2	Combination of Servomotors and SERVOPACKs for DC Power Input.	1-8

2

Capacity Selection

2.1	Selecting the Servomotor Capacity	2-2
2.1.1	Capacity Selection Example for a Rotary Servomotor: For Speed Control	2-2
2.1.2	Capacity Selection Example for a Rotary Servomotor: For Position Control	2-4

3

Specifications, Ratings, and External Dimensions of SGM7M Servomotors

3.1	Model Designations	3-2
------------	-------------------------------------	------------

3.2	Specifications and Ratings	3-3
3.2.1	Specifications	3-3
3.2.2	Servomotor Ratings (SGM7M-□□E)	3-4
3.2.3	Torque-Motor Speed Characteristics (SGM7M-□□E)	3-5
3.2.4	Servomotor Overload Protection Characteristics (SGM7M-□□E)	3-5
3.2.5	Servomotor Ratings (SGM7M-□□A)	3-6
3.2.6	Torque-Motor Speed Characteristics (SGM7M-□□A)	3-7
3.2.7	Servomotor Overload Protection Characteristics (SGM7M-□□A)	3-7
3.2.8	Allowable Load Moment of Inertia	3-8
3.2.9	Derating Rates	3-9
3.3	External Dimensions	3-10
3.3.1	Servomotors without Holding Brakes	3-10
3.3.2	Servomotors with Holding Brakes	3-12

4 Specifications, Ratings, and External Dimensions of SGM7J Servomotors

4.1	Model Designations	4-2
4.1.1	Without Gears	4-2
4.1.2	With Gears	4-2
4.2	Specifications and Ratings	4-3
4.2.1	Specifications	4-3
4.2.2	Ratings of Servomotors without Gears	4-4
4.2.3	Torque-Motor Speed Characteristics	4-5
4.2.4	Ratings of Servomotors with Gears	4-6
4.2.5	Servomotor Overload Protection Characteristics	4-8
4.2.6	Allowable Load Moment of Inertia	4-9
4.2.7	Derating Rates	4-10
4.3	External Dimensions	4-11
4.3.1	Servomotors without Gears	4-11
4.3.2	Servomotors with Gears	4-14

5 Specifications, Ratings, and External Dimensions of SGM7A Servomotors

5.1	Model Designations	5-2
5.1.1	Without Gears	5-2
5.1.2	With Gears	5-2
5.2	Specifications and Ratings	5-3
5.2.1	Specifications	5-3
5.2.2	Ratings of Servomotors without Gears for the SGM7A-A5 to -10	5-4
5.2.3	Torque-Motor Speed Characteristics of the SGM7A-A5 to -10	5-6
5.2.4	Ratings of Servomotors without Gears for the SGM7A-15 to -70	5-7
5.2.5	Torque-Motor Speed Characteristics of the SGM7A-15 to -70	5-9
5.2.6	Ratings of Servomotors with Gears	5-10
5.2.7	Servomotor Overload Protection Characteristics	5-12
5.2.8	Allowable Load Moment of Inertia	5-13
5.2.9	Derating Rates	5-14

5.3	External Dimensions	5-16
5.3.1	Servomotors without Gears	5-16
5.3.2	Servomotors without Gears and without Holding Brakes	5-19
5.3.3	Servomotors without Gears and with Holding Brakes	5-22
5.3.4	Servomotors with Gears	5-25

6

Specifications, Ratings, and External Dimensions of SGM7P Servomotors

6.1	Model Designations	6-2
6.1.1	Without Gears	6-2
6.1.2	With Gears	6-2
6.2	Specifications and Ratings	6-3
6.2.1	Specifications	6-3
6.2.2	Ratings of Servomotors without Gears	6-4
6.2.3	Torque-Motor Speed Characteristics	6-5
6.2.4	Ratings of Servomotors with Gears	6-6
6.2.5	Servomotor Overload Protection Characteristics	6-8
6.2.6	Allowable Load Moment of Inertia	6-8
6.2.7	Derating Rates	6-9
6.3	External Dimensions	6-11
6.3.1	Servomotors without Gears	6-11
6.3.2	Servomotors with Gears	6-13

7

Specifications, Ratings, and External Dimensions of SGM7G Servomotors

7.1	Model Designations	7-2
7.2	Specifications and Ratings	7-3
7.2.1	Specifications	7-3
7.2.2	Servomotor Ratings of the SGM7G-03 to -20	7-4
7.2.3	Torque-Motor Speed Characteristics of the SGM7G-03 to -20	7-5
7.2.4	Servomotor Ratings of the SGM7G-30 to -1E	7-6
7.2.5	Torque-Motor Speed Characteristics of the SGM7G-30 to -1E	7-7
7.2.6	Servomotor Overload Protection Characteristics	7-8
7.2.7	Allowable Load Moment of Inertia	7-9
7.2.8	Derating Rates	7-9
7.3	External Dimensions	7-11
7.3.1	Servomotors without Holding Brakes	7-11
7.3.2	Servomotors with Holding Brakes	7-14

8

Specifications, Ratings, and External Dimensions of SGMMV Servomotors

8.1	Model Designations	8-2
------------	---------------------------	------------

8.2	Specifications and Ratings	8-3
8.2.1	Specifications	8-3
8.2.2	Servomotor Ratings	8-4
8.2.3	Torque-Motor Speed Characteristics	8-5
8.2.4	Servomotor Overload Protection Characteristics	8-5
8.2.5	Allowable Load Moment of Inertia	8-6
8.2.6	Derating Rates	8-7
8.3	External Dimensions	8-8
8.3.1	Servomotors without Holding Brakes	8-8
8.3.2	Servomotors with Holding Brakes	8-9

9

Servomotor Installation

9.1	Installation Conditions	9-2
9.1.1	Installation Precautions	9-2
9.1.2	Installation Environment	9-3
9.1.3	Installation Orientation	9-3
9.1.4	Using Servomotors with Oil Seals	9-3
9.1.5	Using Servomotors with Holding Brakes	9-4
9.2	Coupling to the Machine	9-5
9.2.1	Using a Coupling	9-5
9.2.2	Using a Belt	9-6
9.3	Oil and Water Countermeasures	9-8
9.4	Servomotor Temperature Increase	9-9

10

Connections between Servomotors and SERVOPACKs

10.1	Cables for the SGM7M Servomotors	10-3
10.1.1	Cable Configurations	10-3
10.1.2	Servomotor Main Circuit Cables	10-4
10.1.3	Encoder Cables	10-4
10.2	Cables for the SGM7J Servomotors	10-5
10.2.1	System Configurations	10-5
10.2.2	Servomotor Main Circuit Cables	10-6
10.2.3	Encoder Cables of 20 m or Less	10-9
10.2.4	Relay Encoder Cable of 30 m to 50 m	10-9
10.3	Cables for the SGM7A Servomotors	10-10
10.3.1	Cable Configurations	10-10
10.3.2	Servomotor Main Circuit Cables	10-11
10.3.3	Encoder Cables of 20 m or Less	10-16
10.3.4	Relay Encoder Cable of 30 m to 50 m	10-17

10.4	Cables for the SGM7P Servomotors	10-18
10.4.1	System Configurations	10-18
10.4.2	Servomotor Main Circuit Cables	10-19
10.4.3	Encoder Cables of 20 m or Less	10-21
10.4.4	Relay Encoder Cables of 30 m to 50 m	10-21
10.5	Cables for the SGM7G Servomotors	10-22
10.5.1	System Configurations	10-22
10.5.2	Servomotor Main Circuit Cables	10-23
10.5.3	Encoder Cables of 20 m or Less	10-30
10.5.4	Relay Encoder Cables of 30 m to 50 m	10-30
10.6	Cables for the SGMMV Servomotors	10-31
10.6.1	System Configurations	10-31
10.6.2	Servomotor Main Circuit Cables	10-32
10.6.3	Encoder Cables of 20 m or Less	10-32
10.6.4	Relay Encoder Cables of 30 m to 50 m	10-33
10.7	Wiring Servomotors and SERVOPACKs	10-34
10.7.1	Wiring Precautions	10-34
10.7.2	Wiring Procedure	10-37

11

Maintenance and Inspection

11.1	Periodic Inspections	11-2
11.2	Service Lives of Parts	11-3
11.3	Disposing of Servomotors	11-4

12

Appendices

12.1	Terminology and Data for Servomotors with Gears	12-2
12.1.1	Terminology for Servomotors with Low-backlash Gears	12-2
12.1.2	Noise Data	12-2
12.1.3	Efficiency	12-3
12.2	Reference Information for Servomotor Capacity Selection	12-4
12.2.1	Formulas Required to Select the Servomotor Capacity	12-4
12.2.2	GD^2 for Simple Diagrams	12-5
12.2.3	Conversions between Engineering Units and SI Units	12-6
12.2.4	Application Examples by Type of Application	12-7

Revision History

Basic Information on Servomotors

1

This chapter provides basic information on Rotary Servomotors, including Servomotor part names and combinations with SERVOPACKs.

1.1 Servomotor Part Names 1-2

- 1.1.1 SGM7M and SGMMV Servomotors 1-2
- 1.1.2 SGM7J and SGM7A Servomotors Up to 1.0 kW and SGM7P Servomotors Up to 400 W 1-2
- 1.1.3 SGM7G Servomotors Up to 450 W 1-2
- 1.1.4 SGM7A Servomotors of 1.5 kW to 5.0 kW and SGM7G Servomotors of 850 W and Higher 1-3
- 1.1.5 SGM7A Servomotors of 7.0 kW 1-3
- 1.1.6 SGM7P Servomotors of 750 W and 1.5 kW 1-3

1.2 Interpreting the Nameplates 1-4

- 1.2.1 SGM7M Servomotors 1-4
- 1.2.2 SGM7J, SGM7A, SGM7P, and SGM7G Servomotors 1-4
- 1.2.3 SGMMV Servomotors 1-5

1.3 Outline of Model Designations 1-6

- 1.3.1 Servomotor 1-6
- 1.3.2 SERVOPACKs 1-6

1.4 Combinations of Servomotors and SERVOPACKs . . 1-7

- 1.4.1 Combination of Servomotors and SERVOPACKs for AC Power Input 1-7
- 1.4.2 Combination of Servomotors and SERVOPACKs for DC Power Input 1-8

1.1 Servomotor Part Names

1.1.1 SGM7M and SGMMV Servomotors

• Standard Servomotors

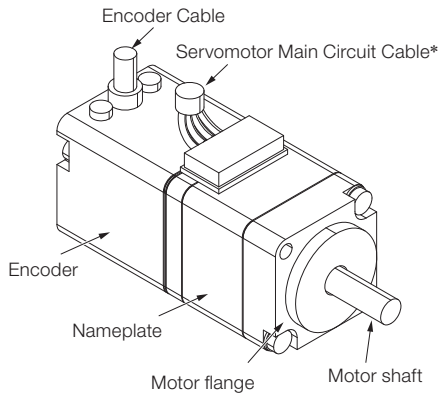

• Servomotors with Brakes

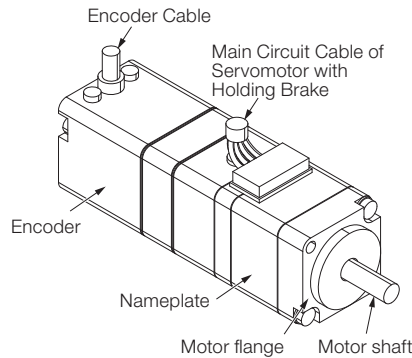

* Some models also have cables on the motor shaft side.

1.1.2 SGM7J and SGM7A Servomotors Up to 1.0 kW and SGM7P Servomotors Up to 400 W

• Standard Servomotors

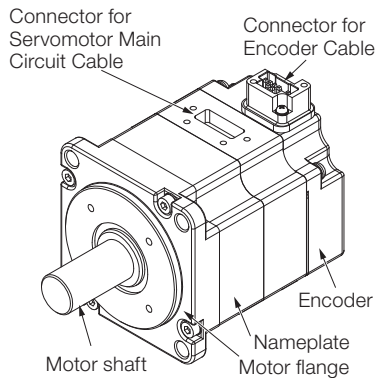

• Servomotors with Brakes

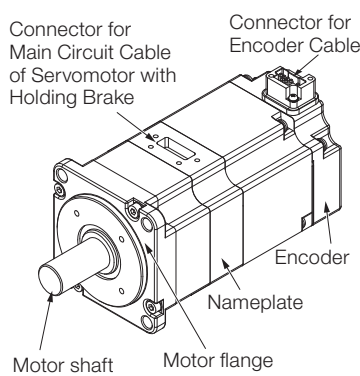

• Servomotors with Gears

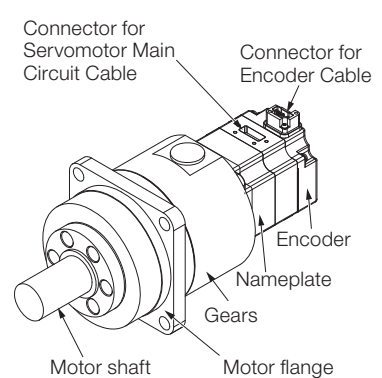

1.1.3 SGM7G Servomotors Up to 450 W

• Standard Servomotors

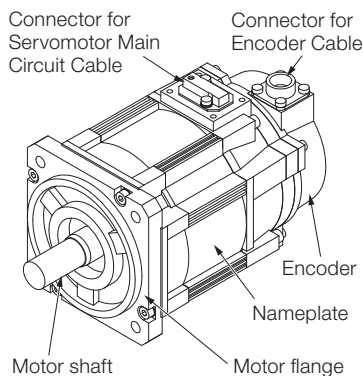

• Servomotors with Brakes

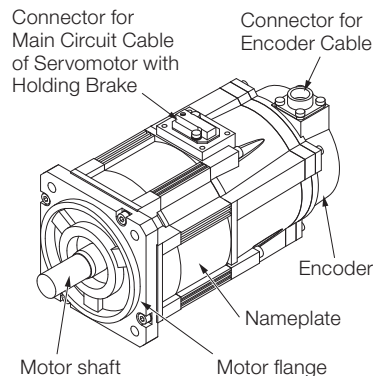

1.1.4 SGM7A Servomotors of 1.5 kW to 5.0 kW and SGM7G Servomotors of 850 W and Higher

- Standard Servomotors

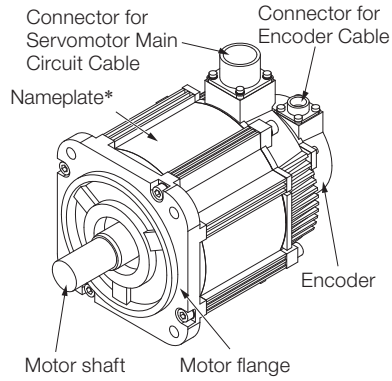

- Servomotors with Brakes

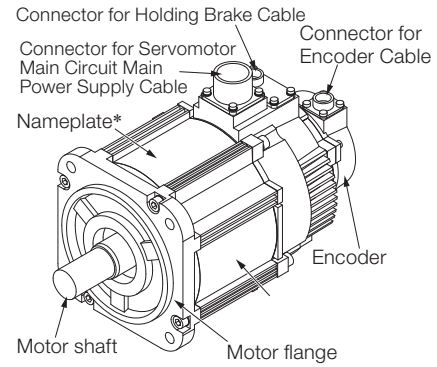

* The position of the nameplate depends on the model and motor output.

1.1.5 SGM7A Servomotors of 7.0 kW

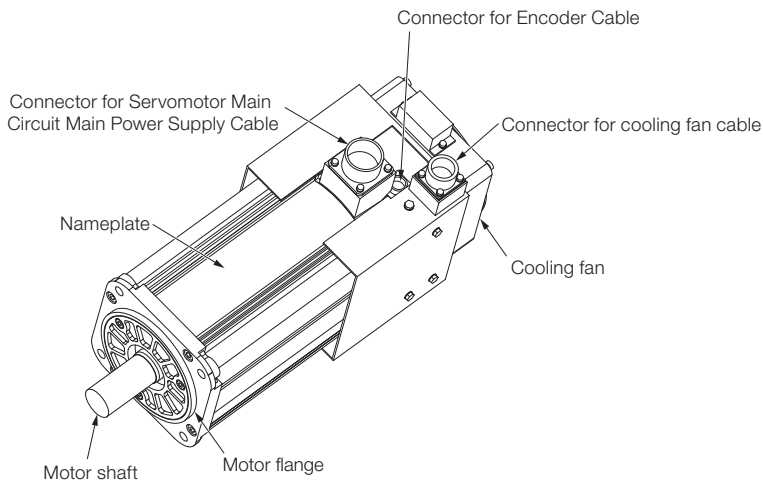

1.1.6 SGM7P Servomotors of 750 W and 1.5 kW

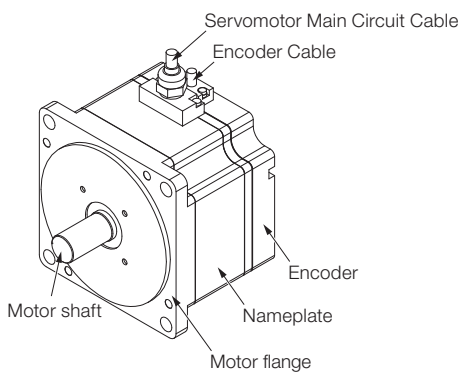

1.2 Interpreting the Nameplates

The following basic information is provided on the nameplate.

1.2.1 SGM7M Servomotors

A nameplate containing the following information is attached to the Servomotor.

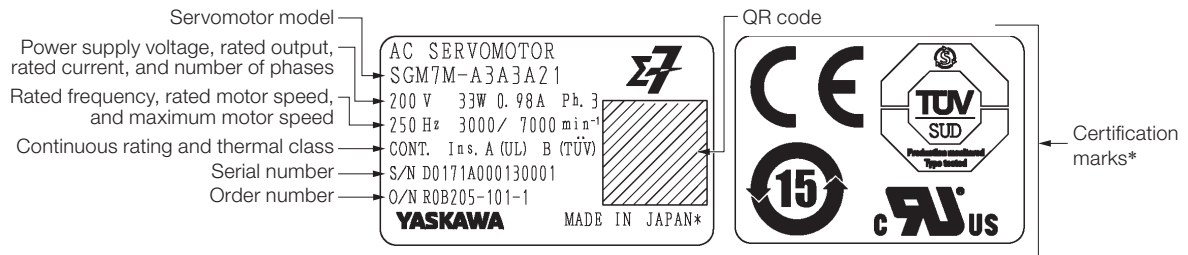

* Certification marks for the standards for which the Servomotor has been certified by certification bodies are shown on the product.

1.2.2 SGM7J, SGM7A, SGM7P, and SGM7G Servomotors

The nameplate is printed on the Servomotor.

The layout of the nameplate depends somewhat on the model of the Servomotor.

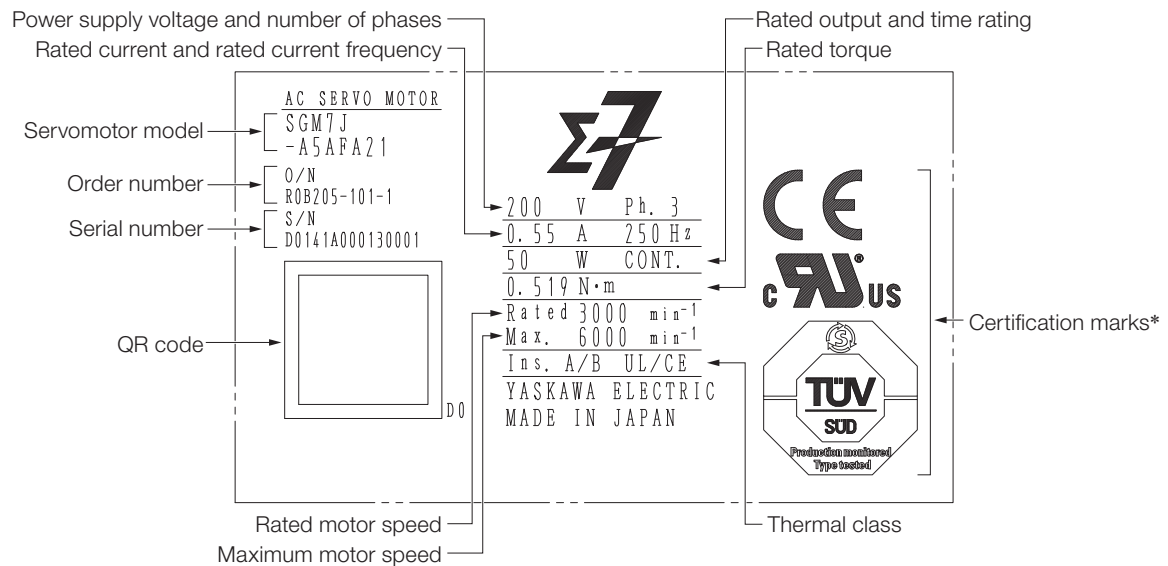

* Certification marks for the standards for which the Servomotor has been certified by certification bodies are shown on the product.

1.2.3 SGMMV Servomotors

A nameplate containing the following information is attached to the Servomotor.

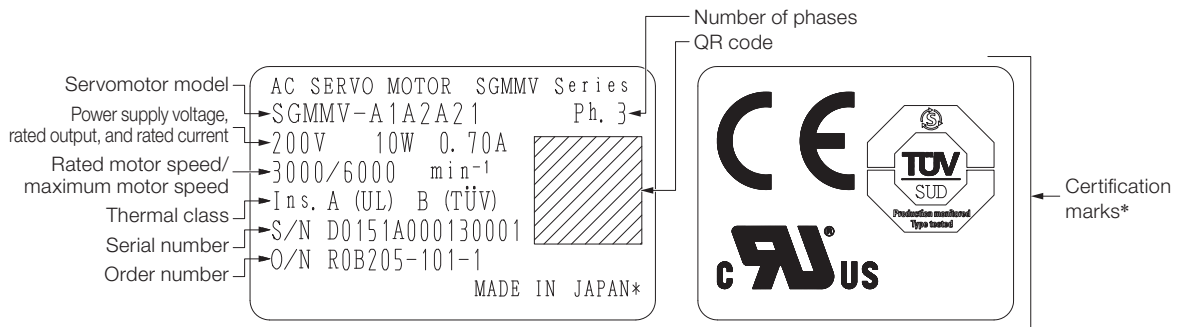

* Certification marks for the standards for which the Servomotor has been certified by certification bodies are shown on the product.

1.3 Outline of Model Designations

1.3.1 Servomotor

This section outlines the model numbers of Σ -7-Series Servomotors. For details, refer to the chapter for your type of Servomotor.



Code	Specifications	Reference
SGM7M	Low inertia, ultra-small capacity	Chapter 3
SGM7J	Medium inertia, high speed	Chapter 4
SGM7A	Low inertia, high speed	Chapter 5
SGM7P	Medium inertia, flat	Chapter 6
SGM7G	Medium inertia, low speed, high torque	Chapter 7
SGMMV	Low inertia, ultra-small capacity	Chapter 8

1st+2nd digits Rated Output

3rd digit Power Supply Voltage

- 200 VAC
- 24 VDC/48 VDC*

4th digit Serial Encoder Specification

- 17-bit absolute encoder
- 20-bit absolute encoder
- 24-bit batteryless absolute encoder
- 24-bit absolute encoder
- 24-bit incremental encoder

5th digit Design Revision Order

6th digit Shaft End Specification

- Straight without key
- Straight with key and tap
- With flat seat
- With two flat seats

7th digit Options

- With 24-V holding brake
- With oil seal

* This specification must be used with SGD V SERVOPACKs (Σ -V Series).

1.3.2 SERVOPACKs

This section outlines the model numbers of Σ -7-Series SERVOPACKs. For details, refer to the manual for your SERVOPACK.

- 📖 Σ -7-Series Σ -7S SERVOPACK with Analog Voltage/Pulse Train References Product Manual (Manual No.: SIEP S800001 26)
- 📖 Σ -7-Series Σ -7S SERVOPACK with MECHATROLINK-II Communications References Product Manual (Manual No.: SIEP S800001 27)
- 📖 Σ -7-Series Σ -7S SERVOPACK with MECHATROLINK-III Communications References Product Manual (Manual No.: SIEP S800001 28)
- 📖 Σ -7-Series Σ -7W SERVOPACK with MECHATROLINK-III Communications References Product Manual (Manual No.: SIEP S800001 29)



Code	Specification
SGD7S	Single-axis SERVOPACKs
SGD7W	Two-axis SERVOPACKs

1st+2nd+3rd digits Maximum Applicable Motor Capacity

0.05 kW to 15 kW

4th digit Power Supply Voltage

- 200 VAC

5th+6th digits Interface

- Analog voltage/pulse train reference
- MECHATROLINK-II communications reference
- MECHATROLINK-III communications reference

7th digit Design Revision Order

8th+9th+10th digits Options

- Rack-mounted installation
- Varnished

SGM7M Servomotors with DC power supply input must be used with SGD V SERVOPACKs (Σ -V Series). For details, refer to the manual for your SERVOPACK.

- 📖 DC Power Input Σ -V Series User's Manual, Design and Maintenance, Rotational Motor, Analog Voltage Reference and Pulse Train Reference (Manual No.: SIEP S800000 81)
- 📖 DC Power Input Σ -V Series User's Manual, Design and Maintenance, Rotational Motor, MECHATROLINK-II Communications Reference (Manual No.: SIEP S800000 82)
- 📖 DC Power Input Σ -V Series User's Manual, Design and Maintenance, Rotational Motor, MECHATROLINK-III Communications Reference (Manual No.: SIEP S800000 83)
- 📖 Σ -V-MD Series User's Manual, Type A01/A02, Rotational Motor, MECHATROLINK-III Communications References (Manual No.: SIEP S800001 02)

1.4

Combinations of Servomotors and SERVOPACKs

1.4.1

Combination of Servomotors and SERVOPACKs for AC Power Input

Rotary Servomotor Model		Capacity	SERVOPACK Model	
			SGD7S-□□□□	SGD7W-□□□□ SGD7C-□□□□
SGM7M (Low inertia, ultra-small capacity) 3000 min ⁻¹	SGM7M-A1A	11 W	R90A, R90F	1R6A* ¹ , 2R8A* ¹
	SGM7M-A2A	22 W		
	SGM7M-A3A	33 W	1R6A, 2R1F	1R6A, 2R8A* ¹
SGM7J (Medium inertia, high speed) 3000 min ⁻¹	SGM7J-A5A	50 W	R70A, R70F	1R6A* ¹ , 2R8A* ¹
	SGM7J-01A	100 W	R90A, R90F	
	SGM7J-C2A	150 W	1R6A, 2R1F	1R6A, 2R8A* ¹
	SGM7J-02A	200 W		
	SGM7J-04A	400 W	2R8A, 2R8F	2R8A, 5R5A* ¹ , 7R6A* ¹
	SGM7J-06A	600 W	5R5A	5R5A, 7R6A
	SGM7J-08A	750 W		
SGM7A (Low inertia, high speed) 3000 min ⁻¹	SGM7A-A5A	50 W	R70A, R70F	1R6A* ¹ , 2R8A* ¹
	SGM7A-01A	100 W	R90A, R90F	
	SGM7A-C2A	150 W	1R6A, 2R1F	1R6A, 2R8A* ¹
	SGM7A-02A	200 W		
	SGM7A-04A	400 W	2R8A, 2R8F	2R8A, 5R5A* ¹ , 7R6A* ¹
	SGM7A-06A	600 W	5R5A	5R5A, 7R6A
	SGM7A-08A	750 W		
	SGM7A-10A	1.0 kW	120A	-
	SGM7A-15A	1.5 kW		
	SGM7A-20A	2.0 kW	180A	
	SGM7A-25A	2.5 kW	200A	
	SGM7A-30A	3.0 kW		
	SGM7A-40A	4.0 kW	330A	
SGM7A-50A	5.0 kW			
SGM7A-70A	7.0 kW	550A		
SGM7P (Medium inertia, flat type) 3000min ⁻¹	SGM7P-01A	100 W	R90A, R90F	1R6A* ¹ , 2R8A* ¹
	SGM7P-02A	200 W	2R8A, 2R1F	2R8A, 5R5A* ¹ , 7R6A* ¹
	SGM7P-04A	400 W	2R8A, 2R8F	
	SGM7P-08A	750 W	5R5A	5R5A, 7R6A
	SGM7P-15A	1.5 kW	120A	-

Continued on next page.

1.4 Combinations of Servomotors and SERVOPACKS

1.4.2 Combination of Servomotors and SERVOPACKS for DC Power Input

Continued from previous page.

Rotary Servomotor Model		Capacity	SERVOPACK Model		
			SGD7S-□□□□	SGD7W-□□□□ SGD7C-□□□□	
SGM7G (Medium inertia, low speed, large torque) 1500 min ⁻¹	SGM7G-03A	300 W	3R8A	5R5A* ¹ , 7R6A* ¹	
	SGM7G-05A	450 W			
	SGM7G-09A	850 W	7R6A		
	SGM7G-13A	1.3 kW	120A	-	
	SGM7G-20A	1.8 kW	180A		
	SGM7G-30A	2.9 kW* ²	330A		
	SGM7G-44A	4.4 kW			
	SGM7G-55A	5.5 kW	470A		
	SGM7G-75A	7.5 kW	550A		
	SGM7G-1AA	11 kW	590A		
SGM7G-1EA	15 kW	780A			
SGMMV* ³ (Low inertia, ultra-small capacity) 3000 min ⁻¹	SGMMV-A1A	10 W	R90A, R90F		1R6A* ¹ , 2R8A* ¹
	SGMMV-A2A	20 W			
	SGMMV-A3A	30 W	1R6A, 2R1F	1R6A, 2R8A* ¹	

*1. If you use the Servomotor together with a Σ-7W or Σ-7C SERVOPACK, the control gain may not increase as much as with a Σ-7S SERVOPACK and other performances may be lower than those achieved with a Σ-7S SERVOPACK.

*2. The rated output is 2.4 kW if you use the SGD7S-200A.

*3. The SGMMV model is an earlier product. Select the SGM7M model when newly installing a rotary servomotor to a machine.

1.4.2 Combination of Servomotors and SERVOPACKS for DC Power Input

Rotary Servomotor Model		Capacity	SERVOPACK Model
			SGDV-□□□□*
SGM7M (Low inertia, ultra-small capacity) 3000 min ⁻¹	SGM7M-B3E	3.3 W	1R7E
	SGM7M-B5E	5.5 W	
	SGM7M-B9E	11 W	
	SGM7M-A1E	11 W	2R9E
	SGM7M-A2E	22 W	
	SGM7M-A3E	33 W	

* These are Σ-V-series SERVOPACKS.

Capacity Selection



This chapter describes calculation methods to use when selecting Servomotor capacities.

2.1 Selecting the Servomotor Capacity 2-2

- 2.1.1 Capacity Selection Example for a Rotary Servomotor: For Speed Control 2-2
- 2.1.2 Capacity Selection Example for a Rotary Servomotor: For Position Control 2-4

2.1 Selecting the Servomotor Capacity

Contact your Yaskawa representative for information on the Servomotor capacity selection software. Refer to the following selection examples to select Servomotor capacities with manual calculations.

2.1.1 Capacity Selection Example for a Rotary Servomotor: For Speed Control

1. Mechanical Specifications

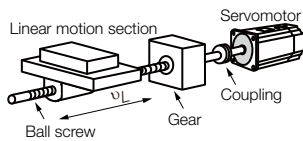

Item	Code	Value
Load Speed	v_L	15 m/min
Linear Motion Section Mass	m	250 kg
Ball Screw Length	ℓ_B	1.0 m
Ball Screw Diameter	d_B	0.02 m
Ball Screw Lead	P_B	0.01 m
Ball Screw Material Density	ρ	$7.87 \times 10^3 \text{ kg/m}^3$
Gear Ratio	R	2 (gear ratio: 1/2)
External Force on Linear Motion Section	F	0 N

Item	Code	Value
Gear and Coupling Moment of Inertia	J_G	$0.40 \times 10^{-4} \text{ kg}\cdot\text{m}^2$
Number of Feeding Operations	n	40 rotations/min
Feeding Distance	ℓ	0.275 m
Feeding Time	tm	1.2 s max.
Friction Coefficient	μ	0.2
Mechanical Efficiency	η	0.9 (90%)

2. Operation Pattern

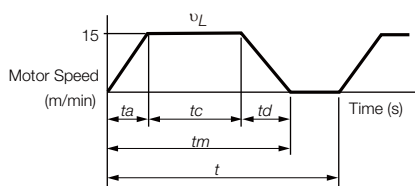

$$t = \frac{60}{n} = \frac{60}{40} = 1.5 \text{ (s)}$$

$$\text{If } ta = td,$$

$$ta = tm - \frac{60 \ell}{v_L} = 1.2 - \frac{60 \times 0.275}{15} = 1.2 - 1.1 = 0.1 \text{ (s)}$$

$$tc = 1.2 - 0.1 \times 2 = 1.0 \text{ (s)}$$

3. Motor Speed

- Load shaft speed $n_L = \frac{v_L}{P_B} = \frac{15}{0.01} = 1,500 \text{ (min}^{-1}\text{)}$

- Motor shaft speed $n_M = n_L \cdot R = 1,500 \times 2 = 3,000 \text{ (min}^{-1}\text{)}$

4. Load Torque

$$T_L = \frac{(9.8 \cdot \mu \cdot m + F) \cdot P_B}{2\pi R \cdot \eta} = \frac{(9.8 \times 0.2 \times 250 + 0) \times 0.01}{2\pi \times 2 \times 0.9} = 0.43 \text{ (N}\cdot\text{m)}$$

5. Load Moment of Inertia

- Linear motion section

$$J_{L1} = m \left(\frac{P_B}{2\pi R} \right)^2 = 250 \times \left(\frac{0.01}{2\pi \times 2} \right)^2 = 1.58 \times 10^{-4} \text{ (kg}\cdot\text{m}^2\text{)}$$

- Ball screw

$$J_B = \frac{\pi}{32} \rho \cdot \ell_B \cdot d_B^4 \cdot \frac{1}{R^2} = \frac{\pi}{32} \times 7.87 \times 10^3 \times 1.0 \times (0.02)^4 \cdot \frac{1}{2^2} = 0.31 \times 10^{-4} \text{ (kg}\cdot\text{m}^2\text{)}$$

- Coupling $J_G = 0.40 \times 10^{-4} \text{ (kg}\cdot\text{m}^2\text{)}$
- Load moment of inertia at motor shaft

$$J_L = J_{L1} + J_B + J_G = (1.58 + 0.31 + 0.40) \times 10^{-4} = 2.29 \times 10^{-4} \text{ (kg}\cdot\text{m}^2\text{)}$$

6. Load Moving Power

$$P_O = \frac{2\pi n_M \cdot T_L}{60} = \frac{2\pi \times 3,000 \times 0.43}{60} = 135 \text{ (W)}$$

7. Load Acceleration Power

$$P_a = \left(\frac{2\pi}{60} n_M \right)^2 \frac{J_L}{t_a} = \left(\frac{2\pi}{60} \times 3,000 \right)^2 \times \frac{2.29 \times 10^{-4}}{0.1} = 226 \text{ (W)}$$

8. Servomotor Provisional Selection**① Selection Conditions**

- $T_L \leq$ Motor rated torque
- $\frac{(P_O + P_a)}{2} <$ Provisionally selected Servomotor rated output $< (P_O + P_a)$
- $n_M \leq$ Rated motor speed
- $J_L \leq$ Allowable load moment of inertia

The following Servomotor meets the selection conditions.

- SGM7J-02A Servomotor

② Specifications of the Provisionally Selected Servomotor

Item	Value
Rated Output	200 (W)
Rated Motor Speed	3,000 (min ⁻¹)
Rated Torque	0.637 (N·m)
Instantaneous Maximum Torque	2.23 (N·m)
Motor Moment of Inertia	$0.263 \times 10^{-4} \text{ (kg}\cdot\text{m}^2\text{)}$
Allowable Load Moment of Inertia	$0.263 \times 10^{-4} \times 15 = 3.94 \times 10^{-4} \text{ (kg}\cdot\text{m}^2\text{)}$

9. Verification of the Provisionally Selected Servomotor

- Verification of required acceleration torque:

$$T_P = \frac{2\pi n_M (J_M + J_L)}{60 t_a} + T_L = \frac{2\pi \times 3,000 \times (0.263 + 2.29) \times 10^{-4}}{60 \times 0.1} + 0.43$$

$$\approx 1.23 \text{ (N}\cdot\text{m)} < \text{Maximum instantaneous torque...Satisfactory}$$
- Verification of required deceleration torque:

$$T_S = \frac{2\pi n_M (J_M + J_L)}{60 t_d} - T_L = \frac{2\pi \times 3,000 \times (0.263 + 2.29) \times 10^{-4}}{60 \times 0.1} - 0.43$$

$$\approx 0.37 \text{ (N}\cdot\text{m)} < \text{Maximum instantaneous torque...Satisfactory}$$

2.1 Selecting the Servomotor Capacity

2.1.2 Capacity Selection Example for a Rotary Servomotor: For Position Control

• Verification of effective torque value:

$$T_{rms} = \sqrt{\frac{T_P^2 \cdot ta + T_L^2 \cdot tc + T_s^2 \cdot td}{t}} = \sqrt{\frac{(1.23)^2 \times 0.1 + (0.43)^2 \times 1.0 + (0.37)^2 \times 0.1}{1.5}} \approx 0.483 \text{ (N}\cdot\text{m)} < \text{Rated torque...Satisfactory}$$

10. Result

It has been verified that the provisionally selected Servomotor is applicable. The torque diagram is shown below.

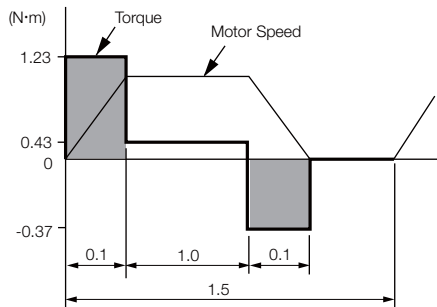

2.1.2 Capacity Selection Example for a Rotary Servomotor: For Position Control

1. Mechanical Specifications

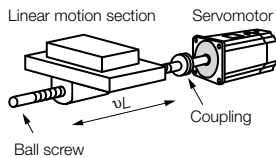

Item	Code	Value
Load Speed	v_L	15 m/min
Linear Motion Section Mass	m	80 kg
Ball Screw Length	ℓ_B	0.8 m
Ball Screw Diameter	d_B	0.016 m
Ball Screw Lead	P_B	0.005 m
Ball Screw Material Density	ρ	$7.87 \times 10^3 \text{ kg/m}^3$
External Force on Linear Motion Section	F	0 N
Coupling Mass	m_C	0.3 kg

Item	Code	Value
Coupling Outer Diameter	d_C	0.03 m
Number of Feeding Operations	n	40 rotation/min
Feeding Distance	ℓ	0.25 m
Feeding Time	tm	1.2 s max.
Electrical Stopping Precision	δ	$\pm 0.01 \text{ mm}$
Friction Coefficient	μ	0.2
Mechanical Efficiency	η	0.9 (90%)

2. Speed Diagram

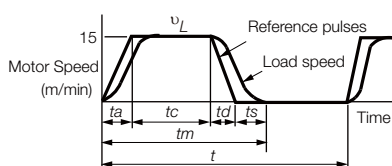

$$t = \frac{60}{n} = \frac{60}{40} = 1.5 \text{ (s)}$$

If $t_a = t_d$ and $t_s = 0.1 \text{ (s)}$,

$$t_a = tm - t_s - \frac{60 \ell}{v_L} = 1.2 - 0.1 - \frac{60 \times 0.25}{15} = 0.1 \text{ (s)}$$

$$t_c = 1.2 - 0.1 - 0.1 \times 2 = 0.9 \text{ (s)}$$

3. Motor Speed

- Load shaft speed $n_L = \frac{v_L}{P_B} = \frac{15}{0.005} = 3,000 \text{ (min}^{-1}\text{)}$
- Motor shaft speed Direct coupling gear ratio $1/R = 1/1$
Therefore, $n_M = n_L \cdot R = 3,000 \times 1 = 3,000 \text{ (min}^{-1}\text{)}$

4. Load Torque

$$T_L = \frac{(9.8 \mu \cdot m + F) \cdot P_B}{2\pi R \cdot \eta} = \frac{(9.8 \times 0.2 \times 80 + 0) \times 0.005}{2\pi \times 1 \times 0.9} = 0.139 \text{ (N}\cdot\text{m)}$$

5. Load Moment of Inertia

- Linear motion section

$$J_{L1} = m \left(\frac{P_B}{2\pi R} \right)^2 = 80 \times \left(\frac{0.005}{2\pi \times 1} \right)^2 = 0.507 \times 10^{-4} \text{ (kg}\cdot\text{m}^2\text{)}$$

- Ball screw $J_B = \frac{\pi}{32} \rho \cdot l_B \cdot d_B^4 = \frac{\pi}{32} \times 7.87 \times 10^3 \times 0.8 \times (0.016)^4 = 0.405 \times 10^{-4} \text{ (kg}\cdot\text{m}^2\text{)}$

- Coupling $J_C = \frac{1}{8} m_C \cdot d_C^2 = \frac{1}{8} \times 0.3 \times (0.03)^2 = 0.338 \times 10^{-4} \text{ (kg}\cdot\text{m}^2\text{)}$

- Load moment of inertia at motor shaft

$$J_L = J_{L1} + J_B + J_C = 1.25 \times 10^{-4} \text{ (kg}\cdot\text{m}^2\text{)}$$

6. Load Moving Power

$$P_O = \frac{2\pi n_M \cdot T_L}{60} = \frac{2\pi \times 3,000 \times 0.139}{60} = 43.7 \text{ (W)}$$

7. Load Acceleration Power

$$P_a = \left(\frac{2\pi}{60} n_M \right)^2 \frac{J_L}{t_a} = \left(\frac{2\pi}{60} \times 3,000 \right)^2 \times \frac{1.25 \times 10^{-4}}{0.1} = 123.4 \text{ (W)}$$

8. Servomotor Provisional Selection**① Selection Conditions**

- $T_L \leq$ Motor rated torque
- $\frac{(P_O + P_a)}{2} <$ Provisionally selected Servomotor rated output $< (P_O + P_a)$
- $n_M \leq$ Rated motor speed
- $J_L \leq$ Allowable load moment of inertia

The following Servomotor meets the selection conditions.

- SGM7J-01A Servomotor

② Specifications of the Provisionally Selected Servomotor

Item	Value
Rated Output	100 (W)
Rated Motor Speed	3,000 (min ⁻¹)
Rated Torque	0.318 (N·m)
Instantaneous Maximum Torque	1.11 (N·m)
Motor Moment of Inertia	0.0659 × 10 ⁻⁴ (kg·m ²)
Allowable Load Moment of Inertia	0.0659 × 10 ⁻⁴ × 35 = 2.31 × 10 ⁻⁴ (kg·m ²)
Encoder Resolution	16,777,216 (pulses/rev) (24 bits)

9. Verification of the Provisionally Selected Servomotor

- Verification of required acceleration torque:

$$T_P = \frac{2\pi n_M (J_M + J_L)}{60ta} + T_L = \frac{2\pi \times 3,000 \times (0.0659 + 1.25) \times 10^{-4}}{60 \times 0.1} + 0.139$$

$$\approx 0.552 \text{ (N}\cdot\text{m)} < \text{Maximum instantaneous torque...Satisfactory}$$
- Verification of required deceleration torque:

$$T_S = \frac{2\pi n_M (J_M + J_L)}{60td} - T_L = \frac{2\pi \times 3,000 \times (0.0659 + 1.25) \times 10^{-4}}{60 \times 0.1} - 0.139$$

$$\approx 0.274 \text{ (N}\cdot\text{m)} < \text{Maximum instantaneous torque...Satisfactory}$$
- Verification of effective torque value:

$$T_{rms} = \sqrt{\frac{T_P^2 \cdot ta + T_L^2 \cdot tc + T_S^2 \cdot td}{t}} = \sqrt{\frac{(0.552)^2 \times 0.1 + (0.139)^2 \times 0.9 + (0.274)^2 \times 0.1}{1.5}}$$

$$\approx 0.192 \text{ (N}\cdot\text{m)} < \text{Rated torque...Satisfactory}$$

It has been verified that the provisionally selected Servomotor is applicable in terms of capacity. Position control is considered next.

10. Positioning Resolution

The electrical stopping precision δ is ± 0.01 mm, so the positioning resolution Δ_ℓ is 0.01 mm. The ball screw lead P_B is 0.005 m, so the number of pulses per motor rotation is calculated with the following formula.

$$\text{Number of pulses per rotation (pulses)} = \frac{P_B}{\Delta_\ell} = \frac{5 \text{ mm/rev}}{0.01 \text{ mm}} = 500 \text{ (P/rev)} < \text{Encoder resolution (16,777,216 (pulses/rev))}$$

The number of pulses per motor rotation is less than the encoder resolution (pulses/rev), so the provisionally selected motor can be used.

11. Reference Pulse Frequency

The load speed v_L is 15 m/min, or $1,000 \times 15/60$ mm/s and the positioning resolution (travel distance per pulse) is 0.01 mm/pulse, so the reference pulse frequency is calculated with the following formula.

$$v_s = \frac{1,000 v_L}{60 \times \Delta_\ell} = \frac{1,000 \times 15}{60 \times 0.01} = 25,000 \text{ (pps)}$$

The reference pulse frequency is less than the maximum input pulse frequency,* so the provisionally selected Servomotor can be used.

*Refer to the specifications in the SERVOPACK manual for the maximum input pulse frequency.

It has been verified that the provisionally selected Servomotor is applicable for position control.

Specifications, Ratings, and External Dimensions of SGM7M Servomotors

3

This chapter describes how to interpret the model numbers of SGM7M Servomotors and gives their specifications, ratings, and external dimensions.

3.1	Model Designations	3-2
3.2	Specifications and Ratings	3-3
3.2.1	Specifications	3-3
3.2.2	Servomotor Ratings (SGM7M-□□E)	3-4
3.2.3	Torque-Motor Speed Characteristics (SGM7M-□□E)	3-5
3.2.4	Servomotor Overload Protection Characteristics (SGM7M-□□E)	3-5
3.2.5	Servomotor Ratings (SGM7M-□□A)	3-6
3.2.6	Torque-Motor Speed Characteristics (SGM7M-□□A)	3-7
3.2.7	Servomotor Overload Protection Characteristics (SGM7M-□□A)	3-7
3.2.8	Allowable Load Moment of Inertia	3-8
3.2.9	Derating Rates	3-9
3.3	External Dimensions	3-10
3.3.1	Servomotors without Holding Brakes	3-10
3.3.2	Servomotors with Holding Brakes	3-12

3.1 Model Designations

SGM7M - A1 A 3 A 2 1

Σ-V mini Series
Servomotors:
SGM7M

1st+2nd
digits

3rd
digit

4th
digit

5th
digit

6th
digit

7th
digit

1st+2nd digits Rated Output

Code	Specification
A1	11 W
A2	22 W
A3	33 W
B3	3.3 W
B5	5.5 W
B9	11 W

3rd digit Power Supply Voltage

Code	Specification
A	200 VAC
E	24 VDC/ 48 VDC*1, *2

4th digit Serial Encoder

Code	Specification
3	20-bit absolute

5th digit Design Revision Order

A

6th digit Shaft End

Code	Specification
2	Straight (standard)
A	Straight with flat seats (optional)

7th digit Options

Code	Specification
1	Without options
C	With holding brake (24 VDC)*3

*1. This specification must be used with SGD_V SERVOPACKs (Σ-V Series).

*2. Specifications are the same for 24 VDC and 48 VDC. Characteristics vary with the voltage of the main circuit for SERVOPACKs.

*3. Applicable only for SGM7M-A1/-A2/-A3.

3.2

Specifications and Ratings

3.2.1 Specifications

Voltage		24 VDC/48 VDC						200 VAC		
Model SGM7M-		B3E	B5E	B9E	A1E	A2E	A3E	A1A	A2A	A3A
Time Rating		Continuous								
Thermal Class		UL: A, CE: B					B			
Insulation Resistance		500 VDC, 10 M Ω min.								
Withstand Voltage		600 VAC for 1 minute						1,500 VAC for 1 minute		
Excitation		Permanent magnet								
Mounting		Flange-mounted								
Drive Method		Direct drive								
Rotation Direction		Counterclockwise (CCW) for forward reference when viewed from the load side								
Vibration Class* ¹		V15								
Environmental Conditions	Surrounding Air Temperature	0°C to 40°C								
	Surrounding Air Humidity	20% to 80% relative humidity (with no condensation)								
	Installation Site	<ul style="list-style-type: none"> • Must be indoors and free of corrosive and explosive gases. • Must be well-ventilated and free of dust and moisture. • Must facilitate inspection and cleaning. • Must have an altitude of 1,000 m or less. • Must be free of strong magnetic fields. 								
	Storage Environment	Store the Servomotor in the following environment if you store it with the power cable disconnected. Storage Temperature: -20°C to 60°C (with no freezing) Storage Humidity: 20% to 80% relative humidity (with no condensation)								
Shock Resistance* ²	Impact Acceleration Rate at Flange	490 m/s ²								
	Number of Impacts	2 times								
Vibration Resistance* ²	Vibration Acceleration Rate at Flange	49 m/s ²								
Applicable SERVOPACKS	SGDV- * ³	1R7E			2R9E			-	-	-
	SGD7S-	-	-	-	-	-	-	R90A, R90F		1R6A, 2R1F
	SGD7W-SGD7C-	-	-	-	-	-	-	1R6A* ⁴ , 2R8A* ⁴		1R6A, 2R8A* ⁴

*1. A vibration class of V15 indicates a vibration amplitude of 15 μ m maximum on the Servomotor without a load at the rated motor speed.

*2. The given values are for when the Servomotor shaft is mounted horizontally and shock or vibration is applied in the directions shown in the following figures.

The strength of the vibration that the Servomotor can withstand depends on the application. Always check the vibration acceleration rate that is applied to the Servomotor with the actual equipment.

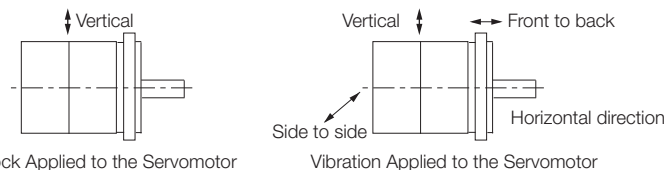

*3. These are Σ -V-series SERVOPACKS.

Refer to the following catalog for details.

AC Servo Drives Σ -V Series Product Catalog (Document No.: KAEP S800000 42)

*4. If you use a Servomotor together with a Σ -7W or Σ -7C SERVOPACK, the control gain may not increase as much as with a Σ -7S SERVOPACK and other performances may be lower than those achieved with a Σ -7S SERVOPACK.

3.2.2 Servomotor Ratings (SGM7M-□□E)

Voltage		24 VDC/48 VDC						
Model SGM7M		B3E	B5E	B9E	A1E	A2E	A3E	
Rated Output* ¹	W	3.3	5.5	11	11	22	33	
Rated Torque* ^{1, *2}	N·m	0.0105	0.0175	0.0350	0.0350	0.0700	0.105	
Instantaneous Maximum Torque* ¹	N·m	0.0263	0.0438	0.0875	0.105	0.210	0.306	
Rated Current* ¹	Arms	1.5	1.5	1.7	2.5	2.5	2.7	
Instantaneous Maximum Current* ¹	Arms	3.6	3.7	4.1	7.8	7.6	8.0	
Rated Motor Speed* ¹	min ⁻¹	3000						
Maximum Motor Speed* ¹	min ⁻¹	7000					6000	
Torque Constant	N·m/Arms	0.00814	0.0132	0.0241	0.0153	0.0309	0.0421	
Motor Moment of Inertia	×10 ⁻⁷ kg·m ²	0.560	0.902	2.29	2.54 (3.99)	4.49 (5.96)	6.81 (8.31)	
Rated Power Rate* ¹	kW/s	1.97	3.40	5.35	4.82	10.9	16.2	
Rated Angular Acceleration Rate* ¹	rad/s ²	188000	194000	153000	138000	156000	154000	
Motor Constant	N·m/√W	0.00374	0.00618	0.0133	0.0149	0.0244	0.0310	
Heat Sink Size (Aluminum)* ³	mm	150 × 150 × 3					250 × 250 × 6	
Protective Structure* ⁴		Totally enclosed, self-cooled, IP42 (except for shaft opening)			Totally enclosed, self-cooled, IP55 (except for shaft opening)			
Holding Brake Specifications* ⁵	Rated Voltage	V	–	–	–	DC24 V ±10%		
	Capacity	W	–	–	–	2.1	2.8	3.2
	Holding Torque	N·m	–	–	–	0.044	0.077	0.116
	Coil Resistance	Ω (at 20°C)	–	–	–	274.3	205.7	180
	Rated Current	A (at 20°C)	–	–	–	0.087	0.133	0.117
	Time Required to Release Brake	ms	–	–	–	60	60	60
	Time Required to Brake	ms	–	–	–	100	100	100
Allowable Load Moment of Inertia (Motor Moment of Inertia Ratio)* ⁶		30 times						
With External Regenerative Resistor		30 times						
Allowable Shaft Loads* ⁷	LF	mm	10			16		
	Allowable Radial Load	N	8	10	34	44		
	Allowable Thrust Load	N	4			14.5		

Note: The values in parentheses are for Servomotors with Holding Brakes.

*1. These values are for operation in combination with a SERVOPACK when the temperature of the armature winding is 100°C. The values for other items are at 20°C. These are typical values.

*2. The rated torques are the continuous allowable torque values at a surrounding air temperature of 40°C with an aluminum or steel heat sink of the dimensions given in the table.

*3. Refer to the following section for the relation between the heat sinks and derating rate.

 Servomotor Heat Dissipation Conditions on page 3-9

*4. This does not apply to the shaft opening. Protective structure specifications apply only when the special cable is used.

*5. Observe the following precautions if you use a Servomotor with a Holding Brake.

- The holding brake cannot be used to stop the Servomotor.
- The time required to release the brake and the time required to brake depend on which discharge circuit is used. Confirm that the operation delay time is appropriate for the actual equipment.
- The 24-VDC power supply is not provided by Yaskawa.

*6. The motor moment of inertia scaling factor is the value for a standard Servomotor without a Holding Brake.

*7. Design the mechanical system so that the thrust and radial loads applied to the Servomotor shaft end during operation do not exceed the values given in the table.

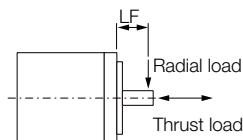

3.2.3 Torque-Motor Speed Characteristics (SGM7M-□□E)

A : Continuous duty zone — (solid lines): With 48 VDC input
B : Intermittent duty zone - - - (dotted lines): With 24 VDC input

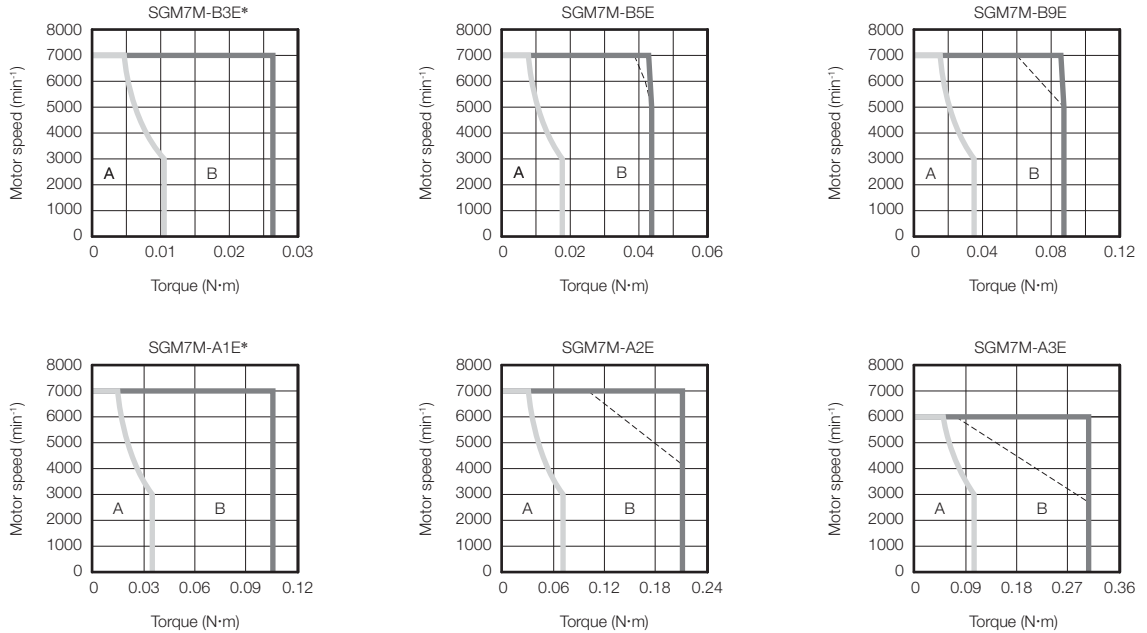

* The characteristics are the same for 24 VDC and 48 VDC input.

- Note: 1. These values (typical values) are for operation in combination with a SERVOPACK when the temperature of the armature winding is 100°C.
 2. The characteristics in the intermittent duty zone depend on the power supply voltage.
 3. If the effective torque is within the allowable range for the rated torque, the Servomotor can be used within the intermittent duty zone.
 4. If you use a Servomotor Main Circuit Cable that exceeds 20 m, the intermittent duty zone in the torque-motor speed characteristics will become smaller because the voltage drop increases.

3.2.4 Servomotor Overload Protection Characteristics (SGM7M-□□E)

The overload detection level is set for hot start conditions with a Servomotor surrounding air temperature of 40°C.

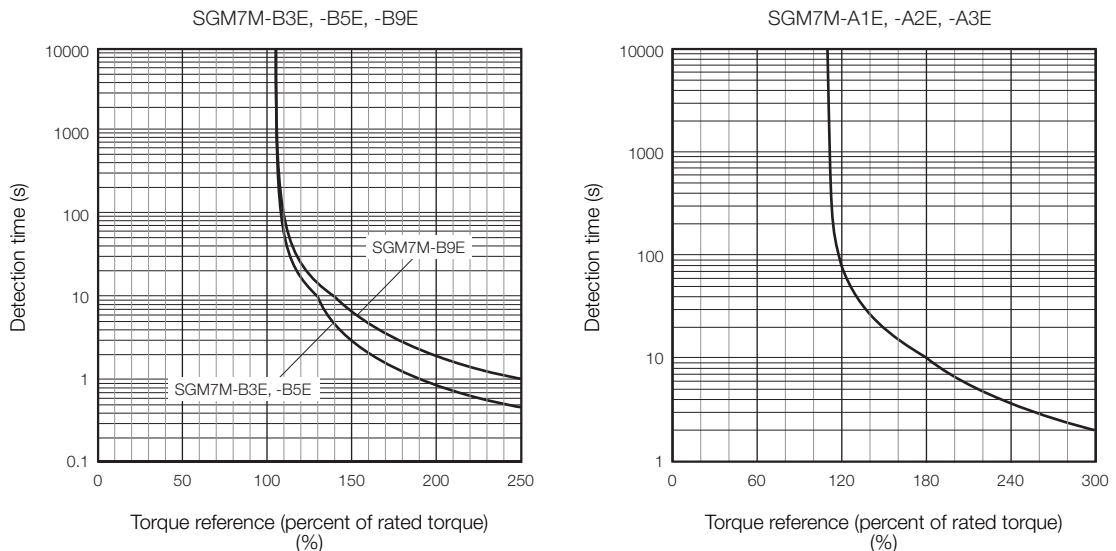

Note: The above overload protection characteristics do not mean that you can perform continuous duty operation with an output of 100% or higher. Use the Servomotor so that the effective torque remains within the continuous duty zone given in 3.2.3 Torque-Motor Speed Characteristics (SGM7M-□□E) on page 3-5.

3.2.5 Servomotor Ratings (SGM7M-□□A)

Voltage		200 VAC			
Model SGM7M-		A1A	A2A	A3A	
Rated Output* ¹	W	11	22	33	
Rated Torque* ^{1, *2}	N·m	0.0350	0.0700	0.105	
Instantaneous Maximum Torque* ¹	N·m	0.105	0.210	0.315	
Rated Current* ¹	Arms	0.83	0.82	0.90	
Instantaneous Maximum Current* ¹	Arms	2.6	2.5	2.8	
Rated Motor Speed* ¹	min ⁻¹	3000			
Maximum Motor Speed* ¹	min ⁻¹	7000			
Torque Constant	N·m/Arms	0.0458	0.0928	0.126	
Motor Moment of Inertia	×10 ⁻⁷ kg·m ²	2.54 (3.99)	4.49 (5.96)	6.81 (8.31)	
Rated Power Rate* ¹	kW/s	4.82	10.9	16.2	
Rated Angular Acceleration Rate* ¹	rad/s ²	138000	156000	154000	
Motor Constant	N·m/√W	0.0149	0.0245	0.0309	
Heat Sink Size (Aluminum)* ³	mm	150 × 150 × 3		250 × 250 × 6	
Protective Structure* ⁴	Totally enclosed, self-cooled, IP55 (except for shaft opening)				
Holding Brake Specifications* ⁵	Rated Voltage	V	DC24 V ±10%		
	Capacity	W	2.1	2.8	3.2
	Holding Torque	N·m	0.044	0.077	0.116
	Coil Resistance	Ω (at 20°C)	274.3	205.7	180
	Rated Current	A (at 20°C)	0.087	0.133	0.117
	Time Required to Release Brake	ms	60	60	60
	Time Required to Brake	ms	100	100	100
Allowable Load Moment of Inertia (Motor Moment of Inertia Ratio)* ⁶	30 times				
	With External Regenerative Resistor	30 times			
Allowable Shaft Loads* ⁷	LF	mm	16		
	Allowable Radial Load	N	34	44	
	Allowable Thrust Load	N	14.5		

Note: The values in parentheses are for Servomotors with Holding Brakes.

- *1. These values are for operation in combination with a SERVOPACK when the temperature of the armature winding is 100°C. The values for other items are at 20°C. These are typical values.
- *2. The rated torques are the continuous allowable torque values at a surrounding air temperature of 40°C with an aluminum or steel heat sink of the dimensions given in the table.
- *3. Refer to the following section for the relation between the heat sinks and derating rate.
 **Servomotor Heat Dissipation Conditions on page 3-9**
- *4. This does not apply to the shaft opening. Protective structure specifications apply only when the special cable is used.
- *5. Observe the following precautions if you use a Servomotor with a Holding Brake.
 - The holding brake cannot be used to stop the Servomotor.
 - The time required to release the brake and the time required to brake depend on which discharge circuit is used. Confirm that the operation delay time is appropriate for the actual equipment.
 - The 24-VDC power supply is not provided by Yaskawa.
- *6. The motor moment of inertia scaling factor is the value for a standard Servomotor without a Holding Brake.
- *7. Design the mechanical system so that the thrust and radial loads applied to the Servomotor shaft end during operation do not exceed the values given in the table.

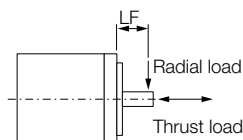

3.2.6 Torque-Motor Speed Characteristics (SGM7M-□□A)

- A : Continuous duty zone
- B : Intermittent duty zone*

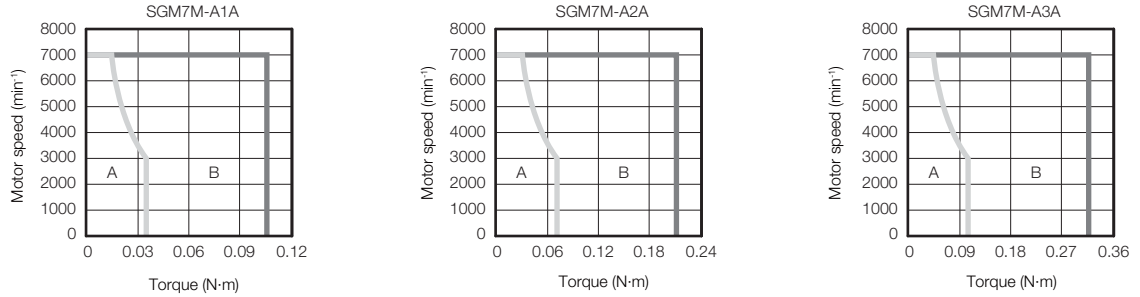

* The characteristics are the same for three-phase 200 V, single-phase 200 V, and single-phase 100 V input.

- Note:
1. These values (typical values) are for operation in combination with a SERVOPACK when the temperature of the armature winding is 100°C.
 2. The characteristics in the intermittent duty zone depend on the power supply voltage.
 3. If the effective torque is within the allowable range for the rated torque, the Servomotor can be used within the intermittent duty zone.
 4. If you use a Servomotor Main Circuit Cable that exceeds 20 m, the intermittent duty zone in the torque-motor speed characteristics will become smaller because the voltage drop increases.

3.2.7 Servomotor Overload Protection Characteristics (SGM7M-□□A)

The overload detection level is set for hot start conditions with a Servomotor surrounding air temperature of 40°C.

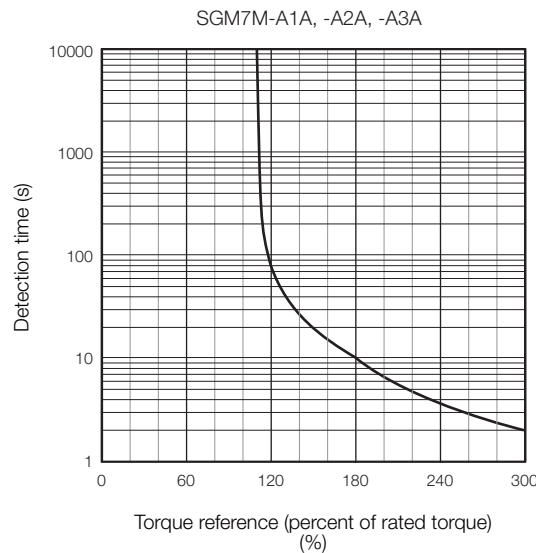

Note: The above overload protection characteristics do not mean that you can perform continuous duty operation with an output of 100% or higher. Use the Servomotor so that the effective torque remains within the continuous duty zone given in 3.2.6 Torque-Motor Speed Characteristics (SGM7M-□□A) on page 3-7.

3.2.8 Allowable Load Moment of Inertia

The allowable load moments of inertia (motor moment of inertia ratios) for the Servomotors are given in 3.2.2 *Servomotor Ratings (SGM7M-□□E)* on page 3-4 and 3.2.5 *Servomotor Ratings (SGM7M-□□A)* on page 3-6. The values are determined by the regenerative energy processing capacity of the SERVOPACK and are also affected by the drive conditions of the Servomotor. Perform the required Steps for each of the following cases.

Use the SigmaSize+ AC Servo Drive Capacity Selection Program to check the driving conditions. Contact your Yaskawa representative for information on this program.

Exceeding the Allowable Load Moment of Inertia

Use one of the following measures to adjust the load moment of inertia to within the allowable value.

- Reduce the torque limit.
- Reduce the deceleration rate.
- Reduce the maximum motor speed.

If the above steps is not possible, install an external regenerative resistor.

Information An Overvoltage Alarm (A.400) is likely to occur during deceleration if the load moment of inertia exceeds the allowable load moment of inertia. SERVOPACKs with a built-in regenerative resistor may generate a Regenerative Overload Alarm (A.320). Refer to the following catalog for the regenerative power (W) that can be processed by the SERVOPACKs.
 📖 AC Servo Drives Σ -7 Series Product Catalog (Document No.: KAEP S800001 23)
 Install an External Regenerative Resistor when the built-in regenerative resistor cannot process all of the regenerative power.

SERVOPACKs without Built-in Regenerative Resistors

The following graph shows the allowable load moment of inertia scaling factor of the motor speed (reference values for deceleration operation at or above the rated torque). Application is possible without an external regenerative resistor within the allowable value. However, an External Regenerative Resistor is required in the shaded areas of the graphs.

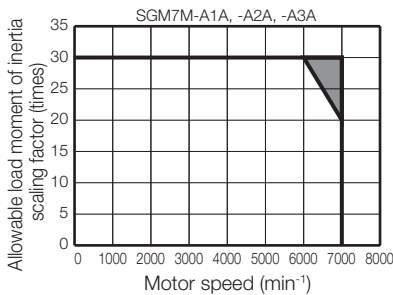

Note: Applicable SERVOPACK models: SGD7S-R90A, -1R6A, -R90F, and -2R1F

When an External Regenerative Resistor Is Required

Install the External Regenerative Resistor. Refer to the following catalog for the recommended products.

📖 AC Servo Drives Σ -7 Series Product Catalog (Document No.: KAEP S800001 23)

3.2.9 Derating Rates

Servomotor Heat Dissipation Conditions

The Servomotor ratings are the continuous allowable values when a heat sink is installed on the Servomotor. If the Servomotor is mounted on a small device component, the Servomotor temperature may rise considerably because the surface for heat dissipation becomes smaller. Refer to the following graphs for the relation between the heat sink size and derating rate.

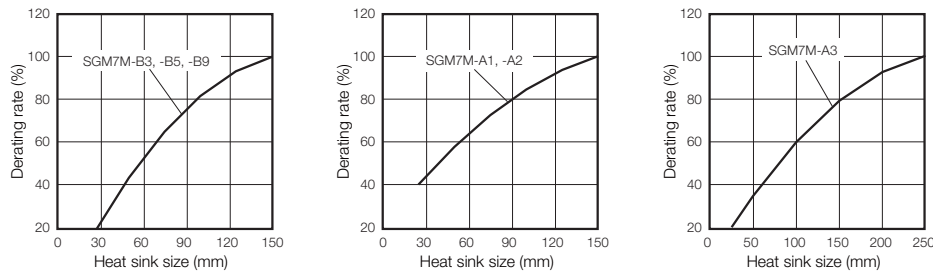

Important

The actual temperature rise depends on the following conditions. Always check the Servomotor temperature with the actual equipment.

- How the heat sink (the Servomotor mounting section) is attached to the installation surface
- Status between heat sink and Servomotor (sealant, reduction gear, etc.)
- What material is used for the Servomotor mounting section
- Servomotor speed

Information

When using Servomotors with derating, change the detection timing of overload warning and overload alarm based on the overload detection level of the motor given in 3.2.4 *Servomotor Overload Protection Characteristics (SGM7M-□□□)* on page 3-5 and 3.2.7 *Servomotor Overload Protection Characteristics (SGM7M-□□□A)* on page 3-7.

Note: The derating rates are applicable only when the average motor speed is less than or equal to the rated motor speed. If the average motor speed exceeds the rated motor speed, consult with your Yaskawa representative.

3.3 External Dimensions

3.3.1 Servomotors without Holding Brakes

SGM7M-B3, -B5 and -B9

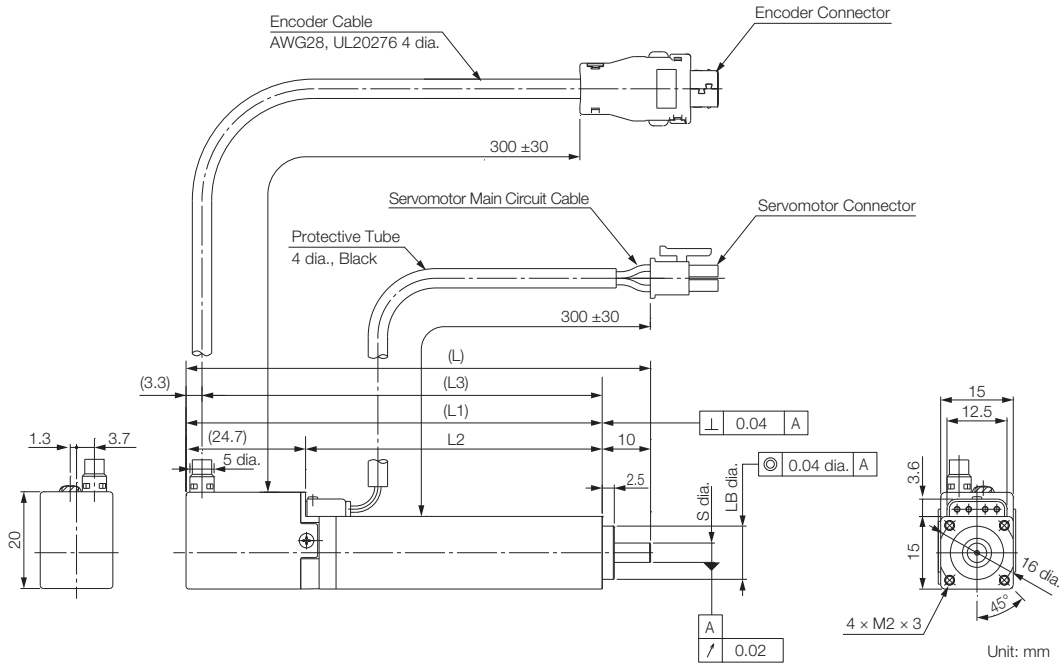

Model SGM7M-	L	L1	L2	L3	Flange Dimensions		Approx. Mass [g]
					S	LB	
B3E3A□1	56	46	21.3	42.7	4 ⁰ _{-0.008}	11 ⁰ _{-0.018}	55
B5E3A□1	62	52	27.3	48.7	4 ⁰ _{-0.008}	11 ⁰ _{-0.018}	60
B9E3A□1	96	86	61.3	82.7	4 ⁰ _{-0.008}	11 ⁰ _{-0.018}	100

◆ Shaft End Specification

- Straight with Flat Seats

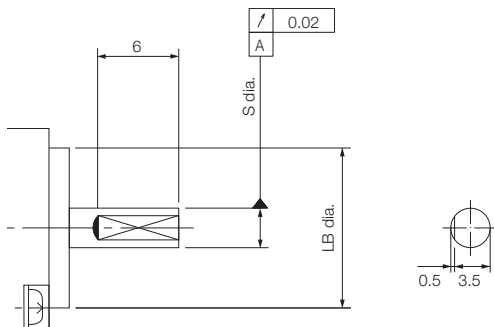

◆ Connector Specifications

- Encoder Connector

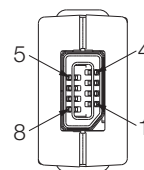

1	PG5V	5	PS
2	PG0V	6	/PS
3	BAT(+)	7	-
4	BAT(-)	8	-
Connector case			FG

Model: IX40-A-8S-CV (6.4)
 Manufacturer: Hirose Electric Co., Ltd.
 Mating connector: IX40-A-8P-CV

- Servomotor Connector

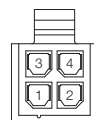

1	Phase U
2	Phase V
3	Phase W
4	FG (frame ground)

Receptacle: 43025-0400
 Manufacturer: Molex Japan LLC

SGM7M-A1, -A2 and -A3

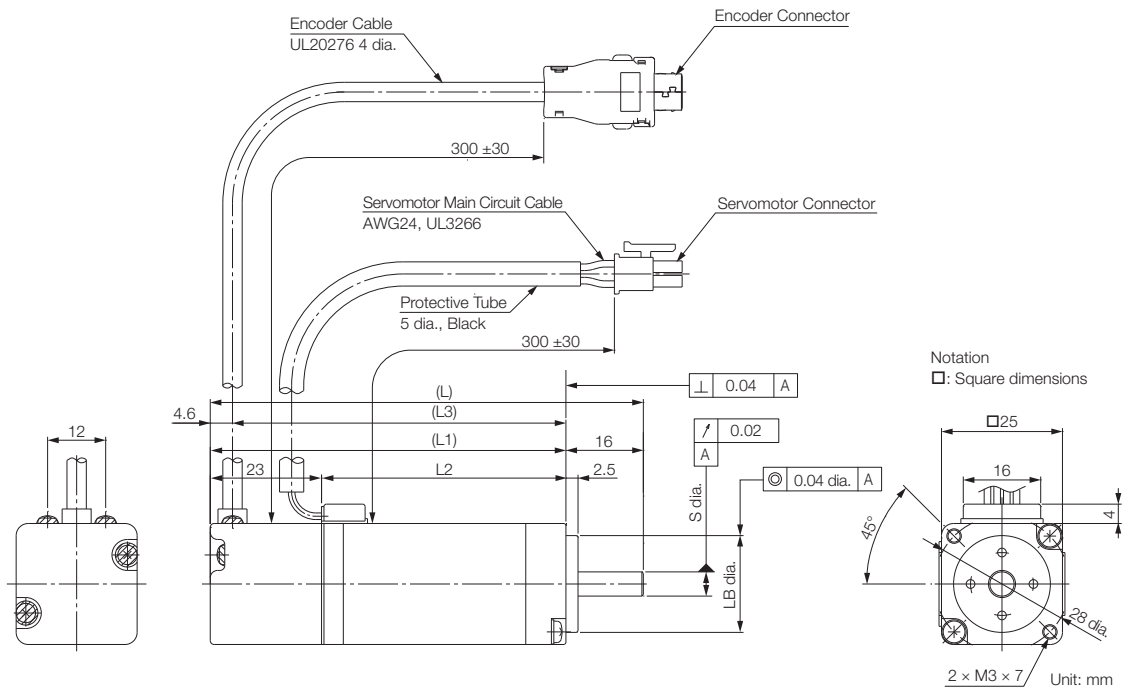

Model SGM7M-	L	L1	L2	L3	Flange Dimensions		Approx. Mass [g]
					S	LB	
A1□3A□1	68	52	29	47.4	5 ⁰ _{-0.008}	20 ⁰ _{-0.021}	120
A2□3A□1	78	62	39	57.4	5 ⁰ _{-0.008}	20 ⁰ _{-0.021}	160
A3□3A□1	89.5	73.5	50.5	68.9	5 ⁰ _{-0.008}	20 ⁰ _{-0.021}	210

◆ Shaft End Specification

- Straight with Flat Seats

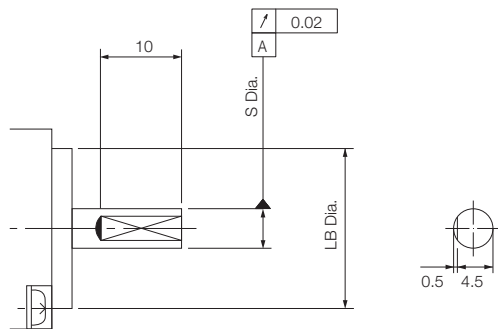

◆ Connector Specifications

- Encoder Connector

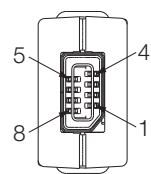

1	PG5V	5	PS
2	PG0V	6	/PS
3	BAT(+)	7	-
4	BAT(-)	8	-
Connector case			FG

Model: IX40-A-8S-CV (6.4)
 Manufacturer: Hirose Electric Co., Ltd.
 Mating connector: IX40-A-8P-CV

- Servomotor Connector

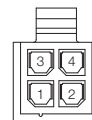

1	Phase U
2	Phase V
3	Phase W
4	FG (frame ground)

Receptacle: 43025-0400
 Manufacturer: Molex Japan LLC

3.3.2 Servomotors with Holding Brakes

SGM7M-A1, -A2 and -A3

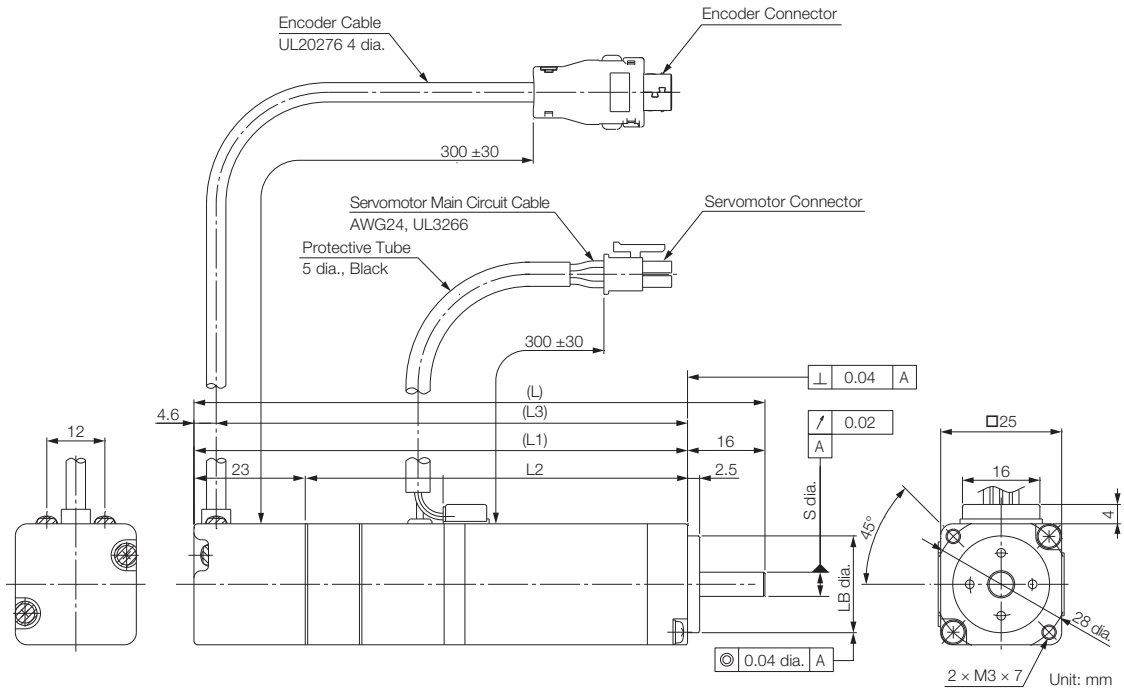

Model SGM7M-	L	L1	L2	L3	Flange Dimensions		Approx. Mass [g]
					S	LB	
A1□3A□C	90.5	74.5	29	69.9	5 ⁰ _{-0.008}	20 ⁰ _{-0.021}	180
A2□3A□C	104	88	39	83.4	5 ⁰ _{-0.008}	20 ⁰ _{-0.021}	220
A3□3A□C	118	102	50.5	97.4	5 ⁰ _{-0.008}	20 ⁰ _{-0.021}	310

◆ Shaft End Specification

- Straight with Flat Seats

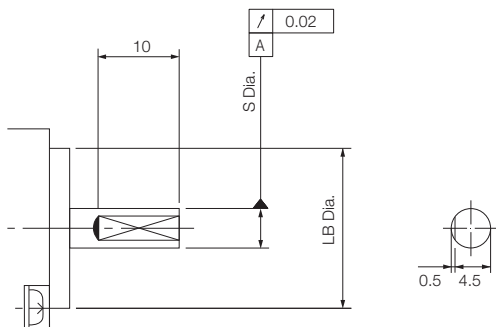

◆ Connector Specifications

- Encoder Connector

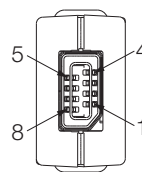

Pin	Signal	Pin	Signal
1	PG5V	5	PS
2	PG0V	6	/PS
3	BAT(+)	7	-
4	BAT(-)	8	-
Connector case			FG

Model: IX40-A-8S-CV (6.4)
 Manufacturer: Hirose Electric Co., Ltd.
 Mating connector: IX40-A-8P-CV

- Servomotor Connector

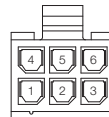

Pin	Signal
1	Phase U
2	Phase V
3	Phase W
4	FG (frame ground)
5	Brake
6	Brake

Receptacle: 43025-0600
 Manufacturer: Molex Japan LLC

Specifications, Ratings, and External Dimensions of SGM7J Servomotors

4

This chapter describes how to interpret the model numbers of SGM7J Servomotors and gives their specifications, ratings, and external dimensions.

4.1 Model Designations 4-2

- 4.1.1 Without Gears 4-2
- 4.1.2 With Gears 4-2

4.2 Specifications and Ratings 4-3

- 4.2.1 Specifications 4-3
- 4.2.2 Ratings of Servomotors without Gears 4-4
- 4.2.3 Torque-Motor Speed Characteristics 4-5
- 4.2.4 Ratings of Servomotors with Gears 4-6
- 4.2.5 Servomotor Overload Protection Characteristics . . . 4-8
- 4.2.6 Allowable Load Moment of Inertia 4-9
- 4.2.7 Derating Rates 4-10

4.3 External Dimensions 4-11

- 4.3.1 Servomotors without Gears 4-11
- 4.3.2 Servomotors with Gears 4-14

4.1 Model Designations

4.1.1 Without Gears

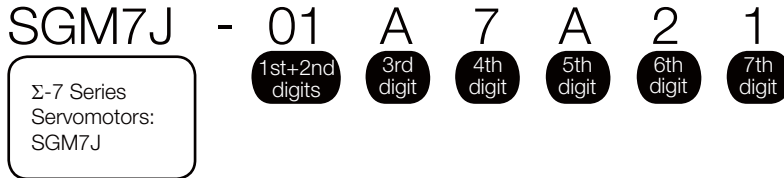

1st+2nd digits Rated Output

Code	Specification
A5	50 W
01	100 W
C2	150 W
02	200 W
04	400 W
06	600 W
08	750 W

3rd digit Power Supply Voltage

Code	Specification
A	200 VAC

4th digit Serial Encoder

Code	Specification
6	24-bit batteryless absolute
7	24-bit absolute
F	24-bit incremental

5th digit Design Revision Order

A

6th digit Shaft End

Code	Specification
2	Straight without key
6	Straight with key and tap
B	With two flat seats

7th digit Options

Code	Specification
1	Without options
C	With holding brake (24 VDC)
E	With oil seal and holding brake (24 VDC)
S	With oil seal

4.1.2 With Gears

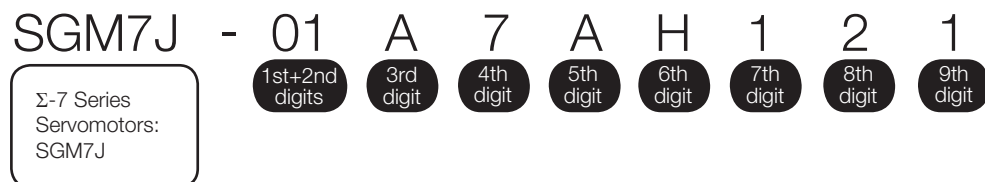

1st+2nd digits Rated Output

Code	Specification
A5	50 W
01	100 W
C2	150 W
02	200 W
04	400 W
06	600 W
08	750 W

3rd digit Power Supply Voltage

Code	Specification
A	200 VAC

4th digit Serial Encoder

Code	Specification
6	24-bit batteryless absolute
7	24-bit absolute
F	24-bit incremental

5th digit Design Revision Order

A

6th digit Gear Type

Code	Specification
H	HDS planetary low-backlash gear

7th digit Gear Ratio

Code	Specification
B	1/11 ^{*1}
C	1/21
1	1/5
2	1/9 ^{*2}
7	1/33

8th digit Shaft End

Code	Specification
0	Flange output
2	Straight without key
6	Straight with key and tap

9th digit Options

Code	Specification
1	Without options
C	With holding brake (24 VDC)

*1. This specification is not supported for models with a rated output of 50 W.

*2. This specification is supported only for models with a rated output of 50 W.

4.2 Specifications and Ratings

4.2.1 Specifications

Voltage		200 V						
Model SGM7J-		A5A	01A	C2A	02A	04A	06A	08A
Time Rating		Continuous						
Thermal Class		UL: B, CE: B						
Insulation Resistance		500 VDC, 10 M Ω min.						
Withstand Voltage		1,500 VAC for 1 minute						
Excitation		Permanent magnet						
Mounting		Flange-mounted						
Drive Method		Direct drive						
Rotation Direction		Counterclockwise (CCW) for forward reference when viewed from the load side						
Vibration Class* ¹		V15						
Environmental Conditions	Surrounding Air Temperature	0°C to 40°C (With derating, usage is possible between 40°C and 60°C.) ^{*3}						
	Surrounding Air Humidity	20% to 80% relative humidity (with no condensation)						
	Installation Site	<ul style="list-style-type: none"> • Must be indoors and free of corrosive and explosive gases. • Must be well-ventilated and free of dust and moisture. • Must facilitate inspection and cleaning. • Must have an altitude of 1,000 m or less. (With derating, usage is possible between 1,000 m and 2,000 m.)^{*3} • Must be free of strong magnetic fields. 						
	Storage Environment	Store the Servomotor in the following environment if you store it with the power cable disconnected. Storage temperature: -20°C to 60°C (with no freezing) Storage humidity: 20% to 80% relative humidity (with no condensation)						
Shock Resistance* ²	Impact Acceleration Rate at Flange	490 m/s ²						
	Number of Impacts	2 times						
Vibration Resistance* ²	Vibration Acceleration Rate at Flange	49 m/s ²						
Applicable SERVO-PACKs	SGD7S-	R70A, R70F	R90A, R90F	1R6A, 2R1F		2R8A, 2R8F	5R5A	
	SGD7W-SGD7C-	1R6A* ⁴ , 2R8A* ⁴		1R6A, 2R8A* ⁴		2R8A, 5R5A* ⁴ , 7R6A* ⁴	5R5A, 7R6A	

*1. A vibration class of V15 indicates a vibration amplitude of 15 μ m maximum on the Servomotor without a load at the rated motor speed.

*2. The given values are for when the Servomotor shaft is mounted horizontally and shock or vibration is applied in the directions shown in the following figures.

The strength of the vibration that the Servomotor can withstand depends on the application. Always check the vibration acceleration rate that is applied to the Servomotor with the actual equipment.

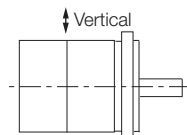

Shock Applied to the Servomotor

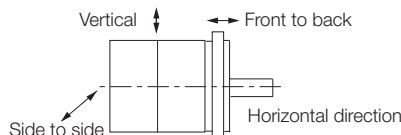

Vibration Applied to the Servomotor

*3. Refer to the following section for the derating rates.

 [4.2.7 Derating Rates on page 4-10](#)

*4. If you use the Servomotor together with a Σ -7W or Σ -7C SERVOPACK, the control gain may not increase as much as with a Σ -7S SERVOPACK and other performances may be lower than those achieved with a Σ -7S SERVOPACK.

4.2.2 Ratings of Servomotors without Gears

Voltage		200 V							
Model SGM7J-		A5A	01A	C2A	02A	04A	06A	08A	
Rated Output* ¹	W	50	100	150	200	400	600	750	
Rated Torque* ^{1, *2}	N·m	0.159	0.318	0.477	0.637	1.27	1.91	2.39	
Instantaneous Maximum Torque* ¹	N·m	0.557	1.11	1.67	2.23	4.46	6.69	8.36	
Rated Current* ¹	Arms	0.55	0.85	1.6	1.6	2.5	4.2	4.4	
Instantaneous Maximum Current* ¹	Arms	2.0	3.1	5.7	5.8	9.3	15.3	16.9	
Rated Motor Speed* ¹	min ⁻¹	3000							
Maximum Motor Speed* ¹	min ⁻¹	6000							
Torque Constant	N·m/Arms	0.316	0.413	0.321	0.444	0.544	0.493	0.584	
Motor Moment of Inertia	×10 ⁻⁴ kg·m ²	0.0395	0.0659	0.0915	0.263	0.486	0.800	1.59	
		With Holding Brake	0.0475	0.0739	0.0995	0.333	0.556	0.870	1.77
		With Batteryless Absolute Encoder	0.0410	0.0674	0.0930	0.264	0.487	0.801	1.59
Rated Power Rate* ¹	kW/s	6.40	15.3	24.8	15.4	33.1	45.6	35.9	
		With Holding Brake	5.32	13.6	22.8	12.1	29.0	41.9	32.2
Rated Angular Acceleration Rate* ¹	rad/s ²	40200	48200	52100	24200	26100	23800	15000	
		With Holding Brake	33400	43000	47900	19100	22800	21900	13500
Derating Rate for Servomotor with Oil Seal	%	80	90			95			
Heat Sink Size (Aluminum)* ³	mm	200 × 200 × 6			250 × 250 × 6				
Protective Structure* ⁴	Totally enclosed, self-cooled, IP67								
Holding Brake Specifications* ⁵	Rated Voltage	V	24 VDC ±10%						
	Capacity	W	5.5		6		6.5		
	Holding Torque	N·m	0.159	0.318	0.477	0.637	1.27	1.91	2.39
	Coil Resistance	Ω (at 20°C)	104.8 ±10%			96 ±10%		88.6 ±10%	
	Rated Current	A (at 20°C)	0.23			0.25		0.27	
	Time Required to Release Brake	ms	60					80	
	Time Required to Brake	ms	100						
Allowable Load Moment of Inertia (Motor Moment of Inertia Ratio)* ⁶			35 times		15 times	10 times	20 times	12 times	
	With External Regenerative Resistor and External Dynamic Brake Resistor* ⁷		35 times		25 times		20 times	15 times	
Allowable Shaft Loads* ⁸	LF	mm	20		25		35		
	Allowable Radial Load	N	78		245		392		
	Allowable Thrust Load	N	54		74		147		

*1. These values are for operation in combination with a SERVOPACK when the temperature of the armature winding is 100°C. The values for other items are at 20°C. These are typical values.

*2. The rated torques are the continuous allowable torque values at a surrounding air temperature of 40°C with an aluminum heat sink of the dimensions given in the table.

*3. Refer to the following section for the relation between the heat sinks and derating rate.

 **Servomotor Heat Dissipation Conditions** on page 4-10

*4. This does not apply to the shaft opening. Protective structure specifications apply only when the special cable is used.

*5. Observe the following precautions if you use a Servomotor with a Holding Brake.

- The holding brake cannot be used to stop the Servomotor.
- The time required to release the brake and the time required to brake depend on which discharge circuit is used. Confirm that the operation delay time is appropriate for the actual equipment.
- The 24-VDC power supply is not provided by Yaskawa.

- *6. The motor moment of inertia scaling factor is the value for a standard Servomotor without a Holding Brake.
- *7. To externally connect a dynamic brake resistor, select hardware option specification 020 for the SERVOPACK. However, you cannot externally connect a dynamic brake resistor if you use the following SERVOPACKS (maximum applicable motor capacity: 400 W).
 - SGD7S-R70□□□A020 to -2R8□□□A020
 - SGD7W-1R6A20A020 to -2R8A20A020
 - SGD7C-1R6AMAA020 to -2R8MAA020
- *8. Design the mechanical system so that the thrust and radial loads applied to the Servomotor shaft end during operation do not exceed the values given in the table.

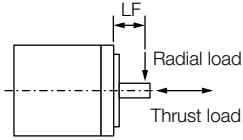

4.2.3 Torque-Motor Speed Characteristics

- A** : Continuous duty zone
- B** : Intermittent duty zone
- (solid lines): With three-phase 200-V or single-phase 230-V input
- (dotted lines): With single-phase 200-V input
- · - · (dashed-dotted lines): With single-phase 100-V input

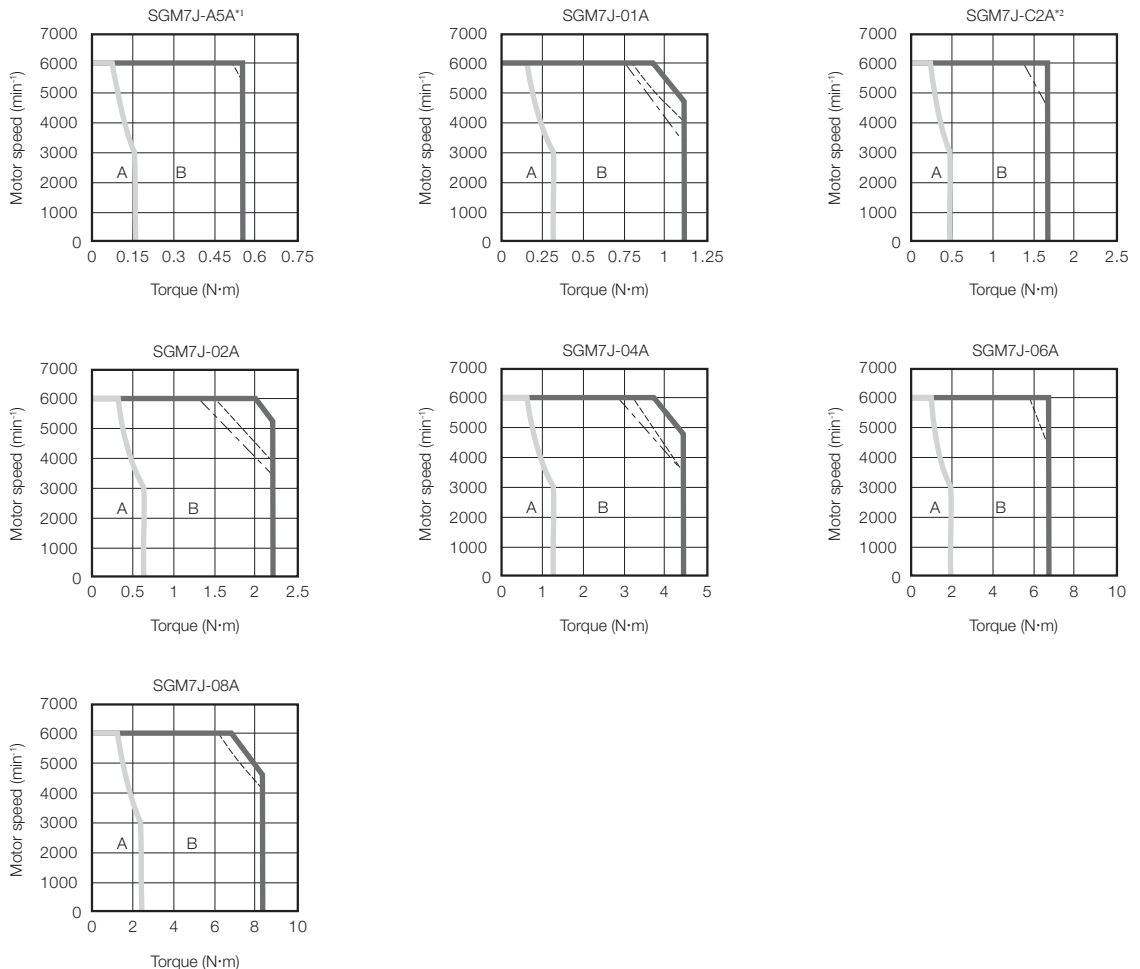

- *1. The characteristics are the same for a single-phase 200-V and single-phase 100-V input.
 - *2. The characteristics are the same for three-phase 200-V and single-phase 200-V input.
- Note: 1. These values (typical values) are for operation in combination with a SERVOPACK when the temperature of the armature winding is 100°C.
2. The characteristics in the intermittent duty zone depend on the power supply voltage.
 3. If the effective torque is within the allowable range for the rated torque, the Servomotor can be used within the intermittent duty zone.
 4. If you use a Servomotor Main Circuit Cable that exceeds 20 m, the intermittent duty zone in the torque-motor speed characteristics will become smaller because the voltage drop increases.

4.2.4 Ratings of Servomotors with Gears

All Models	Gear Mechanism	Protective Structure	Lost Motion [arc-min]
	Planetary gear mechanism	Totally enclosed, self-cooled, IP55 (except for shaft opening)	3 max.

Servomotor Model SGM7J-	Servomotor					Gear Output				
	Rated Output [W]	Rated Motor Speed [min ⁻¹]	Maximum Motor Speed [min ⁻¹]	Rated Torque [N·m]	Instantaneous Maximum Torque [N·m]	Gear Ratio	Rated Torque/Efficiency ^{*1} [N·m/%]	Instantaneous Maximum Torque [N·m]	Rated Motor Speed [min ⁻¹]	Maximum Motor Speed [min ⁻¹]
A5A□AH1□	50	3000	6000	0.159	0.557	1/5	0.433/64 ^{*2}	2.37	600	1200
A5A□AH2□						1/9	1.12/78	3.78 ^{*3}	333	667
A5A□AHC□						1/21	2.84/85	10.6	143	286
A5A□AH7□						1/33	3.68/70	15.8	91	182
01A□AH1□	100	3000	6000	0.318	1.11	1/5	1.06/78 ^{*2}	4.96	600	1200
01A□AHB□						1/11	2.52/72	10.7	273	545
01A□AHC□						1/21	5.35/80	20.8	143	286
01A□AH7□						1/33	7.35/70	32.7	91	182
C2A□AH1□	150	3000	6000	0.477	1.67	1/5	1.68/83 ^{*2}	7.80	600	1200
C2A□AHB□						1/11	3.53/79 ^{*2}	16.9	273	545
C2A□AHC□						1/21	6.30/70 ^{*2}	31.0	143	286
C2A□AH7□						1/33	11.2/79 ^{*2}	49.7	91	182
02A□AH1□	200	3000	6000	0.637	2.23	1/5	2.39/75	9.80	600	1200
02A□AHB□						1/11	5.74/82	22.1	273	545
02A□AHC□						1/21	10.2/76	42.1	143	286
02A□AH7□						1/33	17.0/81	67.6	91	182
04A□AH1□	400	3000	6000	1.27	4.46	1/5	5.35/84	20.1	600	1200
04A□AHB□						1/11	11.5/82	45.1	273	545
04A□AHC□						1/21	23.0/86	87.0	143	286
04A□AH7□						1/33	34.0/81	135	91	182
06A□AH1□	600	3000	6000	1.91	6.69	1/5	7.54/79	30.5	600	1200
06A□AHB□						1/11	18.1/86	68.6	273	545
06A□AHC□						1/21	32.1/80	129	143	286
06A□AH7□						1/33	53.6/85	206	91	182
08A□AH1□	750	3000	6000	2.39	8.36	1/5	10.0/84	38.4	600	1200
08A□AHB□						1/11	23.1/88	86.4	273	545
08A□AHC□						1/21	42.1/84	163	143	286
08A□AH7□						1/33	69.3/88	259	91	182

*1. The gear output torque is expressed by the following formula.

$$\text{Gear output torque} = \text{Servomotor output torque} \times \frac{1}{\text{Gear ratio}} \times \text{Efficiency}$$

The gear efficiency depends on operating conditions such as the output torque, motor speed, and temperature. The values in the table are typical values for the rated torque, rated motor speed, and a surrounding air temperature of 25°C. They are reference values only.

*2. When using an SGM7J-A5A, SGM7J-01A, or SGM7J-C2A Servomotor with a gear ratio of 1/5 or an SGM7J-C2A Servomotor with a gear ratio of 1/11, maintain an 85% maximum effective load ratio. For an SGM7J-C2A Servomotor with a gear ratio of 1/21 or 1/33, maintain a 90% maximum effective load ratio. The values in the table take the effective load ratio into consideration.

*3. The instantaneous maximum torque is 300% of the rated torque.

Note: 1. The gears that are mounted to Yaskawa Servomotors have not been broken in.

Break in the Servomotor if necessary. First, operate the Servomotor at low speed with no load. If no problems occur, gradually increase the speed and load.

2. The no-load torque for a Servomotor with a Gear is high immediately after the Servomotor starts, and it then decreases and becomes stable after a few minutes.

This is a common phenomenon caused by grease circulation in the gears and it does not indicate faulty gears.

3. Other specifications are the same as those for Servomotors without Gears.



The SERVOPACK speed control range is 1:5,000. If you use Servomotors at extremely low speeds (0.02 min⁻¹ or lower at the gear output shaft), if you use Servomotors with a one-pulse feed reference for extended periods, or under some other operating conditions, the gear bearing lubrication may be insufficient. That may cause deterioration of the bearing or increase the load ratio. Contact your Yaskawa representative if you use a Servomotor under these conditions.

Servomotor Model SGM7J-	Moment of Inertia [$\times 10^{-4}$ kg·m ²]				With Gears			Reference Diagram
	Shaft Output		Flange Output		Allowable Radial Load [N]	Allowable Thrust Load [N]	LF [mm]	
	Motor* + Gear	Gear	Motor* + Gear	Gear				
A5A□AH1□	0.0455	0.006	0.0445	0.005	95	431	37	
A5A□AH2□	0.0425	0.003	0.0425	0.003	113	514	37	
A5A□AHC□	0.0435	0.004	0.0435	0.004	146	663	37	
A5A□AH7□	0.0845	0.045	0.0845	0.045	267	1246	53	
01A□AH1□	0.0719	0.006	0.0709	0.005	95	431	37	
01A□AHB□	0.126	0.060	0.125	0.059	192	895	53	
01A□AHC□	0.116	0.050	0.116	0.050	233	1087	53	
01A□AH7□	0.131	0.065	0.130	0.064	605	2581	75	
C2A□AH1□	0.0975	0.006	0.0965	0.005	95	431	37	
C2A□AHB□	0.152	0.060	0.151	0.059	192	895	53	
C2A□AHC□	0.202	0.110	0.200	0.108	528	2254	75	
C2A□AH7□	0.157	0.065	0.156	0.064	605	2581	75	
02A□AH1□	0.470	0.207	0.464	0.201	152	707	53	
02A□AHB□	0.456	0.193	0.455	0.192	192	895	53	
02A□AHC□	0.753	0.490	0.751	0.488	528	2254	75	
02A□AH7□	0.713	0.450	0.712	0.449	605	2581	75	
04A□AH1□	0.693	0.207	0.687	0.201	152	707	53	
04A□AHB□	1.06	0.570	1.05	0.560	435	1856	75	
04A□AHC□	0.976	0.490	0.974	0.488	528	2254	75	
04A□AH7□	1.11	0.620	1.10	0.610	951	4992	128	
06A□AH1□	1.50	0.700	1.46	0.660	343	1465	75	
06A□AHB□	1.37	0.570	1.36	0.560	435	1856	75	
06A□AHC□	1.64	0.840	1.62	0.820	830	4359	128	
06A□AH7□	1.42	0.620	1.41	0.610	951	4992	128	
08A□AH1□	2.29	0.700	2.25	0.660	343	1465	75	
08A□AHB□	2.19	0.600	2.18	0.590	435	1856	75	
08A□AHC□	4.59	3.00	4.57	2.98	830	4359	128	
08A□AH7□	4.39	2.80	4.37	2.78	951	4992	128	

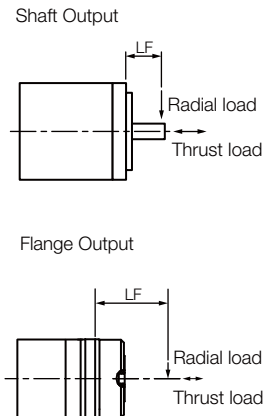

* The moment of inertia for the Servomotor and gear is the value without a holding brake. You can calculate the moment of inertia for a Servomotor with a Gear and Holding Brake with the following formula.

Motor moment of inertia for a Servomotor with a Holding Brake from 4.2.2 Ratings of Servomotors without Gears on page 4-4 + Moment of inertia for the gear from the above table.

4.2 Specifications and Ratings

4.2.5 Servomotor Overload Protection Characteristics



Important

During operation, the gear generates the loss at the gear mechanism and oil seal. The loss depends on the torque and motor speed conditions. The temperature rise depends on the loss and heat dissipation conditions. For the heat dissipation conditions, always refer to the following table and check the gear and motor temperatures with the actual equipment. If the temperature is too high, implement the following measures.

- Decrease the load ratio.
- Change the heat dissipation conditions.
- Use forced-air cooling for the motor with a cooling fan or other means.

Model	Heat Sink Size			
	1/5	1/9 or 1/11	1/21	1/33
SGM7J-A5	A			
SGM7J-01	A			1/33
SGM7J-C2	B			
SGM7J-02	B		1/33	
SGM7J-04	B		1/33	
SGM7J-06	C		1/33	
SGM7J-08	C		1/33	

- A: 250 mm × 250 mm × 6 mm, aluminum plate
- B: 300 mm × 300 mm × 12 mm, aluminum plate
- C: 350 mm × 350 mm × 12 mm, aluminum plate

4.2.5 Servomotor Overload Protection Characteristics

The overload detection level is set for hot start conditions with a Servomotor surrounding air temperature of 40°C.

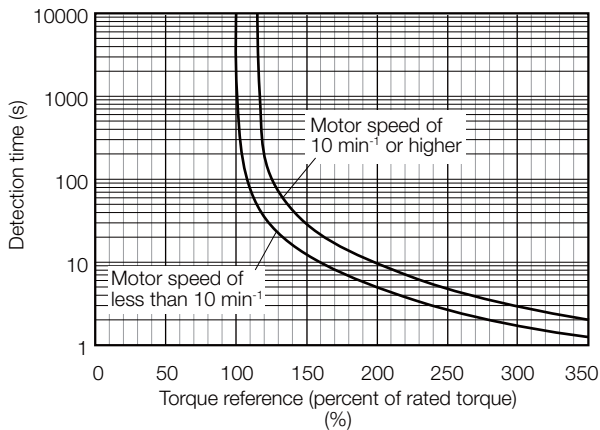

Note: The above overload protection characteristics do not mean that you can perform continuous duty operation with an output of 100% or higher. Use the Servomotor so that the effective torque remains within the continuous duty zone given in 4.2.3 *Torque-Motor Speed Characteristics* on page 4-5.

4.2.6 Allowable Load Moment of Inertia

The allowable load moments of inertia (motor moment of inertia ratios) for the Servomotors are given in the *4.2.2 Ratings of Servomotors without Gears* on page 4-4. The values are determined by the regenerative energy processing capacity of the SERVOPACK and are also affected by the drive conditions of the Servomotor. Perform the required Steps for each of the following cases.

Use the SigmaSize+ AC Servo Drive Capacity Selection Program to check the driving conditions. Contact your Yaskawa representative for information on this program.

Exceeding the Allowable Load Moment of Inertia

Use one of the following measures to adjust the load moment of inertia to within the allowable value.

- Reduce the torque limit.
- Reduce the deceleration rate.
- Reduce the maximum motor speed.

If the above steps is not possible, install an external regenerative resistor.

Information

An Overvoltage Alarm (A.400) is likely to occur during deceleration if the load moment of inertia exceeds the allowable load moment of inertia. SERVOPACKs with a built-in regenerative resistor may generate a Regenerative Overload Alarm (A.320). Refer to the following catalog for the regenerative power (W) that can be processed by the SERVOPACKs.

📖 AC Servo Drives Σ -7 Series Product Catalog (Document No.: KAEP S800001 23)

Install an External Regenerative Resistor when the built-in regenerative resistor cannot process all of the regenerative power.

SERVOPACKs without Built-in Regenerative Resistors

The following graph shows the allowable load moment of inertia scaling factor of the motor speed (reference values for deceleration operation at or above the rated torque). Application is possible without an external regenerative resistor within the allowable value. However, an External Regenerative Resistor is required in the shaded areas of the graphs.

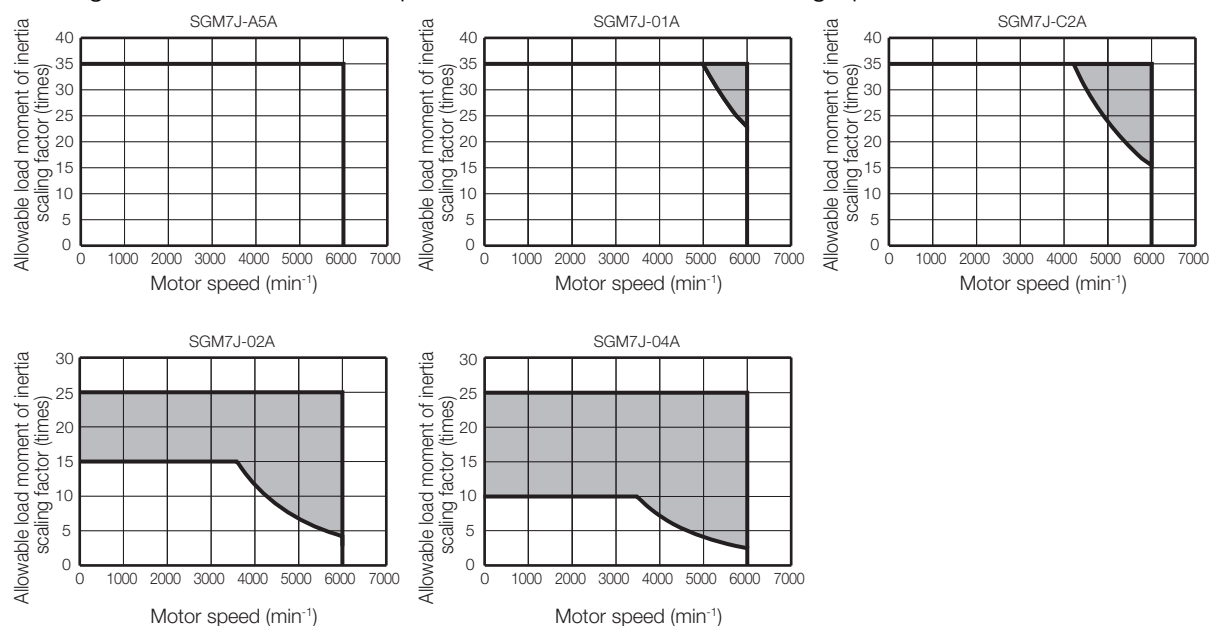

Note: Applicable SERVOPACK models: SGD7S-R70A, -R90A, -1R6A, -2R8A, -R70F, -R90F, -2R1F, and -2R8F

When an External Regenerative Resistor Is Required

Install the External Regenerative Resistor. Refer to the following catalog for the recommended products.

📖 AC Servo Drives Σ -7 Series Product Catalog (Document No.: KAEP S800001 23)

4.2.7 Derating Rates

Servomotor Heat Dissipation Conditions

The Servomotor ratings are the continuous allowable values at a surrounding air temperature of 40°C when a heat sink is installed on the Servomotor. If the Servomotor is mounted on a small device component, the Servomotor temperature may rise considerably because the surface for heat dissipation becomes smaller. Refer to the following graphs for the relation between the heat sink size and derating rate.

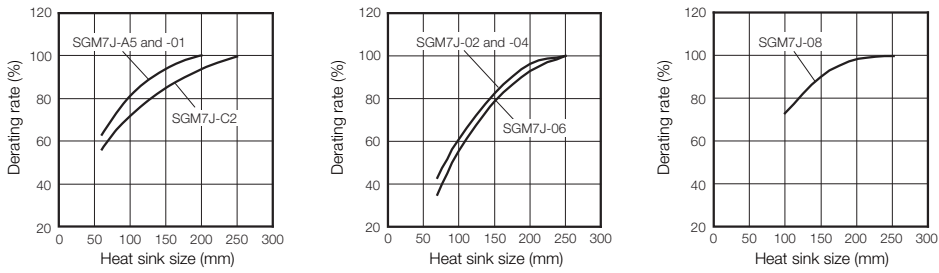

Important The actual temperature rise depends on the following conditions. Always check the Servomotor temperature with the actual equipment.

- How the heat sink (the Servomotor mounting section) is attached to the installation surface
- Status between heat sink and Servomotor (sealant, reduction gear, etc.)
- What material is used for the Servomotor mounting section
- Servomotor speed

Applications Where the Surrounding Air Temperature Exceeds 40°C

The Servomotor ratings are the continuous allowable values at a surrounding air temperature of 40°C. If you use a Servomotor at a surrounding air temperature that exceeds 40°C (60°C max.), apply a suitable derating rate from the following graphs.

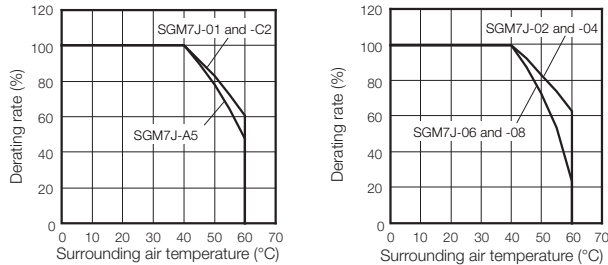

Applications Where the Altitude Exceeds 1,000 m

The Servomotor ratings are the continuous allowable values at an altitude of 1,000 m or less. If you use a Servomotor at an altitude that exceeds 1,000 m (2,000 m max.), the heat dissipation effect of the air is reduced. Apply the appropriate derating rate from the following graphs.

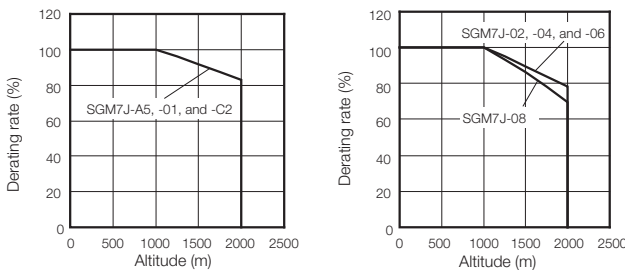

Information When using Servomotors with derating, change the detection timing of overload warning and overload alarm based on the overload detection level of the motor given in 4.2.5 *Servomotor Overload Protection Characteristics* on page 4-8.

Note: 1. Use the combination of the SERVOPACK and Servomotor so that the derating conditions are satisfied for both the SERVOPACK and Servomotor.
 2. The derating rates are applicable only when the average motor speed is less than or equal to the rated motor speed. If the average motor speed exceeds the rated motor speed, consult with your Yaskawa representative.

4.3 External Dimensions

4.3.1 Servomotors without Gears

SGM7J-A5, -01, and -C2

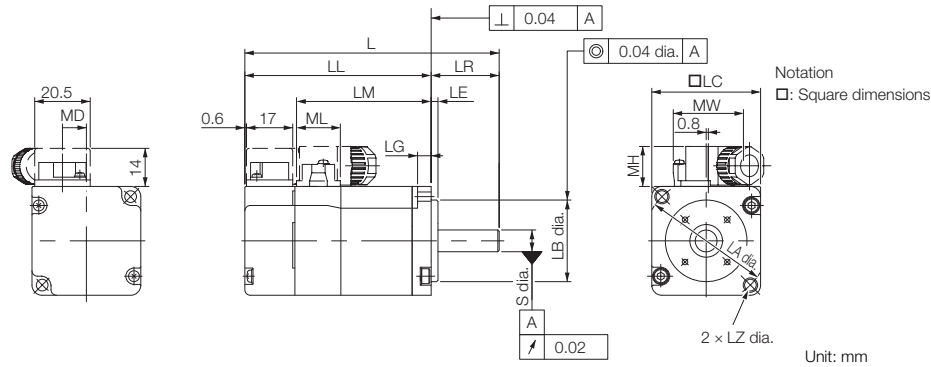

Model SGM7J-	L*	LL*	LM	Flange Dimensions							S	MD	MW	MH	ML	Approx. Mass [kg]
				LR	LE	LG	LC	LA	LB	LZ						
A5A□A2□	81.5 (122)	56.5 (97)	37.9	25	2.5	5	40	46	30 ⁰ _{-0.021}	4.3	8 ⁰ _{-0.009}	8.8	25.8	14.7	16.1	0.3 (0.6)
01A□A2□	93.5 (134)	68.5 (109)	49.9	25	2.5	5	40	46	30 ⁰ _{-0.021}	4.3	8 ⁰ _{-0.009}	8.8	25.8	14.7	16.1	0.4 (0.7)
C2A□A2□	105.5 (153.5)	80.5 (128.5)	61.9	25	2.5	5	40	46	30 ⁰ _{-0.021}	4.3	8 ⁰ _{-0.009}	8.8	25.8	14.7	16.1	0.5 (0.8)

* For models that have a batteryless absolute encoder, L and LL are 8 mm greater than the given value. Refer to the following section for the values for individual models.

🔗 *Dimensions of Servomotors with Batteryless Absolute Encoders on page 4-20*

Note: 1. The values in parentheses are for Servomotors with Holding Brakes.

2. The values for a straight, without key specification are given. Refer to the information given below for other shaft end specifications and option specifications.

◆ Shaft End Specifications

- Straight with Key and Tap

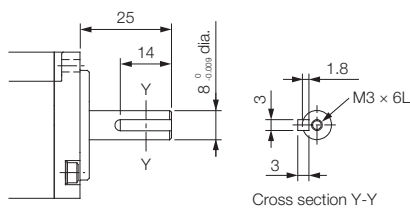

- With Two Flat Seats

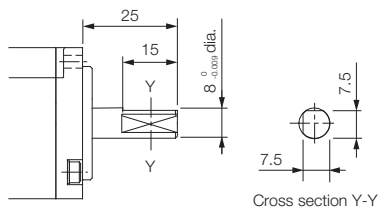

◆ Specifications of Options

- Oil Seal

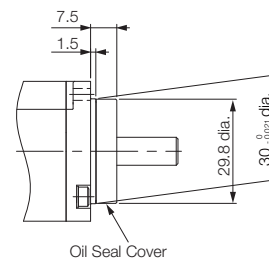

◆ Connector Mounting Dimensions

- Cable Installed on Load Side

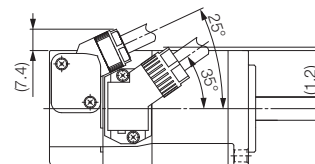

- Cable Installed on Non-load Side

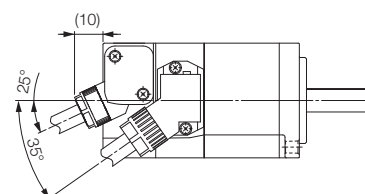

SGM7J-02, -04, and -06

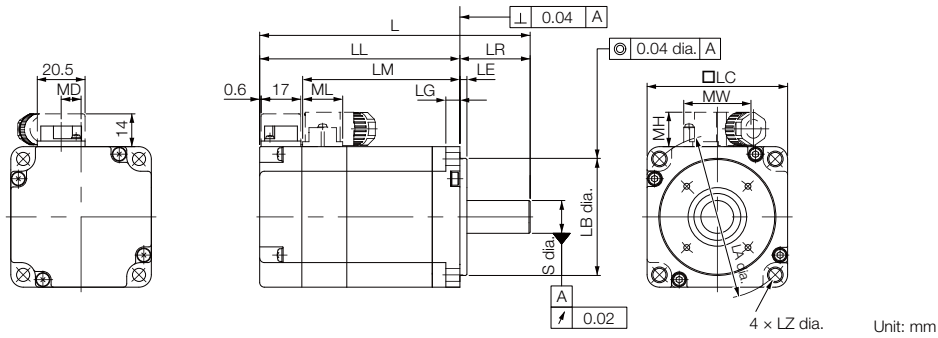

Model SGM7J-	L*	LL*	LM	Flange Dimensions							S	MD	MW	MH	ML	Approx. Mass [kg]
				LR	LE	LG	LC	LA	LB	LZ						
02A□A2□	99.5 (140)	69.5 (110)	51.2	30	3	6	60	70	50 ⁰ _{-0.025}	5.5	14 ⁰ _{-0.011}	8.5	28.7	14.7	17.1	0.8 (1.4)
04A□A2□	115.5 (156)	85.5 (126)	67.2	30	3	6	60	70	50 ⁰ _{-0.025}	5.5	14 ⁰ _{-0.011}	8.5	28.7	14.7	17.1	1.1 (1.7)
06A□A2□	137.5 (191.5)	107.5 (161.5)	89.2	30	3	6	60	70	50 ⁰ _{-0.025}	5.5	14 ⁰ _{-0.011}	8.5	28.7	14.7	17.1	1.6 (2.2)

* For models that have a batteryless absolute encoder, L and LL are 8 mm greater than the given value. Refer to the following section for the values for individual models.

Dimensions of Servomotors with Batteryless Absolute Encoders on page 4-20

Note: 1. The values in parentheses are for Servomotors with Holding Brakes.

2. The values for a straight, without key specification are given. Refer to the information given below for other shaft end specifications and option specifications.

◆ Shaft End Specifications

- Straight with Key and Tap

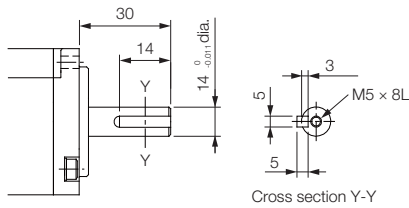

- With Two Flat Seats

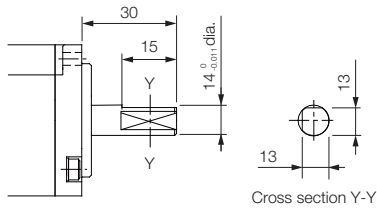

◆ Specifications of Options

- Oil Seal

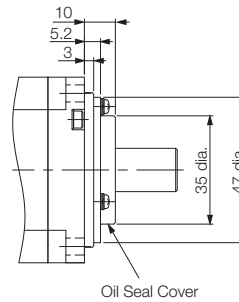

◆ Connector Mounting Dimensions

- Cable Installed on Load Side

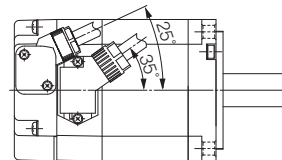

- Cable Installed on Non-load Side

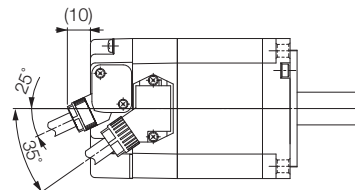

SGM7J-08

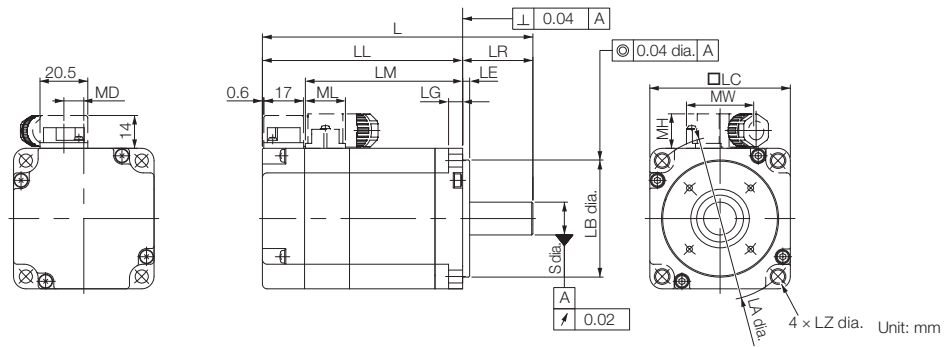

Model SGM7J-	L*	LL*	LM	Flange Dimensions							S	MD	MW	MH	ML	Approx. Mass* [kg]
				LR	LE	LG	LC	LA	LB	LZ						
08A□A2□	137 (184)	97 (144)	78.5	40	3	8	80	90	70 ⁰ _{-0.030}	7	19 ⁰ _{-0.013}	13.6	38	14.7	19.3	2.2 (2.8)

* For models that have a batteryless absolute encoder, L and LL are 8 mm greater and the approximate mass is 0.1 kg greater than the given value. Refer to the following section for the values for individual models.

Dimensions of Servomotors with Batteryless Absolute Encoders on page 4-20

Note: 1. The values in parentheses are for Servomotors with Holding Brakes.

2. The values for a straight, without key specification are given. Refer to the information given below for other shaft end specifications and option specifications.

◆ Shaft End Specifications

- Straight with Key and Tap

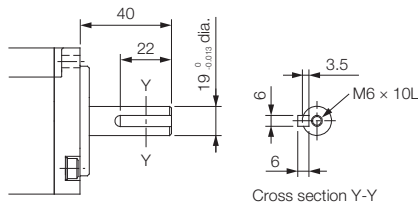

- With Two Flat Seats

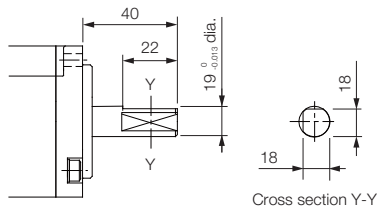

◆ Specifications of Options

- Oil Seal

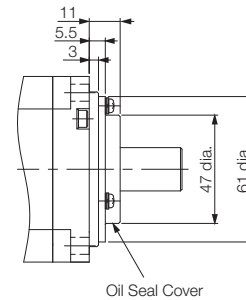

◆ Connector Mounting Dimensions

- Cable Installed on Load Side

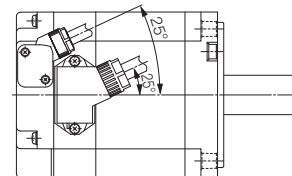

- Cable Installed on Non-load Side

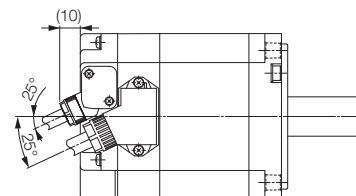

4.3.2 Servomotors with Gears

SGM7J-A5, -01, and -C2

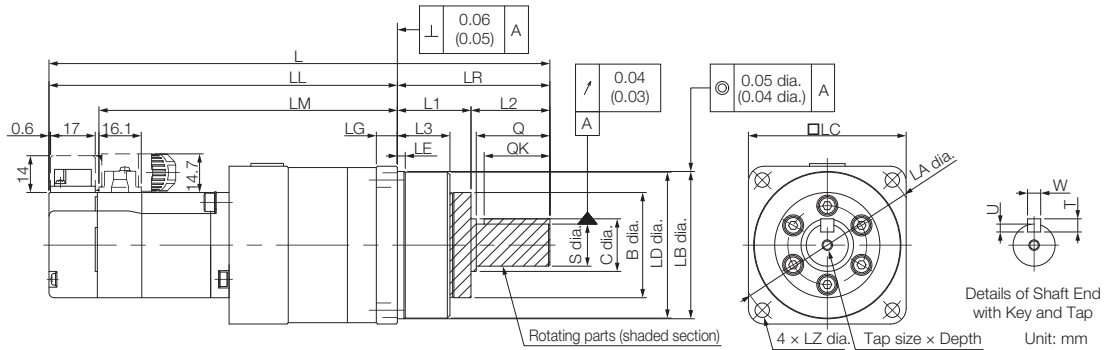

Model SGM7J-	Gear Ratio	L*	LL*	LM	Flange Dimensions								
					LR	LE	LG	B	LD	LB	LC	LA	LZ
A5A□AH1□□	1/5	138	96	77.4	42	2.2	5	29	39.5	40 ⁰ _{-0.025}	40	46	3.4
A5A□AH2□□	1/9	(178.5)	(136.5)										
A5A□AHC□□	1/21	147	105	86.4	58	2.5	8	40	55.5	56 ⁰ _{-0.030}	60	70	5.5
A5A□AH7□□	1/33	178.5	120.5	(219)									
01A□AH1□□	1/5	150	108	89.4	42	2.2	5	29	39.5	40 ⁰ _{-0.025}	40	46	3.4
01A□AHB□□	1/11	190.5	132.5	(231)									
01A□AHC□□	1/21	215	135	113.9	80	7.5	10	59	84	85 ⁰ _{-0.035}	90	105	9
01A□AH7□□	1/33	(255.5)	(175.5)										
C2A□AH1□□	1/5	162	120	101.4	42	2.2	5	29	39.5	40 ⁰ _{-0.025}	40	46	3.4
C2A□AHB□□	1/11	202.5	144.5	(250.5)									
C2A□AHC□□	1/21	227	147	128.4	80	7.5	10	59	84	85 ⁰ _{-0.035}	90	105	9
C2A□AH7□□	1/33	(275)	(195)										

Model SGM7J-	Flange Dimensions			Q	C	S	Tap Size x Depth	Key Dimensions				Approx. Mass [kg]
	L1	L2	L3					QK	U	W	T	
A5A□AH1□□	22	20	14.6	-	-	10 ⁰ _{-0.015}	M3 x 6L	15	2.5	4	4	0.6
A5A□AH2□□												0.7
A5A□AHC□□												1.0
A5A□AH7□□	28	30	20	28	20	16 ⁰ _{-0.018}	M4 x 8L	25	3	5	5	1.3
01A□AH1□□	22	20	14.6	-	-	10 ⁰ _{-0.015}	M3 x 6L	15	2.5	4	4	0.7
01A□AHB□□	28	30	20	28	20	16 ⁰ _{-0.018}	M4 x 8L	25	3	5	5	1.4
01A□AHC□□												1.7
01A□AH7□□	36	44	26	42	32	25 ⁰ _{-0.021}	M6 x 12L	36	4	8	7	2.8
C2A□AH1□□	22	20	14.6	-	-	10 ⁰ _{-0.015}	M3 x 6L	15	2.5	4	4	0.8
C2A□AHB□□	28	30	20	28	20	16 ⁰ _{-0.018}	M4 x 8L	25	3	5	5	1.5
C2A□AHC□□	36	44	26	42	32	25 ⁰ _{-0.021}	M6 x 12L	36	4	8	7	2.9
C2A□AH7□□												3.2

* For models that have a batteryless absolute encoder, L and LL are 8 mm greater than the given value. Refer to the following section for the values for individual models.

Dimensions of Servomotors with Batteryless Absolute Encoders on page 4-20

- Note: 1. The values in parentheses are for Servomotors with Holding Brakes.
 2. Gear dimensions are different from those of the Σ, Σ-II, and Σ-III Series.
 3. The values for the shaft end are for a straight shaft with key and tap. If a key and tap are not necessary, specify shaft end code 2 for the 8th digit.

◆ Flange Output Face

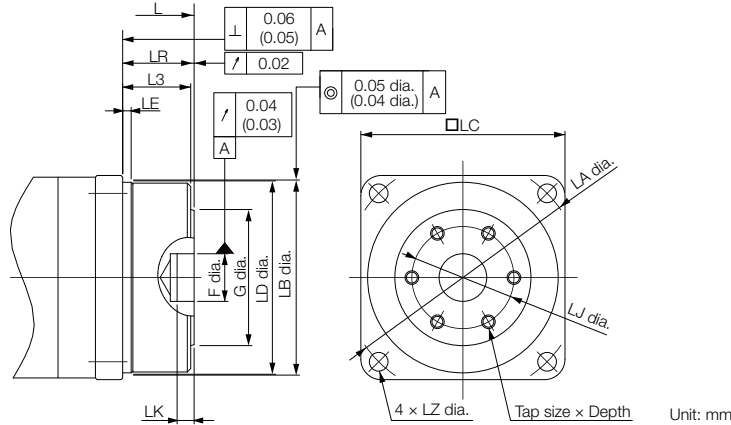

Note: The geometric tolerance in parentheses is the value for LC = 40.

Model SGM7J-	Gear Ratio	L*	LR	LJ	F	G	LK	No. of Taps × Tap Size × Depth	Approx. Mass [kg]
A5A□AH10□	1/5	111	15	18	5 ^{+0.012} ₀	24	3	3 × M4 × 6L	0.6 (0.9)
A5A□AH20□	1/9	(151.5)							
A5A□AHC0□	1/21	120 (160.5)							
A5A□AH70□	1/33	141.5 (182)	21	30	14 ^{+0.018} ₀	40	5	6 × M4 × 7L	1.2 (1.5)
01A□AH10□	1/5	123 (163.5)	15	18	5 ^{+0.012} ₀	24	5	3 × M4 × 6L	0.7 (1.0)
01A□AHB0□	1/11	153.5 (194)	21	30	14 ^{+0.018} ₀	40		3 × M4 × 7L	1.3 (1.6)
01A□AHC0□	1/21							6 × M6 × 10L	2.4 (2.7)
01A□AH70□	1/33	162 (202.5)	27	45	24 ^{+0.021} ₀	59	5		
C2A□AH10□	1/5	135 (183)	15	18	5 ^{+0.012} ₀	24	3	3 × M4 × 6L	0.8 (1.1)
C2A□AHB0□	1/11	165.5 (213.5)	21	30	14 ^{+0.018} ₀	40	5	6 × M4 × 7L	1.4 (1.7)
C2A□AHC0□	1/21	174	27	45	24 ^{+0.021} ₀	59	5	6 × M6 × 10L	2.5 (2.8)
C2A□AH70□	1/33	(222)							

* For models that have a batteryless absolute encoder, L is 8 mm greater than the given value. Refer to the following section for the values for individual models.

📖 **Dimensions of Servomotors with Batteryless Absolute Encoders on page 4-20**

- Note: 1. The values in parentheses are for Servomotors with Holding Brakes.
 2. Dimensions not found in the above table are the same as those in the table on the previous page.

Important For a Servomotor with a flange output that has square gear flange dimensions (□LC) of 40 mm, we recommend that you design the Servomotor with the dimensions shown in the following figure in order to secure a gap between the gear oil seal and the connecting parts on the load side.

SGM7J-02, -04, and -06

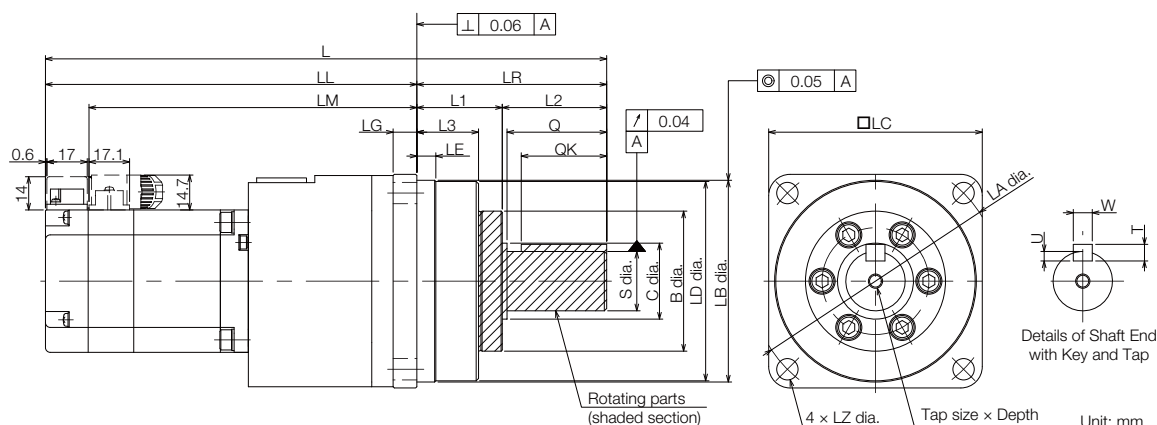

Model SGM7J-	Gear Ratio	L*	LL*	LM	Flange Dimensions								
					LR	LE	LG	B	LD	LB	LC	LA	LZ
02A□AH1□□	1/5	191.5	133.5	115.2	58	2.5	8	40	55.5	56 ⁰ _{-0.030}	60	70	5.5
02A□AHB□□	1/11	(232)	(174)										
02A□AHC□□	1/21	220.5	140.5	122.2	80	7.5	10	59	84	85 ⁰ _{-0.035}	90	105	9
02A□AH7□□	1/33	(261)	(181)										
04A□AH1□□	1/5	207.5	149.5	131.2	58	2.5	8	40	55.5	56 ⁰ _{-0.030}	60	70	5.5
04A□AHB□□	1/11	(248)	(190)										
04A□AHC□□	1/21	236.5	156.5	138.2	80	7.5	10	59	84	85 ⁰ _{-0.035}	90	105	9
04A□AH7□□	1/33	(277)	(197)										
06A□AH1□□	1/5	322.5	189.5	171.2	133	12.5	13	84	114	115 ⁰ _{-0.035}	120	135	11
06A□AH7□□	1/33	(363)	(230)										
06A□AHB□□	1/11	258.5	178.5	160.2	80	7.5	10	59	84	85 ⁰ _{-0.035}	90	105	9
06A□AHC□□	1/21	(312.5)	(232.5)										
06A□AH7□□	1/33	344.5	211.5	193.2	133	12.5	13	84	114	115 ⁰ _{-0.035}	120	135	11
06A□AH7□□	1/33	(398.5)	(265.5)										

Model SGM7J-	Flange Dimensions			Q	C	S	Tap Size × Depth	Key Dimensions				Approx. Mass [kg]
	L1	L2	L3					QK	U	W	T	
02A□AH1□□	28	30	20	28	20	16 ⁰ _{-0.018}	M4 × 8L	25	3	5	5	1.8 (2.4)
02A□AHB□□												1.9 (2.5)
02A□AHC□□	36	44	26	42	32	25 ⁰ _{-0.021}	M6 × 12L	36	4	8	7	3.7 (4.3)
02A□AH7□□												3.7 (4.3)
04A□AH1□□	28	30	20	28	20	16 ⁰ _{-0.018}	M4 × 8L	25	3	5	5	2.1 (2.7)
04A□AHB□□												4.0 (4.6)
04A□AHC□□	36	44	26	42	32	25 ⁰ _{-0.021}	M6 × 12L	36	4	8	7	4.0 (4.6)
04A□AH7□□												8.6 (9.2)
06A□AH1□□	36	44	26	42	32	25 ⁰ _{-0.021}	M6 × 12L	36	4	8	7	4.3 (4.9)
06A□AHB□□												4.5 (5.1)
06A□AHC□□	48	85	33	82	44	40 ⁰ _{-0.025}	M10 × 20L	70	5	12	8	9.1 (9.7)
06A□AH7□□												9.1 (9.7)

* For models that have a batteryless absolute encoder, L and LL are 8 mm greater than the given value. Refer to the following section for the values for individual models.

Dimensions of Servomotors with Batteryless Absolute Encoders on page 4-20

- Note: 1. The values in parentheses are for Servomotors with Holding Brakes.
 2. Gear dimensions are different from those of the Σ, Σ-II, and Σ-III Series.
 3. The values for the shaft end are for a straight shaft with key and tap. If a key and tap are not necessary, specify shaft end code 2 for the 8th digit.

◆ Flange Output Face

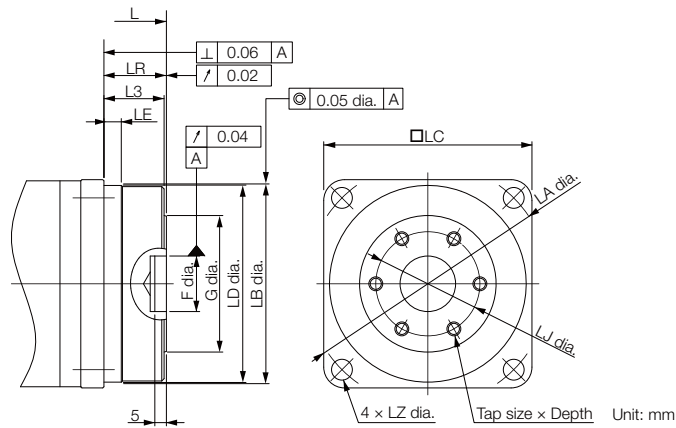

Model SGM7J-	Gear Ratio	L*	LR	LJ	F	G	No. of Taps × Tap Size × Depth	Approx. Mass [kg]
02A□AH10□	1/5	154.5 (195)	21	30	14 ^{+0.018} ₀	40	6 × M4 × 7L	1.7 (2.3)
02A□AHB0□	1/11							1.8 (2.4)
02A□AHC0□	1/21	167.5 (208)	27	45	24 ^{+0.021} ₀	59	6 × M6 × 10L	3.3 (3.9)
02A□AH70□	1/33							
04A□AH10□	1/5	170.5 (211)	21	30	14 ^{+0.018} ₀	40	6 × M4 × 7L	2.0 (2.6)
04A□AHB0□	1/11	183.5 (224)	27	45	24 ^{+0.021} ₀	59	6 × M6 × 10L	3.6 (4.2)
04A□AHC0□	1/21							
04A□AH70□	1/33	224.5 (265)	35	60	32 ^{+0.025} ₀	84	6 × M8 × 12L	7.2 (7.8)
06A□AH10□	1/5	205.5 (259.5)	27	45	24 ^{+0.021} ₀	59	6 × M6 × 10L	3.9 (4.5)
06A□AHB0□	1/11							4.1 (4.7)
06A□AHC0□	1/21	246.5 (300.5)	35	60	32 ^{+0.025} ₀	84	6 × M8 × 12L	7.7 (8.3)
06A□AH70□	1/33							

* For models that have a batteryless absolute encoder, L is 8 mm greater than the given value. Refer to the following section for the values for individual models.

 **Dimensions of Servomotors with Batteryless Absolute Encoders on page 4-20**

Note: 1. The values in parentheses are for Servomotors with Holding Brakes.

2. Dimensions not found in the above table are the same as those in the table on the previous page.

4.3 External Dimensions

4.3.2 Servomotors with Gears

SGM7J-08

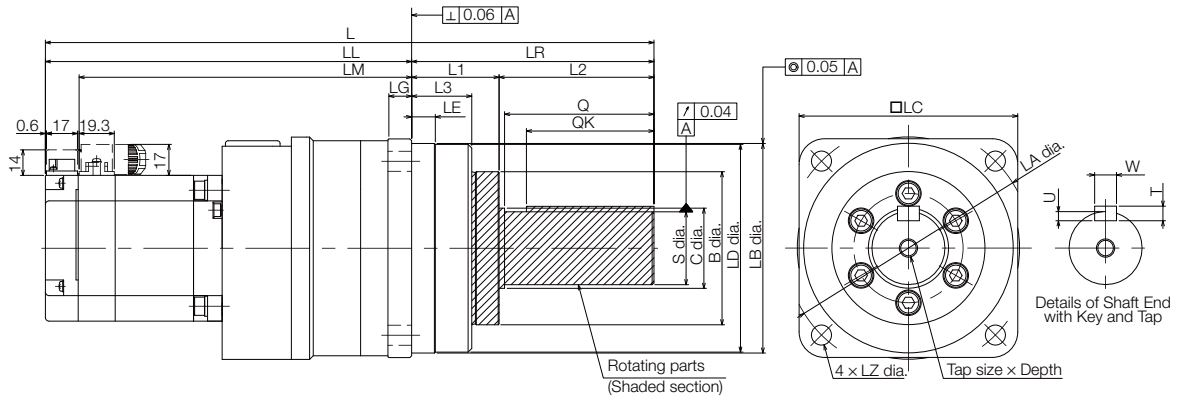

Unit: mm

Model SGM7J-	Gear Ratio	L*	LL*	LM	Flange Dimensions								
					LR	LE	LG	B	LD	LB	LC	LA	LZ
08A□AH1□□	1/5	255	175	156.5	80	7.5	10	59	84	85 ⁰ _{-0.035}	90	105	9
08A□AHB□□	1/11	(302)	(222)										
08A□AHC□□	1/21	334	201	182.5	133	12.5	13	84	114	115 ⁰ _{-0.035}	120	135	11
08A□AH7□□	1/33	(381)	(248)										

Model SGM7J-	Flange Dimensions			Q	C	S	Tap Size × Depth	Key Dimensions				Approx. Mass* [kg]
	L1	L2	L3					QK	U	W	T	
08A□AH1□□	36	44	26	42	32	25 ⁰ _{-0.021}	M6 × 12L	36	4	8	7	5.1 (5.7)
08A□AHB□□												5.3 (5.9)
08A□AHC□□	48	85	33	82	44	40 ⁰ _{-0.025}	M10 × 20L	70	5	12	8	10 (10.6)
08A□AH7□□												

* For models that have a batteryless absolute encoder, L and LL are 8 mm greater and the approximate mass is 0.1 kg greater than the given value. Refer to the following section for the values for individual models.

 Dimensions of Servomotors with Batteryless Absolute Encoders on page 4-20

- Note: 1. The values in parentheses are for Servomotors with Holding Brakes.
 2. Gear dimensions are different from those of the Σ, Σ-II, and Σ-III Series.
 3. The values for the shaft end are for a straight shaft with key and tap. If a key and tap are not necessary, specify shaft end code 2 for the 8th digit.

◆ Flange Output Face

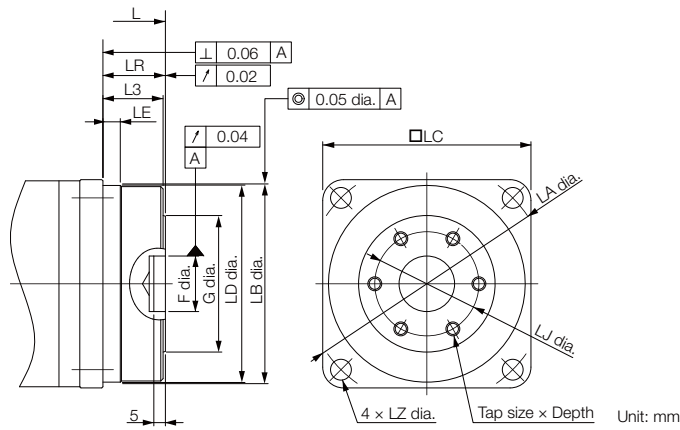

Model SGM7J-	Gear Ratio	L*	LR	LJ	F	G	No. of Taps × Tap Size × Depth	Approx. Mass* [kg]
08A□AH101	1/5	202 (249)	27	45	24 ^{+0.021} ₀	59	6 × M6 × 10L	4.7 (5.3)
08A□AHB01	1/11							4.9 (5.5)
08A□AHC01	1/21	236 (283)	35	60	32 ^{+0.025} ₀	84	6 × M8 × 12L	8.6 (9.2)
08A□AH701	1/33							

* For models that have a batteryless absolute encoder, L is 8 mm greater and the approximate mass is 0.1 kg greater than the given value. Refer to the following section for the values for individual models.

 Dimensions of Servomotors with Batteryless Absolute Encoders on page 4-20

Note: 1. The values in parentheses are for Servomotors with Holding Brakes.

2. Dimensions not found in the above table are the same as those in the table on the previous page.

Dimensions of Servomotors with Batteryless Absolute Encoders

◆ Servomotors without Gears

Model SGM7J-	L	LL	Approx. Mass [kg]
A5A6A2□	89.5 (130)	64.5 (105)	0.3 (0.6)
01A6A2□	101.5 (142)	76.5 (117)	0.4 (0.7)
C2A6A2□	113.5 (161.5)	88.5 (136.5)	0.5 (0.8)
02A6A2□	107.5 (148)	77.5 (118)	0.8 (1.4)
04A6A2□	123.5 (164)	93.5 (134)	1.1 (1.7)
06A6A2□	145.5 (199.5)	115.5 (169.5)	1.6 (2.2)
08A6A2□	145 (192)	105 (152)	2.3 (2.9)

Note: The values in parentheses are for Servomotors with Holding Brakes.

◆ Servomotors with Gears

• Shaft End Specification: Straight

Model SGM7J-	L	LL	Approx. Mass [kg]
A5A6AH1□□	146	104	0.6
A5A6AH2□□	(186.5)	(144.5)	(0.9)
A5A6AHC□□	155	113	0.7
	(195.5)	(153.5)	(1.7)
A5A6AH7□□	186.5	128.5	1.3
	(227)	(169)	(1.6)
01A6AH1□□	158	116	0.7
	(198.5)	(156.5)	(1.0)
01A6AHB□□	198.5	140.5	1.4
01A6AHC□□	(239)	(181)	(1.7)
01A6AH7□□	223	143	2.8
	(263.5)	(183.5)	(3.1)
C2A6AH1□□	170	128	0.8
	(218)	(176)	(1.1)
C2A6AHB□□	210.5	152.5	1.5
	(258.5)	(200.5)	(1.8)
C2A6AHC□□	235	155	2.9
C2A6AH7□□	(283)	(203)	(3.2)
02A6AH1□□	199.5	141.5	1.8
	(240)	(182)	(2.4)
02A6AHB□□			1.9
			(2.5)
02A6AHC□□	228.5	148.5	3.7
02A6AH7□□	(269)	(189)	(4.3)
04A6AH1□□	215.5	157.5	2.1
	(256)	(198)	(2.7)
04A6AHB□□	244.5	164.5	4.0
04A6AHC□□	(285)	(205)	(4.6)
04A6AH7□□	330.5	197.5	8.6
	(371)	(238)	(9.2)
06A6AH1□□	266.5	186.5	4.3
	(320.5)	(240.5)	(4.9)
06A6AHB□□			4.5
			(5.1)
06A6AHC□□	352.5	219.5	9.1
06A6AH7□□	(406.5)	(273.5)	(9.7)
08A6AH1□□	263	183	5.2
	(310)	(230)	(5.8)
08A6AHB□□			5.4
			(6.0)
08A6AHC□□	342	209	10.1
08A6AH7□□	(389)	(256)	(10.7)

• Shaft End Specification: Flange Output

Model SGM7J-	L	Approx. Mass [kg]
A5A6AH10□	119	0.6 (0.9)
A5A6AH20□	(159.5)	
A5A6AHC0□	128	1.2 (1.5)
A5A6AH70□	(168.5)	
A5A6AH70□	149.5	0.7 (1.0)
01A6AH10□	(190)	
01A6AH10□	131	1.3 (1.6)
01A6AHB0□	(171.5)	
01A6AHC0□	161.5	2.4 (2.7)
01A6AH70□	(202)	
01A6AH70□	170	0.8 (1.1)
C2A6AH10□	(210.5)	
C2A6AH10□	143	1.4 (1.7)
C2A6AHB0□	(191)	
C2A6AHC0□	173.5	2.5 (2.8)
C2A6AH70□	(221.5)	
C2A6AH70□	182	1.7 (2.3)
02A6AH10□	(230)	
02A6AH10□	162.5	1.8 (2.4)
02A6AHB0□	(203)	
02A6AHC0□	175.5	3.3 (3.9)
02A6AH70□	(216)	
04A6AH10□	178.5	2.0 (2.6)
04A6AHB0□	(219)	
04A6AHB0□	191.5	3.6 (4.2)
04A6AHC0□	(232)	
04A6AH70□	232.5	7.2 (7.8)
04A6AH70□	(273)	
06A6AH10□	213.5	3.9 (4.5)
06A6AHB0□	(267.5)	
06A6AHB0□	254.5	7.7 (8.3)
06A6AHC0□	(308.5)	
06A6AH70□	210	4.8 (5.4)
08A6AH10□	(257)	
08A6AHB0□		5.0 (5.6)
08A6AHC0□	244	8.7 (9.3)
08A6AH70□	(291)	

Note: The values in parentheses are for Servomotors with Holding Brakes.

Specifications, Ratings, and External Dimensions of SGM7A Servomotors

5

This chapter describes how to interpret the model numbers of SGM7A Servomotors and gives their specifications, ratings, and external dimensions.

5.1 Model Designations 5-2

- 5.1.1 Without Gears 5-2
- 5.1.2 With Gears 5-2

5.2 Specifications and Ratings 5-3

- 5.2.1 Specifications 5-3
- 5.2.2 Ratings of Servomotors without Gears for the SGM7A-A5 to -10 5-4
- 5.2.3 Torque-Motor Speed Characteristics of the SGM7A-A5 to -10 5-6
- 5.2.4 Ratings of Servomotors without Gears for the SGM7A-15 to -70 5-7
- 5.2.5 Torque-Motor Speed Characteristics of the SGM7A-15 to -70 5-9
- 5.2.6 Ratings of Servomotors with Gears 5-10
- 5.2.7 Servomotor Overload Protection Characteristics 5-12
- 5.2.8 Allowable Load Moment of Inertia 5-13
- 5.2.9 Derating Rates 5-14

5.3 External Dimensions 5-16

- 5.3.1 Servomotors without Gears 5-16
- 5.3.2 Servomotors without Gears and without Holding Brakes 5-19
- 5.3.3 Servomotors without Gears and with Holding Brakes 5-22
- 5.3.4 Servomotors with Gears 5-25

5.1 Model Designations

5.1.1 Without Gears

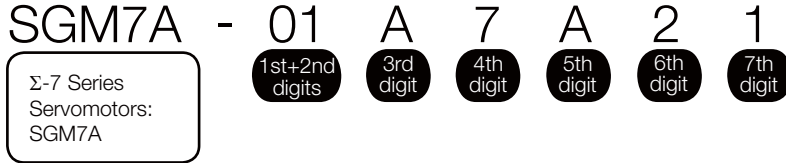

1st+2nd digits Rated Output

Code	Specification
A5	50 W
01	100 W
C2	150 W
02	200 W
04	400 W
06	600 W
08	750 W
10	1.0 kW
15	1.5 kW
20	2.0 kW
25	2.5 kW
30	3.0 kW
40	4.0 kW
50	5.0 kW
70	7.0 kW

3rd digit Power Supply Voltage

Code	Specification
A	200 VAC

4th digit Serial Encoder

Code	Specification
6	24-bit batteryless absolute
7	24-bit absolute
F	24-bit incremental

5th digit Design Revision Order

A

6th digit Shaft End

Code	Specification
2	Straight without key
6	Straight with key and tap
B*	With two flat seats

* Code B is not supported for models with a rated output of 1.5 kW or higher.

7th digit Options

Code	Specification
1	Without options
C	With holding brake (24 VDC)
E	With oil seal and holding brake (24 VDC)
S	With oil seal

Note: SGM7A-70A Servomotors with holding brakes are not available.

5.1.2 With Gears

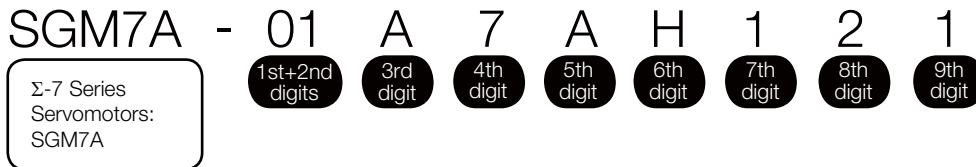

1st+2nd digits Rated Output

Code	Specification
A5	50 W
01	100 W
C2	150 W
02	200 W
04	400 W
06	600 W
08	750 W
10	1.0 kW

3rd digit Power Supply Voltage

Code	Specification
A	200 VAC

4th digit Serial Encoder

Code	Specification
6	24-bit batteryless absolute
7	24-bit absolute
F	24-bit incremental

5th digit Design Revision Order

A

6th digit Gear Type

Code	Specification
H	HDS planetary low-backlash gear

7th digit Gear Ratio

Code	Specification
B	1/11 ^{*1}
C	1/21
1	1/5
2	1/9 ^{*2}
7	1/33

*1. This specification is not supported for models with a rated output of 50 W.

*2. This specification is supported only for models with a rated output of 50 W.

8th digit Shaft End

Code	Specification
0	Flange output
2	Straight without key
6	Straight with key and tap

9th digit Options

Code	Specification
1	Without options
C	With holding brake (24 VDC)

Note: Contact your Yaskawa representative for models of 1.5 kW or higher.

5.2

Specifications and Ratings

5.2.1 Specifications

Voltage		200 V									
Model SGM7A-	A5A	01A	C2A, 02A	04A	06A, 08A	10A	15A	20A	25A, 30A	40A, 50A	70A
Time Rating	Continuous										
Thermal Class	UL: B, CE: B						UL: F, CE: F				
Insulation Resistance	500 VDC, 10 MΩ min.										
Withstand Voltage	1,500 VAC for 1 minute										
Excitation	Permanent magnet										
Mounting	Flange-mounted										
Drive Method	Direct drive										
Rotation Direction	Counterclockwise (CCW) for forward reference when viewed from the load side										
Vibration Class*1	V15										
Environmental Conditions	Surrounding Air Temperature	0°C to 40°C (With derating, usage is possible between 40°C and 60°C.)*3									
	Surrounding Air Humidity	20% to 80% relative humidity (with no condensation)									
	Installation Site	<ul style="list-style-type: none"> • Must be indoors and free of corrosive and explosive gases. • Must be well-ventilated and free of dust and moisture. • Must facilitate inspection and cleaning. • Must have an altitude of 1,000 m or less. (With derating, usage is possible between 1,000 m and 2,000 m.)*3 • Must be free of strong magnetic fields. 									
	Storage Environment	Store the Servomotor in the following environment if you store it with the power cable disconnected. Storage temperature: -20°C to 60°C (with no freezing) Storage humidity: 20% to 80% relative humidity (with no condensation)									
Shock Resistance*2	Impact Acceleration Rate at Flange	490 m/s ²									
	Number of Impacts	2 times									
Vibration Resistance*2	Vibration Acceleration Rate at Flange	49 m/s ² (Models 15A to 50A: 24.5 m/s ² front to back)									14.7 m/s ²
Applicable SERVO-PACKs	SGD7S-	R70A, R70F	R90A, R90F	1R6A, 2R1F	2R8A, 2R8F	5R5A	120A	180A	200A	330A	550A
	SGD7W- SGD7C-	1R6A*4, 2R8A*4		1R6A, 2R8A*4	2R8A, 5R5A*4, 7R6A*4	5R5A,7 R6A	-				

*1. A vibration class of V15 indicates a vibration amplitude of 15 μm maximum on the Servomotor without a load at the rated motor speed.

*2. The given values are for when the Servomotor shaft is mounted horizontally and shock or vibration is applied in the directions shown in the following figures.

The strength of the vibration that the Servomotor can withstand depends on the application. Always check the vibration acceleration rate that is applied to the Servomotor with the actual equipment.

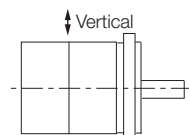

Shock Applied to the Servomotor

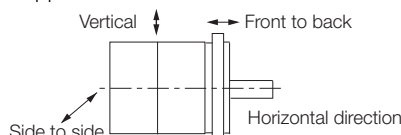

Vibration Applied to the Servomotor

*3. Refer to the following section for the derating rates.

 5.2.9 Derating Rates on page 5-14

5.2 Specifications and Ratings

5.2.2 Ratings of Servomotors without Gears for the SGM7A-A5 to -10

*4. If you use the Servomotor together with a Σ -7W or Σ -7C SERVOPACK, the control gain may not increase as much as with a Σ -7S SERVOPACK and other performances may be lower than those achieved with a Σ -7S SERVOPACK.

5.2.2 Ratings of Servomotors without Gears for the SGM7A-A5 to -10

Voltage		200 V									
Model SGM7A-		A5A	01A	C2A	02A	04A	06A	08A	10A		
Rated Output* ¹	W	50	100	150	200	400	600	750	1000		
Rated Torque* ^{1, *2}	N·m	0.159	0.318	0.477	0.637	1.27	1.91	2.39	3.18		
Instantaneous Maximum Torque* ¹	N·m	0.557	1.11	1.67	2.23	4.46	6.69	8.36	11.1		
Rated Current* ¹	Arms	0.57	0.89	1.5	1.5	2.4	4.5	4.4	6.4		
Instantaneous Maximum Current* ¹	Arms	2.1	3.2	5.6	5.9	9.3	16.9	16.8	23.2		
Rated Motor Speed* ¹	min ⁻¹	3000									
Maximum Motor Speed* ¹	min ⁻¹	6000									
Torque Constant	N·m/Arms	0.304	0.384	0.332	0.458	0.576	0.456	0.584	0.541		
Motor Moment of Inertia	kg·m ²	0.0217	0.0337	0.0458	0.139	0.216	0.315	0.775	0.971		
		With Holding Brake	×10 ⁻⁴	0.0297	0.0417	0.0538	0.209	0.286	0.385	0.955	1.15
		With Batteryless Absolute Encoder	0.0232	0.0352	0.0473	0.140	0.217	0.316	0.776	0.972	
Rated Power Rate* ¹	kW/s	11.7	30.0	49.7	29.2	74.7	115	73.7	104		
		With Holding Brake	8.51	24.2	42.2	19.4	56.3	94.7	59.8	87.9	
Rated Angular Acceleration Rate* ¹	rad/s ²	73200	94300	104000	45800	58700	60600	30800	32700		
		With Holding Brake	53500	76200	88600	30400	44400	49600	25000	27600	
Derating Rate for Servomotor with Oil Seal	%	80	90			95					
Heat Sink Size (Aluminum)* ³	mm	200 × 200 × 6		250 × 250 × 6			300 × 300 × 12 ^{*)}	250 × 250 × 6	300 × 300 × 12		
Protective Structure* ⁴	Totally enclosed, self-cooled, IP67										
Holding Brake Specifications* ⁵	Rated Voltage	V	24 VDC ±10%								
	Capacity	W	5.5			6		6.5			
	Holding Torque	N·m	0.159	0.318	0.477	0.637	1.27	1.91	2.39	3.18	
	Coil Resistance	Ω (at 20°C)	104.8 ±10%			96 ±10%		88.6 ±10%			
	Rated Current	A (at 20°C)	0.23			0.25		0.27			
	Time Required to Release Brake	ms	60					80			
	Time Required to Brake	ms	100								

Continued on next page.

Continued from previous page.

Voltage			200 V							
Model SGM7A-			A5A	01A	C2A	02A	04A	06A	08A	10A
Allowable Load Moment of Inertia (Motor Moment of Inertia Ratio)*6			40 times			30 times	20 times		20 times	
			With External Regenerative Resistor and External Dynamic Brake Resistor*7			40 times			30 times	20 times
Allowable Shaft Loads*8	LF	mm	20			25		35		
	Allowable Radial Load	N	78			245		392		
	Allowable Thrust Load	N	54			74		147		

- *1. These values are for operation in combination with a SERVOPACK when the temperature of the armature winding is 100°C. The values for other items are at 20°C. These are typical values.
- *2. The rated torques are the continuous allowable torque values at a surrounding air temperature of 40°C with an aluminum heat sink of the dimensions given in the table.
- *3. Refer to the following section for the relation between the heat sinks and derating rate.
 *Servomotor Heat Dissipation Conditions on page 5-14*
- *4. This does not apply to the shaft opening. Protective structure specifications apply only when the special cable is used.
- *5. Observe the following precautions if you use a Servomotor with a Holding Brake.
 - The holding brake cannot be used to stop the Servomotor.
 - The time required to release the brake and the time required to brake depend on which discharge circuit is used. Confirm that the operation delay time is appropriate for the actual equipment.
 - The 24-VDC power supply is not provided by Yaskawa.
- *6. The motor moment of inertia scaling factor is the value for a standard Servomotor without a Holding Brake.
- *7. To externally connect a dynamic brake resistor, select hardware option specification 020 for the SERVOPACK. However, you cannot externally connect a dynamic brake resistor if you use the following SERVOPACKs (maximum applicable motor capacity: 400 W).
 - SGD7S-R70□□□A020 to -2R8□□□A020
 - SGD7W-1R6A20A020 to -2R8A20A020
 - SGD7C-1R6AMAA020 to -2R8AMAA020
- *8. Design the mechanical system so that the thrust and radial loads applied to the Servomotor shaft end during operation do not exceed the values given in the table.

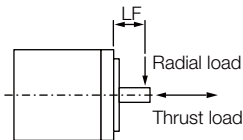

- *9. If the heat sink is 250 mm × 250 mm × 6 mm, the rated output is 550 W and the rated torque is 1.75 N·m. Refer to the following section for details.
 *Servomotor Heat Dissipation Conditions on page 5-14*

5.2 Specifications and Ratings

5.2.3 Torque-Motor Speed Characteristics of the SGM7A-A5 to -10

5.2.3 Torque-Motor Speed Characteristics of the SGM7A-A5 to -10

A : Continuous duty zone — (solid lines): With three-phase 200-V or single-phase 230-V input
B : Intermittent duty zone - - - (dotted lines): With single-phase 200-V input
 (dashed-dotted lines): With single-phase 100-V input

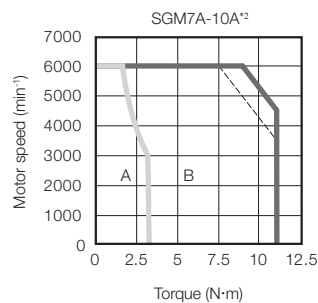
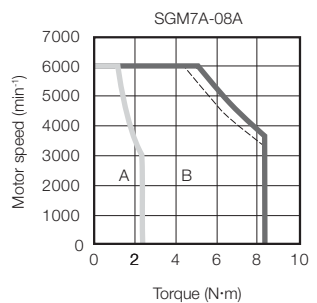
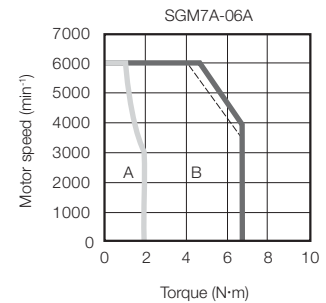
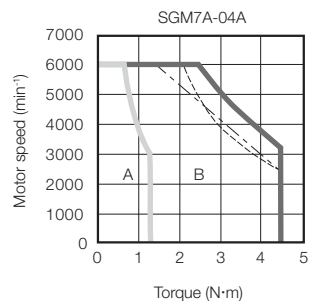
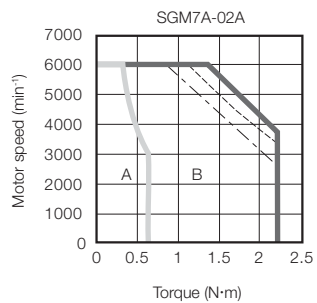
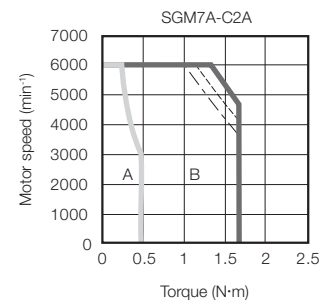
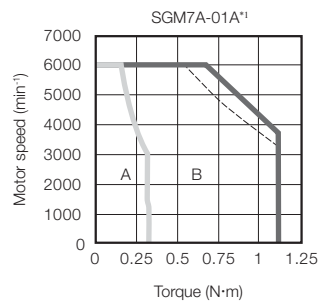
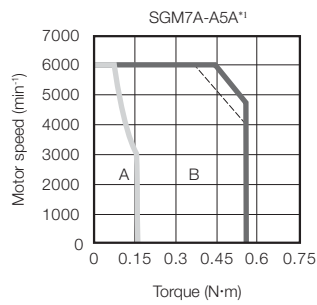

*1. The characteristics are the same for a single-phase 200-V and single-phase 100-V input.

*2. A single-phase power input can be used in combination with the SGD7S-120A□□A008.

Note: 1. These values (typical values) are for operation in combination with a SERVOPACK when the temperature of the armature winding is 100°C.

2. The characteristics in the intermittent duty zone depend on the power supply voltage.
3. If the effective torque is within the allowable range for the rated torque, the Servomotor can be used within the intermittent duty zone.
4. If you use a Servomotor Main Circuit Cable that exceeds 20 m, the intermittent duty zone in the torque-motor speed characteristics will become smaller because the voltage drop increases.

5.2.4 Ratings of Servomotors without Gears for the SGM7A-15 to -70

Voltage		200 V							
Model SGM7A-		15A	20A	25A	30A	40A	50A	70A	
Rated Output ^{*1}	kW	1.5	2.0	2.5	3.0	4.0	5.0	7.0	
Rated Torque ^{*1, *2}	N·m	4.90	6.36	7.96	9.80	12.6	15.8	22.3	
Instantaneous Maximum Torque ^{*1}	N·m	14.7	19.1	23.9	29.4	37.8	47.6	54.0	
Rated Current ^{*1}	Arms	9.3	12.1	15.6	17.9	25.4	27.6	38.3	
Instantaneous Maximum Current ^{*1}	Arms	28	42	51	56	77	84	105	
Rated Motor Speed ^{*1}	min ⁻¹	3000							
Maximum Motor Speed ^{*1}	min ⁻¹	6000 ^{*9}							
Torque Constant	N·m/Arms	0.590	0.561	0.538	0.582	0.519	0.604	0.604	
Motor Moment of Inertia	×10 ⁻⁴ kg·m ²	2.00	2.47	3.19	7.00	9.60	12.3	12.3	
With Holding Brake		2.25	2.72	3.44	9.20	11.8	14.5	–	
With Batteryless Absolute Encoder		2.00	2.47	3.19	7.00	9.60	12.3	12.3	
Rated Power Rate	kW/s	120	164	199	137	165	203	404	
With Holding Brake		106	148	184	104	134	172	–	
Rated Angular Acceleration Rate	rad/s ²	24500	25700	24900	14000	13100	12800	18100	
With Holding Brake		21700	23300	23100	10600	10600	10800	–	
Heat Sink Size (aluminum) ^{*3}	mm	300 × 300 × 12			400 × 400 × 20				
Protective Structure ^{*4}	Totally enclosed, self-cooled, IP67							Totally enclosed, separately cooled (with fan), IP22	
Holding Brake Specifications ^{*5}	Rated Voltage	V	24 VDC ^{+10%} ₀						–
	Capacity	W	12			10			
	Holding Torque	N·m	7.84		10		20		
	Coil Resistance	Ω (at 20°C)	48			59			
	Rated Current	A (at 20°C)	0.5			0.41			
	Time Required to Release Brake	ms	170			100			
	Time Required to Brake	ms	80						
Allowable Load Moment of Inertia (Motor Moment of Inertia Ratio) ^{*6}			10 times			5 times			
	With External Regenerative Resistor and External Dynamic Brake Resistor ^{*7}		20 times			15 times			
Allowable Shaft Loads ^{*8}	LF	mm	45			63			
	Allowable Radial Load	N	686		980		1176		
	Allowable Thrust Load	N	196			392			

*1. These values are for operation in combination with a SERVOPACK when the temperature of the armature winding is 20°C. These are typical values.

5.2 Specifications and Ratings

5.2.4 Ratings of Servomotors without Gears for the SGM7A-15 to -70

- *2. The rated torques are the continuous allowable torque values at a surrounding air temperature of 40°C with an aluminum heat sink of the dimensions given in the table.
- *3. Refer to the following section for the relation between the heat sinks and derating rate.
 *Servomotor Heat Dissipation Conditions* on page 5-14
- *4. This does not apply to the shaft opening. Protective structure specifications apply only when the special cable is used.
- *5. Observe the following precautions if you use a Servomotor with a Holding Brake.
 - The holding brake cannot be used to stop the Servomotor.
 - The time required to release the brake and the time required to brake depend on which discharge circuit is used. Confirm that the operation delay time is appropriate for the actual equipment.
 - The 24-VDC power supply is not provided by Yaskawa.
- *6. The motor moment of inertia scaling factor is the value for a standard Servomotor without a Holding Brake.
- *7. To externally connect a dynamic brake resistor, select hardware option specification 020 for the SERVOPACK. However, you cannot externally connect a dynamic brake resistor if you use the following SERVOPACKs (maximum applicable motor capacity: 400 W).
 - SGD7S-R70□□□A020 to -2R8□□□A020
 - SGD7W-1R6A20A020 to -2R8A20A020
 - SGD7C-1R6AMAA020 to -2R8AMAA020
- *8. Design the mechanical system so that the thrust and radial loads applied to the Servomotor shaft end during operation do not exceed the values given in the table.

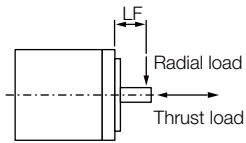

- *9. For the SGM7A-25A or SGM7A-50A, the maximum motor speed for the continuous duty zone is 5,000 min⁻¹. Use the Servomotor within the continuous duty zone for the average motor speed and effective torque.

5.2.5 Torque-Motor Speed Characteristics of the SGM7A-15 to -70

A : Continuous duty zone — (solid lines): With three-phase 200-V or single-phase 230-V input
B : Intermittent duty zone - - - (dotted lines): With single-phase 200-V input

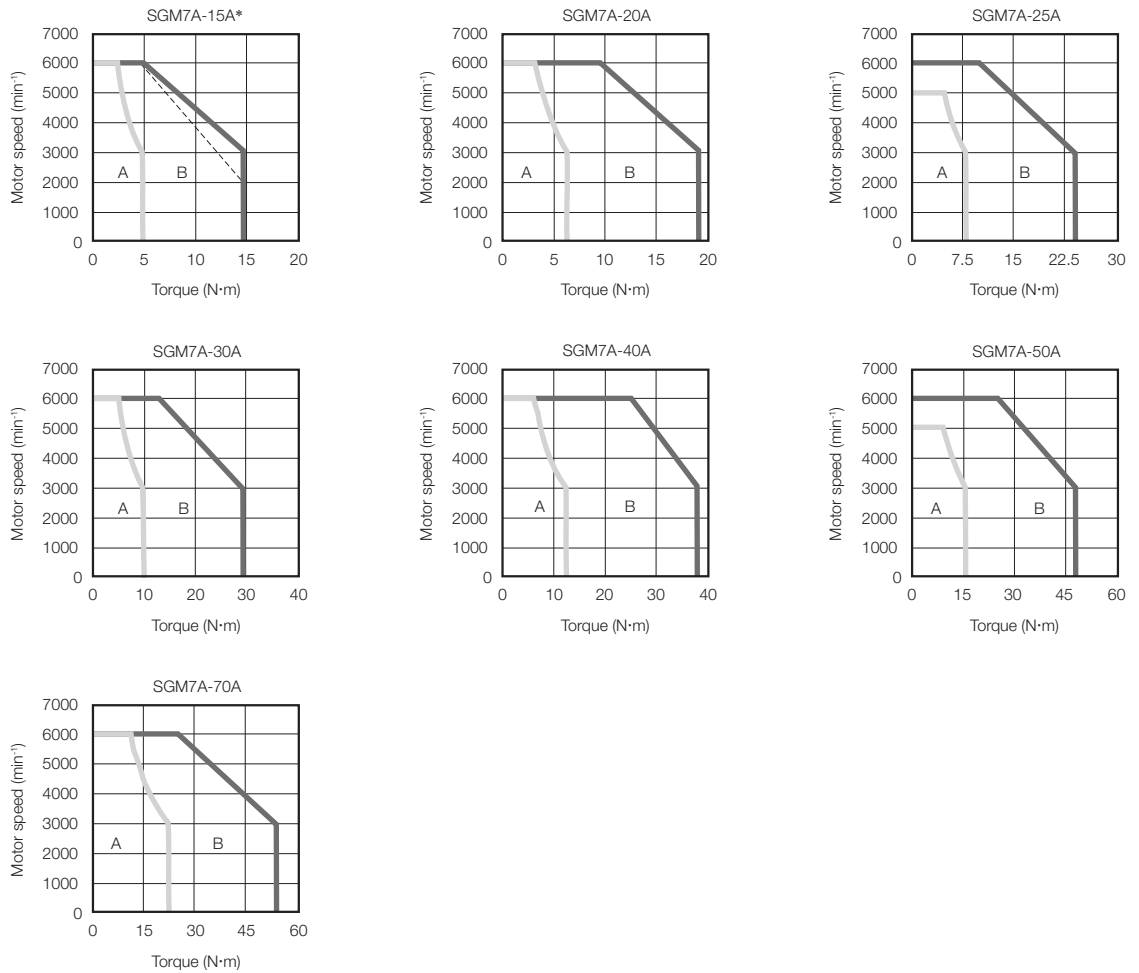

* A single-phase power input can be used in combination with the SGD7S-120A□□A008.

- Note: 1. These values (typical values) are for operation in combination with a SERVOPACK when the temperature of the armature winding is 20°C.
2. The characteristics in the intermittent duty zone depend on the power supply voltage.
3. If the effective torque is within the allowable range for the rated torque, the Servomotor can be used within the intermittent duty zone.
4. If you use a Servomotor Main Circuit Cable that exceeds 20 m, the intermittent duty zone in the torque-motor speed characteristics will become smaller because the voltage drop increases.

5.2.6 Ratings of Servomotors with Gears

All Models	Gear Mechanism		Protective Structure			Lost Motion [arc-min]				
	Planetary gear mechanism		Totally enclosed, self-cooled, IP55 (except for shaft opening)			3 max.				
Servomotor Model SGM7A-	Servomotor					Gear Output				
	Rated Output [W]	Rated Motor Speed [min ⁻¹]	Maximum Motor Speed [min ⁻¹]	Rated Torque [N·m]	Instantaneous Maximum Torque [N·m]	Gear Ratio	Rated Torque/Efficiency* ¹ [N·m/%]	Instantaneous Maximum Torque [N·m]	Rated Motor Speed [min ⁻¹]	Maximum Motor Speed [min ⁻¹]
A5A□AH1□	50	3000	6000	0.159	0.557	1/5	0.433/64* ²	2.37	600	1200
A5A□AH2□						1/9	1.12/78	3.78* ³	333	667
A5A□AHC□						1/21	2.84/85	10.6	143	286
A5A□AH7□						1/33	3.68/70	15.8	91	182
01A□AH1□	100	3000	6000	0.318	1.11	1/5	1.06/78* ²	4.96	600	1200
01A□AHB□						1/11	2.52/72	10.7	273	545
01A□AHC□						1/21	5.35/80	20.8	143	286
01A□AH7□						1/33	7.35/70	32.7	91	182
C2A□AH1□	150	3000	6000	0.477	1.67	1/5	1.68/83* ²	7.80	600	1200
C2A□AHB□						1/11	3.53/79* ²	16.9	273	545
C2A□AHC□						1/21	6.30/70* ²	31.0	143	286
C2A□AH7□						1/33	11.2/79* ²	49.7	91	182
02A□AH1□	200	3000	6000	0.637	2.23	1/5	2.39/75	9.80	600	1200
02A□AHB□						1/11	5.74/82	22.1	273	545
02A□AHC□						1/21	10.2/76	42.1	143	286
02A□AH7□						1/33	17.0/81	67.6	91	182
04A□AH1□	400	3000	6000	1.27	4.46	1/5	5.35/84	20.1	600	1200
04A□AHB□						1/11	11.5/82	45.1	273	545
04A□AHC□						1/21	23.0/86	87.0	143	286
04A□AH7□						1/33	34.0/81	135	91	182
06A□AH1□	600	3000	6000	1.91	6.69	1/5	7.54/79	30.5	600	1200
06A□AHB□						1/11	18.1/86	68.6	273	545
06A□AHC□						1/21	32.1/80	129	143	286
06A□AH7□						1/33	53.6/85	206	91	182
08A□AH1□	750	3000	6000	2.39	8.36	1/5	10.0/84	38.4	600	1200
08A□AHB□						1/11	23.1/88	86.4	273	545
08A□AHC□						1/21	42.1/84	163	143	286
08A□AH7□						1/33	69.3/88	259	91	182
10A□AH1□	1000	3000	6000	3.18	11.1	1/5	13.7/86	52.5	600	1200
10A□AHB□						1/11	29.1/83	111	273	545
10A□AHC□						1/21	58.2/87	215	143	286
10A□AH7□						1/33	94.5/90	296* ³	91	182

*1. The gear output torque is expressed by the following formula.

$$\text{Gear output torque} = \text{Servomotor output torque} \times \frac{1}{\text{Gear ratio}} \times \text{Efficiency}$$

The gear efficiency depends on operating conditions such as the output torque, motor speed, and temperature. The values in the table are typical values for the rated torque, rated motor speed, and a surrounding air temperature of 25°C. They are reference values only.

*2. When using an SGM7A-A5A, SGM7A-01A, or SGM7A-C2A Servomotor with a gear ratio of 1/5 or an SGM7A-C2A Servomotor with a gear ratio of 1/11, maintain an 85% maximum effective load ratio. For an SGM7A-C2A Servomotor with a gear ratio of 1/21 or 1/33, maintain a 90% maximum effective load ratio. The values in the table take the effective load ratio into consideration.

*3. The instantaneous maximum torque is 300% of the rated torque.

- Note: 1. The gears that are mounted to Yaskawa Servomotors have not been broken in. Break in the Servomotor if necessary. First, operate the Servomotor at low speed with no load. If no problems occur, gradually increase the speed and load.
2. The no-load torque for a Servomotor with a Gear is high immediately after the Servomotor starts, and it then decreases and becomes stable after a few minutes. This is a common phenomenon caused by grease circulation in the gears and it does not indicate faulty gears.
3. Contact your Yaskawa representative for information on Servomotor with Gears with a rated output of 1.5 kW or higher.
4. Other specifications are the same as those for Servomotors without Gears.

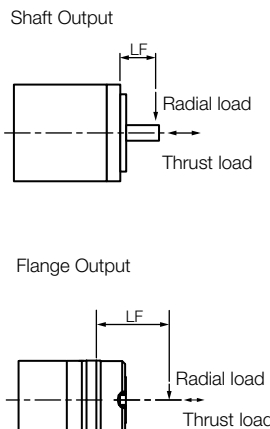

The SERVOPACK speed control range is 1:5,000. If you use Servomotors at extremely low speeds (0.02 min^{-1} or lower at the gear output shaft), if you use Servomotors with a one-pulse feed reference for extended periods, or under some other operating conditions, the gear bearing lubrication may be insufficient. That may cause deterioration of the bearing or increase the load ratio. Contact your Yaskawa representative if you use a Servomotor under these conditions.

Servomotor Model SGM7A-	Moment of Inertia [$\times 10^{-4} \text{ kg} \cdot \text{m}^2$]				With Gears			Reference Diagram
	Shaft Output		Flange Output		Allowable Radial Load [N]	Allowable Thrust Load [N]	LF [mm]	
	Motor* + Gear	Gear	Motor* + Gear	Gear				
A5A□AH1□	0.0277	0.006	0.0267	0.005	95	431	37	
A5A□AH2□	0.0247	0.003	0.0247	0.003	113	514	37	
A5A□AHC□	0.0257	0.004	0.0257	0.004	146	663	37	
A5A□AH7□	0.0667	0.045	0.0667	0.045	267	1246	53	
01A□AH1□	0.0397	0.006	0.0387	0.005	95	431	37	
01A□AHB□	0.0937	0.060	0.0927	0.059	192	895	53	
01A□AHC□	0.0837	0.050	0.0837	0.050	233	1087	53	
01A□AH7□	0.0987	0.065	0.0977	0.064	605	2581	75	
C2A□AH1□	0.0518	0.006	0.0508	0.005	95	431	37	
C2A□AHB□	0.106	0.060	0.105	0.059	192	895	53	
C2A□AHC□	0.156	0.110	0.154	0.108	528	2254	75	
C2A□AH7□	0.111	0.065	0.110	0.064	605	2581	75	
02A□AH1□	0.346	0.207	0.340	0.201	152	707	53	
02A□AHB□	0.332	0.193	0.331	0.192	192	895	53	
02A□AHC□	0.629	0.490	0.627	0.488	528	2254	75	
02A□AH7□	0.589	0.450	0.588	0.449	605	2581	75	
04A□AH1□	0.423	0.207	0.417	0.201	152	707	53	
04A□AHB□	0.786	0.570	0.776	0.560	435	1856	75	
04A□AHC□	0.706	0.490	0.704	0.488	528	2254	75	
04A□AH7□	0.836	0.620	0.826	0.610	951	4992	128	
06A□AH1□	1.02	0.700	0.975	0.660	343	1465	75	
06A□AHB□	0.885	0.570	0.875	0.560	435	1856	75	
06A□AHC□	1.16	0.840	1.14	0.820	830	4359	128	
06A□AH7□	0.935	0.620	0.925	0.610	951	4992	128	
08A□AH1□	1.48	0.700	1.44	0.660	343	1465	75	
08A□AHB□	1.38	0.600	1.37	0.590	435	1856	75	
08A□AHC□	3.78	3.00	3.76	2.98	830	4359	128	
08A□AH7□	3.58	2.80	3.57	2.79	951	4992	128	
10A□AH1□	1.67	0.700	1.63	0.660	343	1465	75	
10A□AHB□	4.37	3.40	4.31	3.34	684	3590	128	
10A□AHC□	3.97	3.00	3.95	2.98	830	4359	128	
10A□AH7□	3.77	2.80	3.76	2.79	951	4992	128	

* The moment of inertia for the Servomotor and gear is the value without a holding brake. You can calculate the moment of inertia for a Servomotor with a Gear and Holding Brake with the following formula.
 Motor moment of inertia for a Servomotor with a Holding Brake from 5.2.2 Ratings of Servomotors without Gears for the SGM7A-A5 to -10 on page 5-4 + Moment of inertia for the gear from the above table.



Important

During operation, the gear generates the loss at the gear mechanism and oil seal. The loss depends on the torque and motor speed conditions. The temperature rise depends on the loss and heat dissipation conditions. For the heat dissipation conditions, always refer to the following table and check the gear and motor temperatures with the actual equipment. If the temperature is too high, implement the following measures.

- Decrease the load ratio.
- Change the heat dissipation conditions.
- Use forced-air cooling for the motor with a cooling fan or other means.

Model	Heat Sink Size			
	1/5	1/9 or 1/11	1/21	1/33
SGM7A-A5	A			
SGM7A-01	B			
SGM7A-C2				
SGM7A-02	C			
SGM7A-04				
SGM7A-06				
SGM7A-08				
SGM7A-10A				

• A: 250 mm × 250 mm × 6 mm, aluminum plate
 • B: 300 mm × 300 mm × 12 mm, aluminum plate
 • C: 350 mm × 350 mm × 12 mm, aluminum plate

5.2.7 Servomotor Overload Protection Characteristics

The overload detection level is set for hot start conditions with a Servomotor surrounding air temperature of 40°C.

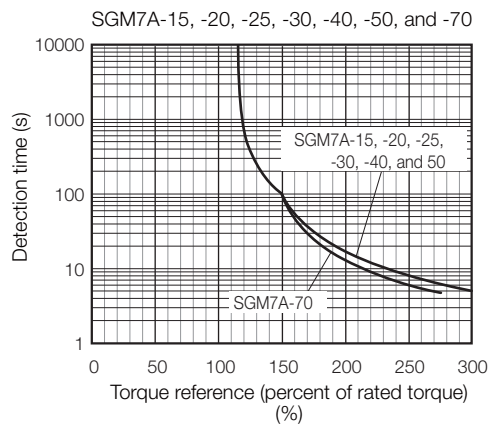
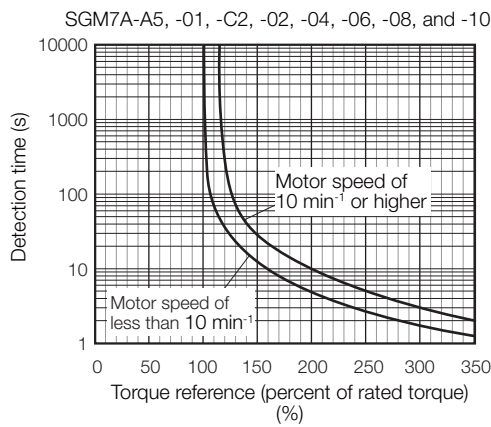

Note: The above overload protection characteristics do not mean that you can perform continuous duty operation with an output of 100% or higher. Use the Servomotor so that the effective torque remains within the continuous duty zone given in 5.2.3 *Torque-Motor Speed Characteristics of the SGM7A-A5 to -10* on page 5-6 or in 5.2.5 *Torque-Motor Speed Characteristics of the SGM7A-15 to -70* on page 5-9.

5.2.8 Allowable Load Moment of Inertia

The allowable load moments of inertia (motor moment of inertia ratios) for the Servomotors are given in the Ratings of Servomotors without Gears (pages 5-4 and 5-7). The values are determined by the regenerative energy processing capacity of the SERVOPACK and are also affected by the drive conditions of the Servomotor. Perform the required Steps for each of the following cases.

Use the SigmaSize+ AC Servo Drive Capacity Selection Program to check the driving conditions. Contact your Yaskawa representative for information on this program.

Exceeding the Allowable Load Moment of Inertia

Use one of the following measures to adjust the load moment of inertia to within the allowable value.

- Reduce the torque limit.
- Reduce the deceleration rate.
- Reduce the maximum motor speed.

If the above steps is not possible, install an external regenerative resistor.

Information

An Overvoltage Alarm (A.400) is likely to occur during deceleration if the load moment of inertia exceeds the allowable load moment of inertia. SERVOPACKs with a built-in regenerative resistor may generate a Regenerative Overload Alarm (A.320). Refer to the following catalog for the regenerative power (W) that can be processed by the SERVOPACKs.

📖 AC Servo Drives Σ -7 Series Product Catalog (Document No.: KAEP S800001 23)

Install an External Regenerative Resistor when the built-in regenerative resistor cannot process all of the regenerative power.

SERVOPACKs without Built-in Regenerative Resistors

The following graph shows the allowable load moment of inertia scaling factor of the motor speed (reference values for deceleration operation at or above the rated torque). Application is possible without an external regenerative resistor within the allowable value. However, an External Regenerative Resistor is required in the shaded areas of the graphs.

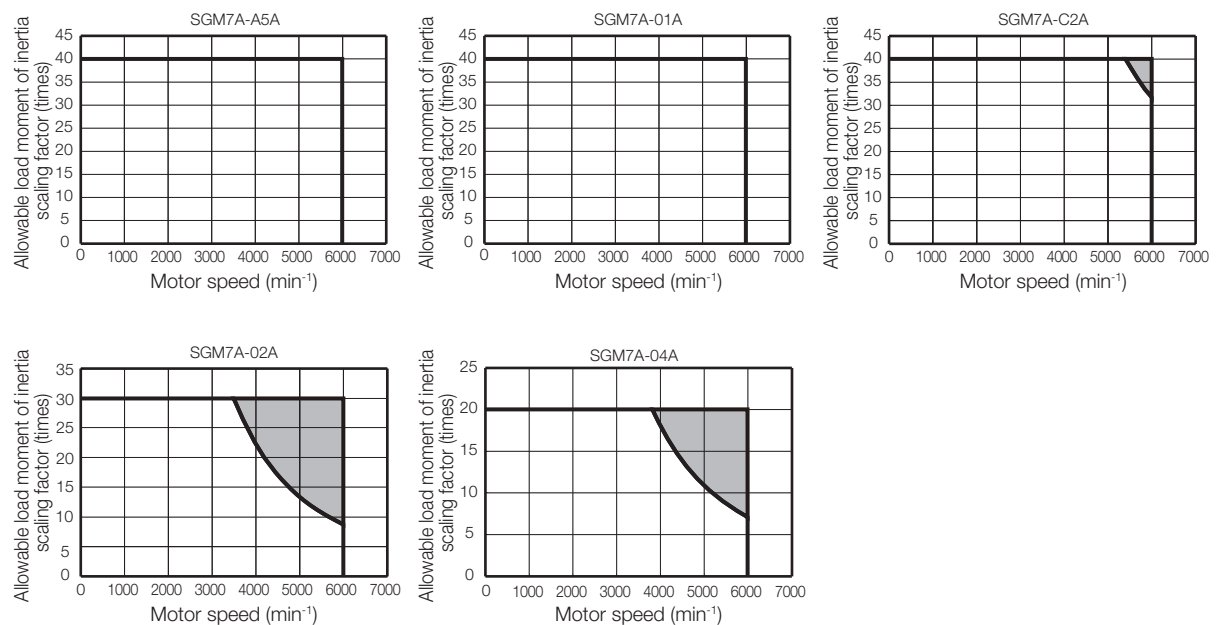

Note: Applicable SERVOPACK models: SGD7S-R70A, -R90A, -1R6A, -2R8A, -R70F, -R90F, -2R1F, and -2R8F

When an External Regenerative Resistor Is Required

Install the External Regenerative Resistor. Refer to the following catalog for the recommended products.

📖 AC Servo Drives Σ -7 Series Product Catalog (Document No.: KAEP S800001 23)

5.2.9 Derating Rates

Servomotor Heat Dissipation Conditions

The Servomotor ratings are the continuous allowable values at a surrounding air temperature of 40°C when a heat sink is installed on the Servomotor. If the Servomotor is mounted on a small device component, the Servomotor temperature may rise considerably because the surface for heat dissipation becomes smaller. Refer to the following graphs for the relation between the heat sink size and derating rate.

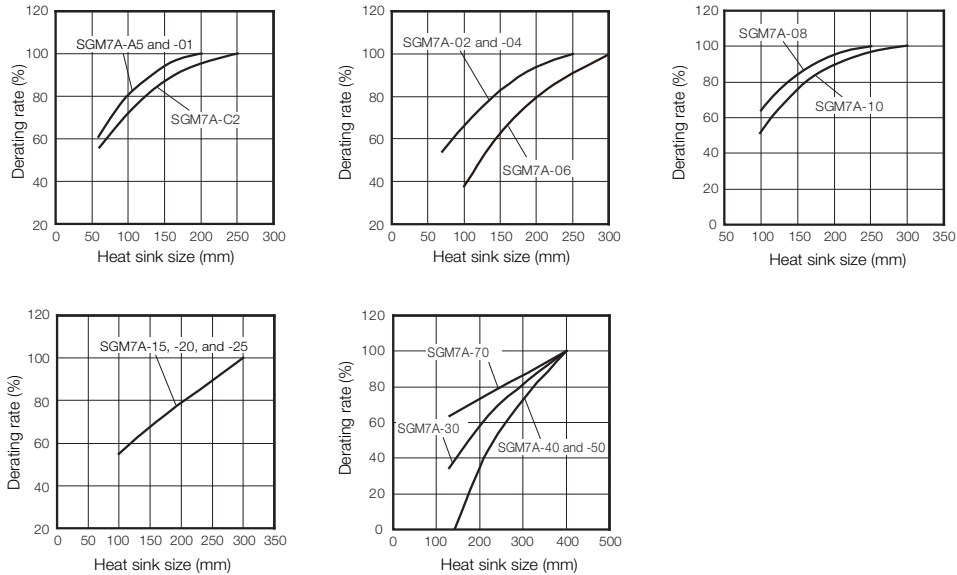

Important

The actual temperature rise depends on the following conditions. Always check the Servomotor temperature with the actual equipment.

- How the heat sink (the Servomotor mounting section) is attached to the installation surface
- Status between heat sink and Servomotor (sealant, reduction gear, etc.)
- What material is used for the Servomotor mounting section
- Servomotor speed

Applications Where the Surrounding Air Temperature Exceeds 40°C

The Servomotor ratings are the continuous allowable values at a surrounding air temperature of 40°C. If you use a Servomotor at a surrounding air temperature that exceeds 40°C (60°C max.), apply a suitable derating rate from the following graphs.

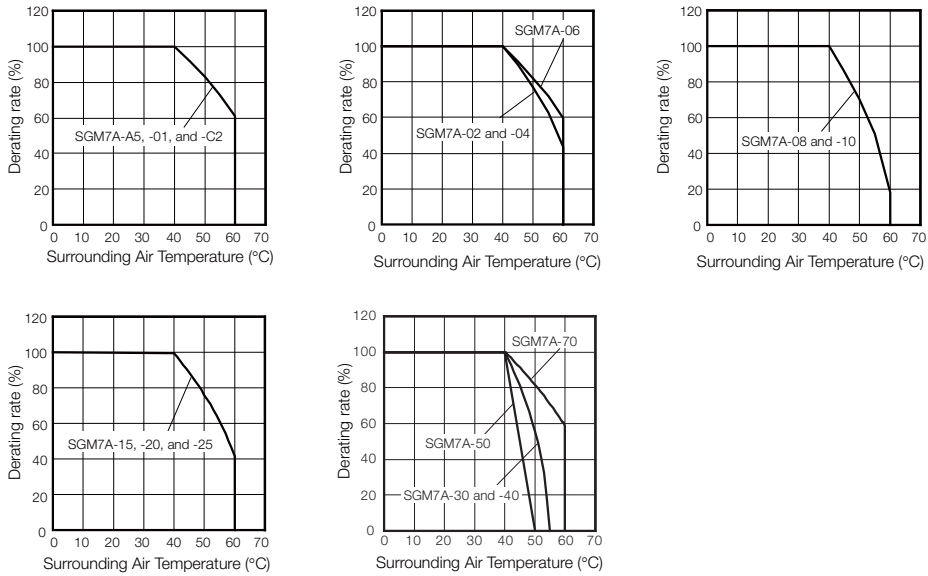

Applications Where the Altitude Exceeds 1,000 m

The Servomotor ratings are the continuous allowable values at an altitude of 1,000 m or less. If you use a Servomotor at an altitude that exceeds 1,000 m (2,000 m max.), the heat dissipation effect of the air is reduced. Apply the appropriate derating rate from the following graphs.

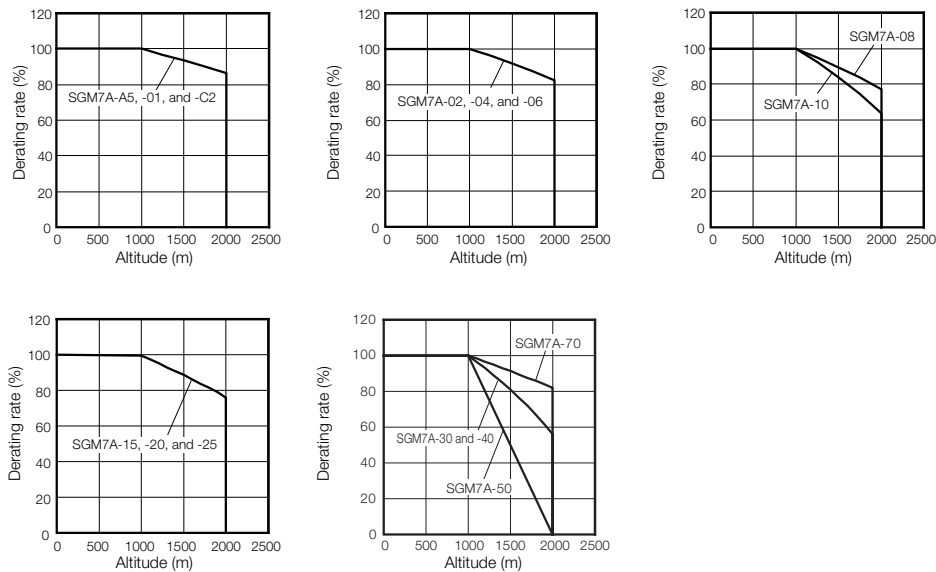

Information

When using Servomotors with derating, change the detection timing of overload warning and overload alarm based on the overload detection level of the motor given in 5.2.7 *Servomotor Overload Protection Characteristics* on page 5-12.

- Note: 1. Use the combination of the SERVOPACK and Servomotor so that the derating conditions are satisfied for both the SERVOPACK and Servomotor.
2. The derating rates are applicable only when the average motor speed is less than or equal to the rated motor speed. If the average motor speed exceeds the rated motor speed, consult with your Yaskawa representative.

5.3 External Dimensions

5.3.1 Servomotors without Gears

SGM7A-A5, -01, and -C2

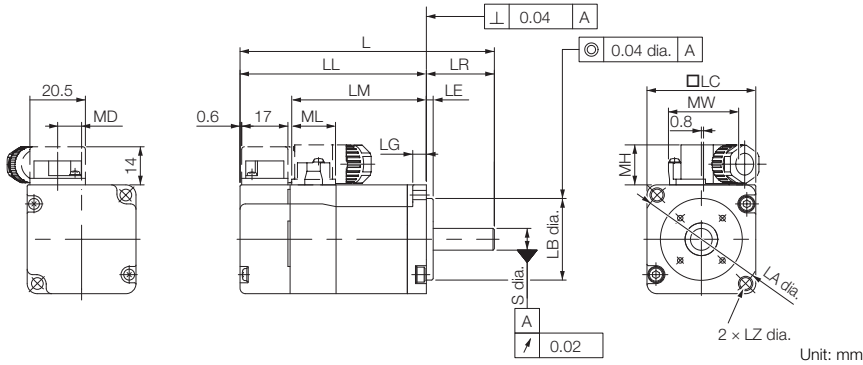

Model SGM7A-	L*	LL*	LM	Flange Dimensions							S	MD	MW	MH	ML	Approx. Mass [kg]
				LR	LE	LG	LC	LA	LB	LZ						
A5A□A2□	81.5 (122)	56.5 (97)	37.9	25	2.5	5	40	46	30 ⁰ _{-0.021}	4.3	8 ⁰ _{-0.009}	8.8	25.8	14.7	16.1	0.3 (0.6)
01A□A2□	93.5 (134)	68.5 (109)	49.9	25	2.5	5	40	46	30 ⁰ _{-0.021}	4.3	8 ⁰ _{-0.009}	8.8	25.8	14.7	16.1	0.4 (0.7)
C2A□A2□	105.5 (153.5)	80.5 (128.5)	61.9	25	2.5	5	40	46	30 ⁰ _{-0.021}	4.3	8 ⁰ _{-0.009}	8.8	25.8	14.7	16.1	0.5 (0.8)

* For models that have a batteryless absolute encoder, L and LL are 8 mm greater than the given value. Refer to the following section for the values for individual models.

Dimensions of Servomotors with Batteryless Absolute Encoders on page 5-31

Note: 1. The values in parentheses are for Servomotors with Holding Brakes.

2. The values for a straight, without key specification are given. Refer to the information given below for other shaft end specifications and option specifications.

◆ Shaft End Specifications

- Straight with Key and Tap

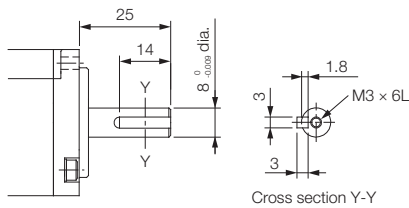

- With Two Flat Seats

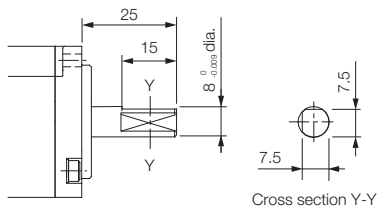

◆ Specifications of Options

- Oil Seal

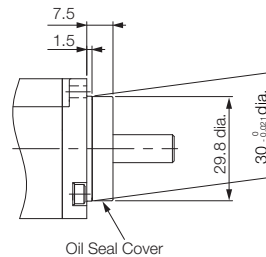

◆ Connector Mounting Dimensions

- Cable Installed on Load Side

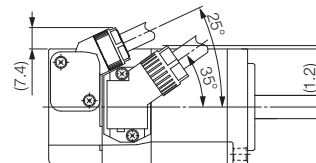

- Cable Installed on Non-load Side

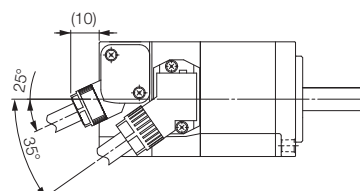

SGM7A-02, -04, and -06

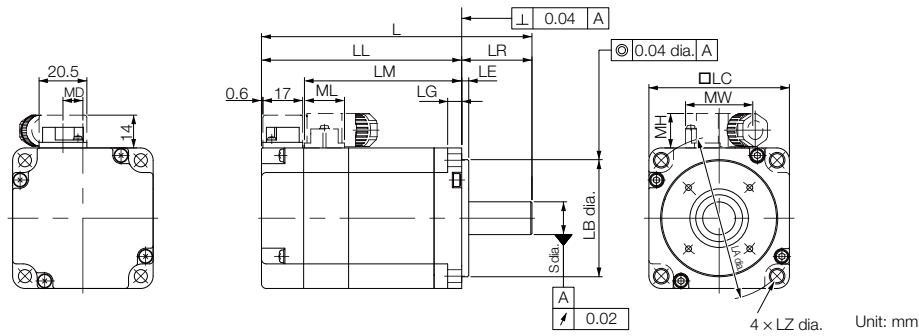

Model SGM7A-	L*	LL*	LM	Flange Dimensions							S	MD	MW	MH	ML	Approx. Mass [kg]
				LR	LE	LG	LC	LA	LB	LZ						
02A□A2□	99.5 (140)	69.5 (110)	51.2	30	3	6	60	70	50 ⁰ _{-0.025}	5.5	14 ⁰ _{-0.011}	8.5	28.7	14.7	17.1	0.8 (1.4)
04A□A2□	115.5 (156)	85.5 (126)	67.2	30	3	6	60	70	50 ⁰ _{-0.025}	5.5	14 ⁰ _{-0.011}	8.5	28.7	14.7	17.1	1.2 (1.8)
06A□A2□	137.5 (191.5)	107.5 (161.5)	89.2	30	3	6	60	70	50 ⁰ _{-0.025}	5.5	14 ⁰ _{-0.011}	8.5	28.7	14.7	17.1	1.6 (2.2)

* For models that have a batteryless absolute encoder, L and LL are 8 mm greater than the given value. Refer to the following section for the values for individual models.

Dimensions of Servomotors with Batteryless Absolute Encoders on page 5-31

Note: 1. The values in parentheses are for Servomotors with Holding Brakes.

2. The values for a straight, without key specification are given. Refer to the information given below for other shaft end specifications and option specifications.

◆ Shaft End Specifications

- Straight with Key and Tap

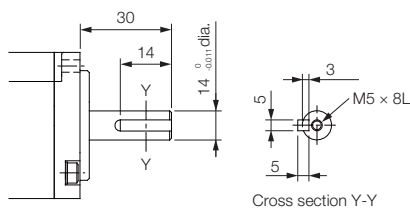

- With Two Flat Seats

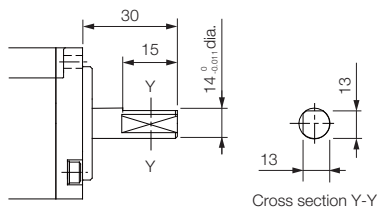

◆ Specifications of Options

- Oil Seal

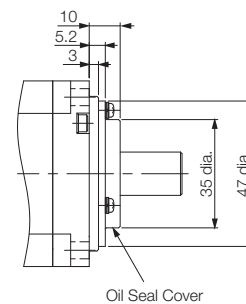

◆ Connector Mounting Dimensions

- Cable Installed on Load Side

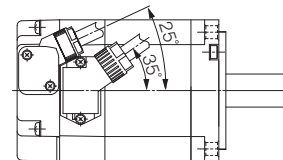

- Cable Installed on Non-load Side

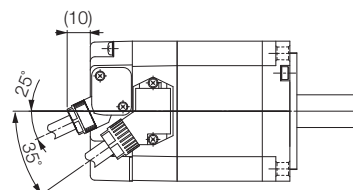

SGM7A-08 and -10

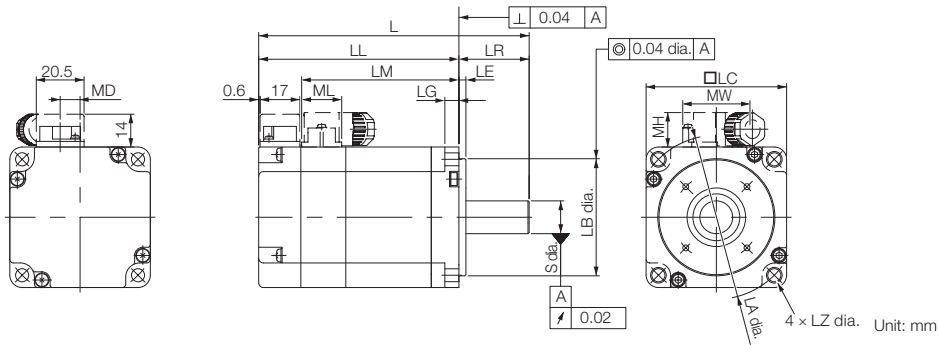

Model SGM7A-	L*	LL*	LM	Flange Dimensions							S	MD	MW	MH	ML	Approx. Mass* [kg]
				LR	LE	LG	LC	LA	LB	LZ						
08A□A2□	137 (184)	97 (144)	78.5	40	3	8	80	90	70 ⁰ _{-0.030}	7	19 ⁰ _{-0.013}	13.6	38	14.7	19.3	2.3 (2.9)
10A□A2□	162 (209)	122 (169)	103.5	40	3	8	80	90	70 ⁰ _{-0.030}	7	19 ⁰ _{-0.013}	13.6	38	14.7	19.3	3.1 (3.7)

* For models that have a batteryless absolute encoder, L and LL are 8 mm greater and the approximate mass is 0.1 kg greater than the given value. Refer to the following section for the values for individual models.

Dimensions of Servomotors with Batteryless Absolute Encoders on page 5-31

Note: 1. The values in parentheses are for Servomotors with Holding Brakes.

2. The values for a straight, without key specification are given. Refer to the information given below for other shaft end specifications and option specifications.

◆ Shaft End Specifications

- Straight with Key and Tap

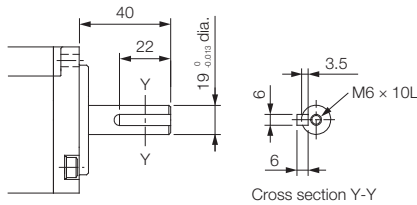

- With Two Flat Seats

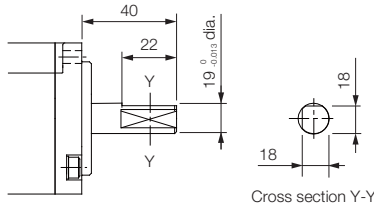

◆ Specifications of Options

- Oil Seal

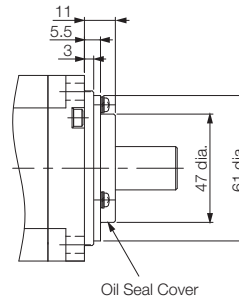

◆ Connector Mounting Dimensions

- Cable Installed on Load Side

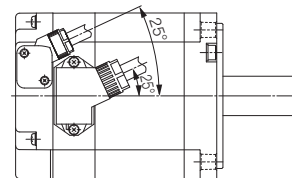

- Cable Installed on Non-load Side

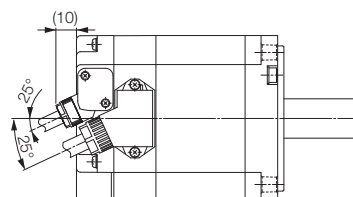

5.3.2 Servomotors without Gears and without Holding Brakes

SGM7A-15, -20, and -25

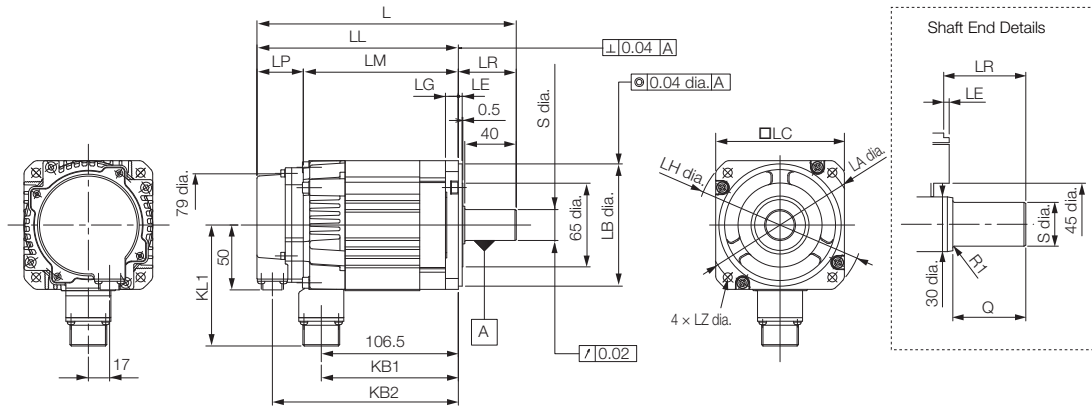

Unit: mm

Model SGM7A-	L*	LL*	LM	LP*	LR	KB1	KB2*	KL1
15A□A21	202	157	121	36	45	107	145	95
20A□A21	218	173	137	36	45	123	161	95
25A□A21	241	196	160	36	45	146	184	95

Model SGM7A-	Flange Dimensions							Shaft End Dimensions		Approx. Mass [kg]
	LA	LB	LC	LE	LG	LH	LZ	S	Q	
15A□A21	115	95 ⁰ _{-0.035}	100	3	10	130	7	24 ⁰ _{-0.013}	40	4.6
20A□A21	115	95 ⁰ _{-0.035}	100	3	10	130	7	24 ⁰ _{-0.013}	40	5.4
25A□A21	115	95 ⁰ _{-0.035}	100	3	10	130	7	24 ⁰ _{-0.013}	40	6.8

* For models that have a batteryless absolute encoder, L, LL, LP, and KB2 are 8 mm greater than the given value. Refer to the following section for the values for individual models.

Dimensions of Servomotors with Batteryless Absolute Encoders on page 5-31

Note: 1. The dimensions are same for models with oil seals.

2. The values for a straight, without key specification are given. Refer to the information given below for other shaft end specifications and option specifications.

◆ Shaft End Specifications

- Straight with Key and Tap

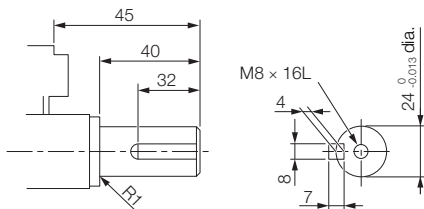

◆ Connector Specifications

- Encoder Connector (24-bit Encoder)

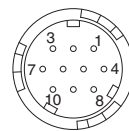

1	PS	6*	BAT(+)
2	/PS	7	-
3	-	8	-
4	PG5V	9	PG0V
5*	BAT(-)	10	FG (frame ground)

* A battery is required only for an absolute encoder.

Receptacle: CM10-R10P-D

Applicable plug: Not provided by Yaskawa.

Plug: CM10-AP10S-□-D for Right-angle Plug

CM10-SP10S-□-D for Straight Plug

(□ depends on the applicable cable size.)

Manufacturer: DDK Ltd.

- Servomotor Connector

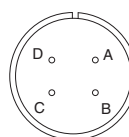

A	Phase U	C	Phase W
B	Phase V	D	FG (frame ground)

Manufacturer: DDK Ltd.

SGM7A-30, -40, and -50

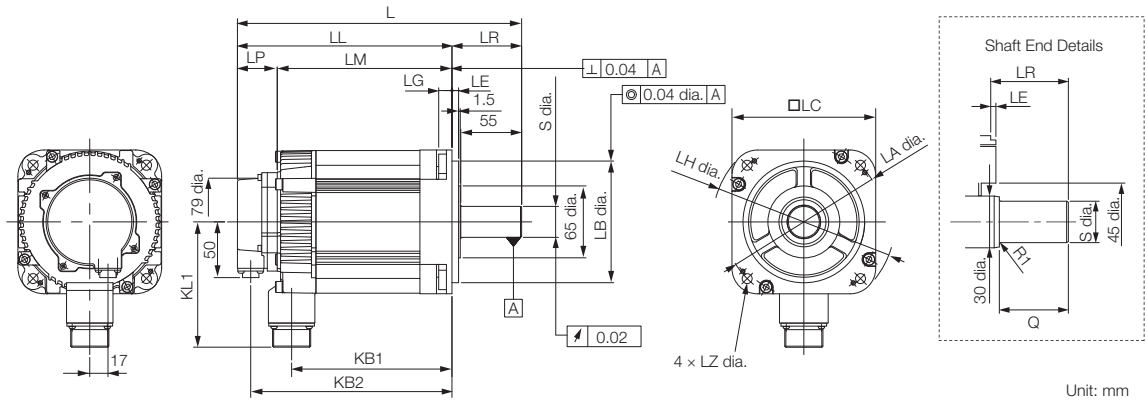

Model SGM7A-	L*	LL*	LM	LP*	LR	KB1	KB2*	KL1
30A□A21	257	194	158	36	63	145	182	114
40A□A21	296	233	197	36	63	184	221	114
50A□A21	336	273	237	36	63	224	261	114

Model SGM7A-	Flange Dimensions							Shaft End Dimensions		Approx. Mass [kg]
	LA	LB	LC	LE	LG	LH	LZ	S	Q	
30A□A21	145	110 ⁰ _{-0.035}	130	6	12	165	9	28 ⁰ _{-0.013}	55	10.5
40A□A21	145	110 ⁰ _{-0.035}	130	6	12	165	9	28 ⁰ _{-0.013}	55	13.5
50A□A21	145	110 ⁰ _{-0.035}	130	6	12	165	9	28 ⁰ _{-0.013}	55	16.5

* For models that have a batteryless absolute encoder, L, LL, LP, and KB2 are 8 mm greater than the given value. Refer to the following section for the values for individual models.

🔗 **Dimensions of Servomotors with Batteryless Absolute Encoders on page 5-31**

Note: 1. The dimensions are same for models with oil seals.

2. The values for a straight, without key specification are given. Refer to the information given below for other shaft end specifications and option specifications.

◆ Shaft End Specifications

- Straight with Key and Tap

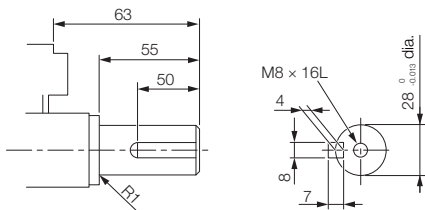

◆ Connector Specifications

- Encoder Connector (24-bit Encoder)

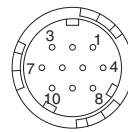

1	PS	6*	BAT(+)
2	/PS	7	-
3	-	8	-
4	PG5V	9	PG0V
5*	BAT(-)	10	FG (frame ground)

* A battery is required only for an absolute encoder.

Receptacle: CM10-R10P-D

Applicable plug: Not provided by Yaskawa.

Plug: CM10-AP10S-□-D for Right-angle Plug
CM10-SP10S-□-D for Straight Plug

(□ depends on the applicable cable size.)

Manufacturer: DDK Ltd.

- Servomotor Connector

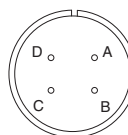

A	Phase U	C	Phase W
B	Phase V	D	FG (frame ground)

Manufacturer: DDK Ltd.

SGM7A-70

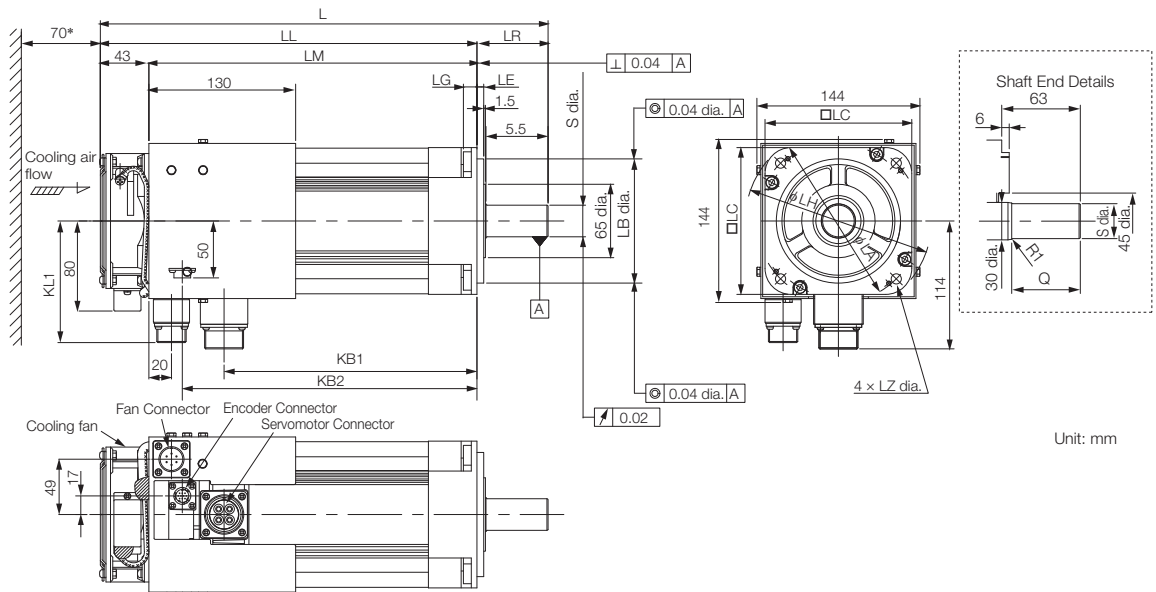

* Leave a minimum space of 70 mm around the Servomotor from walls and other equipment to allow for a sufficient amount of cooling air.

Model SGM7A-	L	LL	LM	LR	KB1	KB2*	KL1	Flange Dimensions						Shaft End Dimensions		Approx. Mass [kg]	
								LA	LB	LC	LE	LG	LH	LZ	S		Q
70A□A21	397	334	291	63	224	261	108	145	110 ⁰ _{-0.035}	130	6	12	165	9	28 ⁰ _{-0.013}	55	18.5

* For models that have a batteryless absolute encoder, KB is 8 mm greater than the given value. Refer to the following section for the values for individual models.

Dimensions of Servomotors with Batteryless Absolute Encoders on page 5-31

Note: 1. The dimensions are same for models with oil seals.

2. The values for a straight, without key specification are given. Refer to the information given below for other shaft end specifications and option specifications.

◆ Cooling Fan Specifications

Single-phase, 220 V
50/60 Hz
17/15 W
0.11/0.09 A

◆ Specifications of Fan Operation Error Detector

Contact Capacity

Maximum allowable voltage: 350 V (AC/DC)
Maximum allowable current: 120 mA (AC/ DC)
Maximum controllable power: 360 mW

Alarm Contacts

ON for normal fan rotation.
OFF at 1,680 ± 100 min⁻¹ max.
OFF for 3 seconds at startup.

◆ Shaft End Specifications

- Straight with Key and Tap

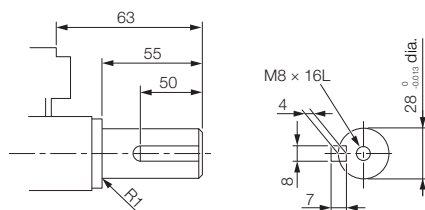

◆ Connector Specifications

- Encoder Connector (24-bit Encoder)

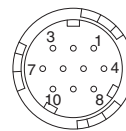

1	PS	6*	BAT(+)
2	/PS	7	-
3	-	8	-
4	PG5V	9	PG0V
5*	BAT(-)	10	FG (frame ground)

* A battery is required only for an absolute encoder.
Receptacle: CM10-R10P-D
Applicable plug: Not provided by Yaskawa.
Plug: CM10-AP10S-□-D for Right-angle Plug
CM10-SP10S-□-D for Straight Plug
(□ depends on the applicable cable size.)
Manufacturer: DDK Ltd.

- Servomotor Connector

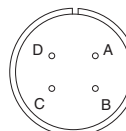

A	Phase U	C	Phase W
B	Phase V	D	FG (frame ground)

Manufacturer: DDK Ltd.

- Fan Connector

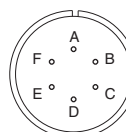

A	Fan motor	D	Alarm pin
B	Fan motor	E	Alarm pin
C	-	F	FG (frame ground)

Receptacle: MS3102A14S-6P
Applicable Plug (Available from Yaskawa Controls Co., Ltd.)
Plug: MS3108B14S-6S
Cable Clamp: MS3057-6A

Note: The Servomotor Connector (receptacle) is RoHS compliant. Contact the connector manufacturer for RoHS-compliant cable-side connectors (not provided by Yaskawa).

5.3.3 Servomotors without Gears and with Holding Brakes

SGM7A-15 to -25

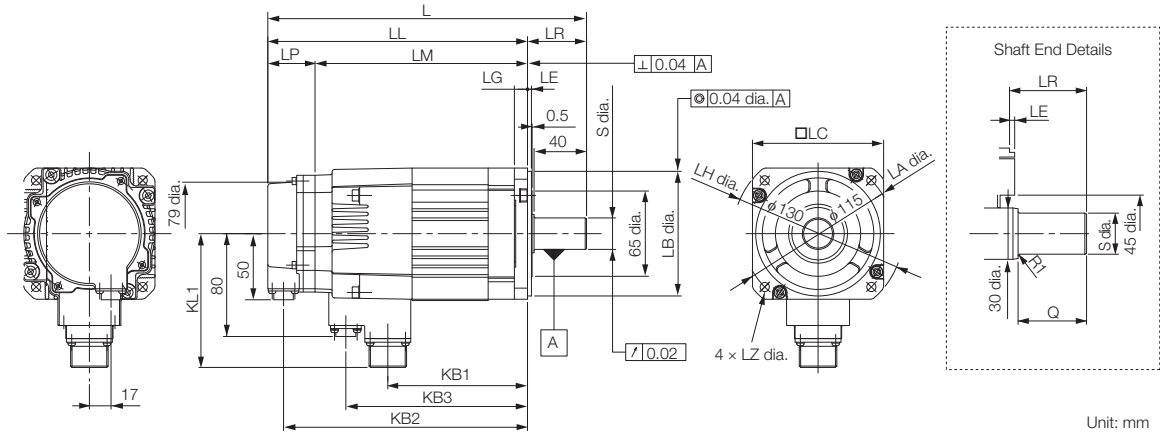

Model SGM7A-	L*	LL*	LM	LP*	LR	KB1	KB2*	KB3	KL1
15A□A2C	243	198	162	36	45	107	186	139	102
20A□A2C	259	214	178	36	45	123	202	155	102
25A□A2C	292	247	211	36	45	156	235	188	102

Model SGM7A-	Flange Dimensions							Shaft End Dimensions		Approx. Mass [kg]
	LA	LB	LC	LE	LG	LH	LZ	S	Q	
15A□A2C	115	95 ⁰ _{-0.035}	100	3	10	130	7	24 ⁰ _{-0.013}	40	6.0
20A□A2C	115	95 ⁰ _{-0.035}	100	3	10	130	7	24 ⁰ _{-0.013}	40	6.8
25A□A2C	115	95 ⁰ _{-0.035}	100	3	10	130	7	24 ⁰ _{-0.013}	40	8.7

* For models that have a batteryless absolute encoder, L, LL, LP, and KB2 are 8 mm greater than the given value. Refer to the following section for the values for individual models.

Dimensions of Servomotors with Batteryless Absolute Encoders on page 5-31

Note: 1. The dimensions are same for models with oil seals.

2. The values for a straight, without key specification are given. Refer to the information given below for other shaft end specifications and option specifications.

◆ Shaft End Specifications

- Straight with Key and Tap

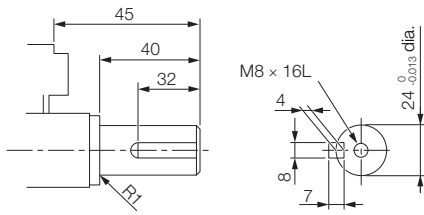

◆ Connector Specifications

- Encoder Connector (24-bit Encoder)

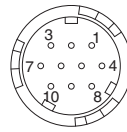

1	PS	6*	BAT(+)
2	/PS	7	-
3	-	8	-
4	PG5V	9	PG0V
5*	BAT(-)	10	FG (frame ground)

* A battery is required only for an absolute encoder.
 Receptacle: CM10-R10P-D
 Applicable plug: Not provided by Yaskawa.
 Plug: CM10-AP10S-□-D for Right-angle Plug
 CM10-SP10S-□-D for Straight Plug
 (□ depends on the applicable cable size.)
 Manufacturer: DDK Ltd.

- Servomotor Connector

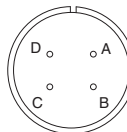

A	Phase U	C	Phase W
B	Phase V	D	FG (frame ground)

Manufacturer: DDK Ltd.

- Brake Connector

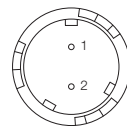

1	Brake terminal
2	Brake terminal

Note: There is no voltage polarity for the brake terminals.
 Receptacle: CM10-R2P-D
 Applicable plug: Not provided by Yaskawa.
 Plug: CM10-AP2S-□-D for Right-angle Plug
 CM10-SP2S-□-D for Straight Plug
 (□ depends on the applicable cable size.)
 Manufacturer: DDK Ltd.

SGM7A-30 to -50

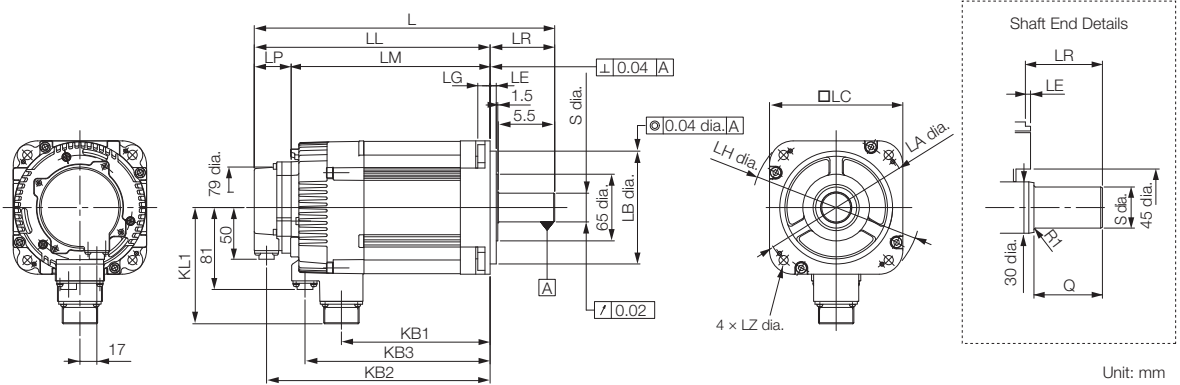

Model SGM7A-	L*	LL*	LM	LP*	LR	KB1	KB2*	KB3	KL1
30A□A2C	293	232	196	36	63	145	220	181	119
40A□A2C	332	269	233	36	63	184	257	220	119
50A□A2C	372	309	273	36	63	224	297	260	119

Model SGM7A-	Flange Dimensions							Shaft End Dimensions		Approx. Mass [kg]
	LA	LB	LC	LE	LG	LH	LZ	S	Q	
30A□A2C	145	110 ⁰ _{-0.035}	130	6	12	165	9	28 ⁰ _{-0.013}	55	13
40A□A2C	145	110 ⁰ _{-0.035}	130	6	12	165	9	28 ⁰ _{-0.013}	55	16
50A□A2C	145	110 ⁰ _{-0.035}	130	6	12	165	9	28 ⁰ _{-0.013}	55	19

* For models that have a batteryless absolute encoder, L, LL, LP, and KB2 are 8 mm greater than the given value. Refer to the following section for the values for individual models.

Dimensions of Servomotors with Batteryless Absolute Encoders on page 5-31

Note: 1. The dimensions are same for models with oil seals.

2. The values for a straight, without key specification are given. Refer to the information given below for other shaft end specifications and option specifications.

◆ Shaft End Specifications

- Straight with Key and Tap

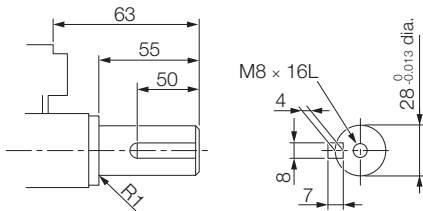

◆ Connector Specifications

- Encoder Connector (24-bit Encoder)

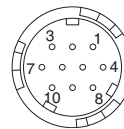

1	PS	6*	BAT(+)
2	/PS	7	-
3	-	8	-
4	PG5V	9	PG0V
5*	BAT(-)	10	FG (frame ground)

* A battery is required only for an absolute encoder.

Receptacle: CM10-R10P-D

Applicable plug: Not provided by Yaskawa.

Plug: CM10-AP10S-□-D for Right-angle Plug

CM10-SP10S-□-D for Straight Plug

(□ depends on the applicable cable size.)

Manufacturer: DDK Ltd.

- Servomotor Connector

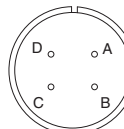

A	Phase U	C	Phase W
B	Phase V	D	FG (frame ground)

Manufacturer: DDK Ltd.

- Brake Connector

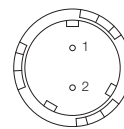

1	Brake terminal
2	Brake terminal

Note: There is no voltage polarity for the brake terminals.

Receptacle: CM10-R2P-D

Applicable plug: Not provided by Yaskawa.

Plug: CM10-AP2S-□-D for Right-angle Plug

CM10-SP2S-□-D for Straight Plug

(□ depends on the applicable cable size.)

Manufacturer: DDK Ltd.

5.3.4 Servomotors with Gears

SGM7A-A5, -01, and -C2

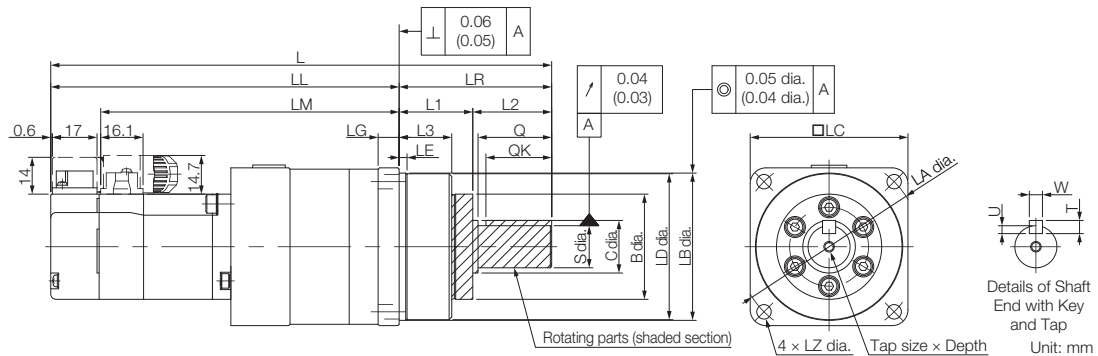

Model SGM7A-	Gear Ratio	L*	LL*	LM	Flange Dimensions								
					LR	LE	LG	B	LD	LB	LC	LA	LZ
A5A□AH1□□	1/5	138	96	77.4	42	2.2	5	29	39.5	40 ⁰ _{-0.025}	40	46	3.4
A5A□AH2□□	1/9	(178.5)	(136.5)										
A5A□AHC□□	1/21	147	105	86.4	58	2.5	8	40	55.5	56 ⁰ _{-0.030}	60	70	5.5
A5A□AH7□□	1/33	(187.5)	(145.5)	(219)									
01A□AH1□□	1/5	150	108	89.4	42	2.2	5	29	39.5	40 ⁰ _{-0.025}	40	46	3.4
01A□AHB□□	1/11	190.5	132.5	113.9	58	2.5	8	40	55.5	56 ⁰ _{-0.030}	60	70	5.5
01A□AHC□□	1/21	(231)	(173)										
01A□AH7□□	1/33	215	135	116.4	80	7.5	10	59	84	85 ⁰ _{-0.035}	90	105	9
C2A□AH1□□	1/5	162	120	101.4	42	2.2	5	29	39.5	40 ⁰ _{-0.025}	40	46	3.4
C2A□AHB□□	1/11	202.5	144.5	125.9	58	2.5	8	40	55.5	56 ⁰ _{-0.030}	60	70	5.5
C2A□AHC□□	1/21	227	147	128.4	80	7.5	10	59	84	85 ⁰ _{-0.035}	90	105	9
C2A□AH7□□	1/33	(275)	(195)										

Model SGM7A-	Flange Dimensions			Q	C	S	Tap Size × Depth	Key Dimensions				Approx. Mass [kg]
	L1	L2	L3					QK	U	W	T	
A5A□AH1□□	22	20	14.6	-	-	10 ⁰ _{-0.015}	M3 × 6L	15	2.5	4	4	0.6
A5A□AH2□□												(0.9)
A5A□AHC□□												0.7
A5A□AH7□□	28	30	20	28	20	16 ⁰ _{-0.018}	M4 × 8L	25	3	5	5	1.3
01A□AH1□□	22	20	14.6	-	-	10 ⁰ _{-0.015}	M3 × 6L	15	2.5	4	4	0.7
01A□AHB□□	28	30	20	28	20	16 ⁰ _{-0.018}	M4 × 8L	25	3	5	5	1.4
01A□AHC□□												(1.7)
01A□AH7□□	36	44	26	42	32	25 ⁰ _{-0.021}	M6 × 12L	36	4	8	7	2.8
C2A□AH1□□	22	20	14.6	-	-	10 ⁰ _{-0.015}	M3 × 6L	15	2.5	4	4	0.8
C2A□AHB□□	28	30	20	28	20	16 ⁰ _{-0.018}	M4 × 8L	25	3	5	5	1.5
C2A□AHC□□	36	44	26	42	32	25 ⁰ _{-0.021}	M6 × 12L	36	4	8	7	2.9
C2A□AH7□□												(3.2)

* For models that have a batteryless absolute encoder, L and LL are 8 mm greater than the given value. Refer to the following section for the values for individual models.

Dimensions of Servomotors with Batteryless Absolute Encoders on page 5-31

5.3 External Dimensions

5.3.4 Servomotors with Gears

- Note: 1. The values in parentheses are for Servomotors with Holding Brakes.
 2. Gear dimensions are different from those of the Σ, Σ-II, and Σ-III Series.
 3. The values for the shaft end are for a straight shaft with key and tap. If a key and tap are not necessary, specify shaft end code 2 for the 8th digit.

◆ Flange Output Face

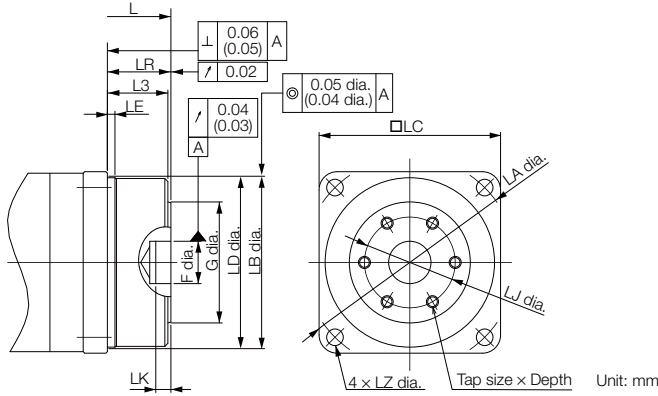

Note: The geometric tolerance in parentheses is the value for LC = 40.

Model SGM7A-	Gear Ratio	L*	LR	LJ	F	G	LK	No. of Taps × Tap Size × Depth	Approx. Mass [kg]		
A5A□AH10□	1/5	111	15	18	5 ^{+0.012} ₀	24	3	3 × M4 × 6L	0.6 (0.9)		
A5A□AH20□	1/9	(151.5)									
A5A□AHC0□	1/21	120 (160.5)									
A5A□AH70□	1/33	141.5 (182)	21	30	14 ^{+0.018} ₀	40	5	6 × M4 × 7L	1.2 (1.5)		
01A□AH10□	1/5	123 (163.5)	15	18	5 ^{+0.012} ₀	24	5	3 × M4 × 6L	0.7 (1.0)		
01A□AHB0□	1/11	153.5 (194)	21	30	14 ^{+0.018} ₀	40				3 × M4 × 7L	1.3 (1.6)
01A□AHC0□	1/21										
01A□AH70□	1/33	162 (202.5)	27	45	24 ^{+0.021} ₀	59	6 × M6 × 10L	2.4 (2.7)			
C2A□AH10□	1/5	135 (183)	15	18	5 ^{+0.012} ₀	24	3	3 × M4 × 6L	0.8 (1.1)		
C2A□AHB0□	1/11	165.5 (213.5)	21	30	14 ^{+0.018} ₀	40	5	6 × M4 × 7L	1.4 (1.7)		
C2A□AHC0□	1/21	174 (222)	27	45	24 ^{+0.021} ₀	59	5	6 × M6 × 10L	2.5 (2.8)		
C2A□AH70□	1/33										

* For models that have a batteryless absolute encoder, L is 8 mm greater than the given value. Refer to the following section for the values for individual models.

Dimensions of Servomotors with Batteryless Absolute Encoders on page 5-31

- Note: 1. The values in parentheses are for Servomotors with Holding Brakes.
 2. Dimensions not found in the above table are the same as those in the table on the previous page.

Important

For a Servomotor with a flange output that has square gear flange dimensions (□LC) of 40 mm, we recommend that you design the Servomotor with the dimensions shown in the following figure in order to secure a gap between the gear oil seal and the connecting parts on the load side.

SGM7A-02, -04, and -06

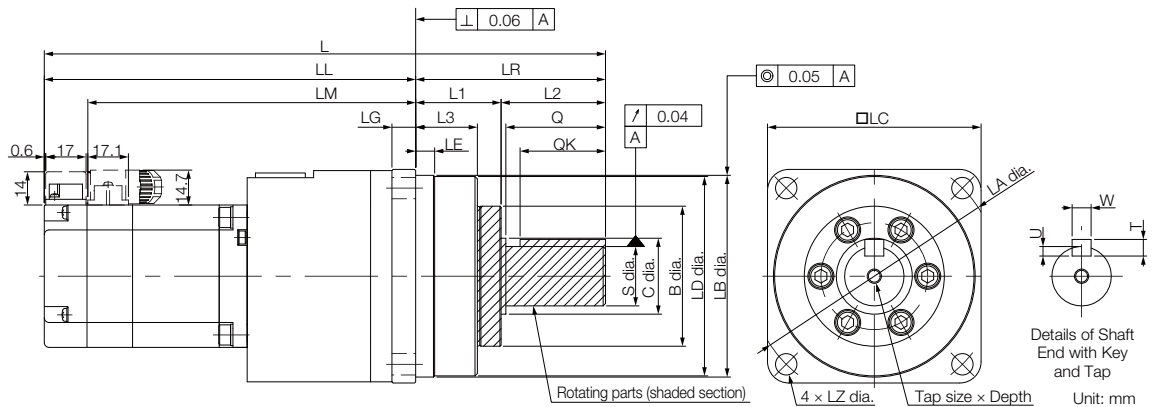

Model SGM7A-	Gear Ratio	L*	LL*	LM	Flange Dimensions									
					LR	LE	LG	B	LD	LB	LC	LA	LZ	
02A□AH1□□	1/5	191.5	133.5	115.2	58	2.5	8	40	55.5	56 ⁰ _{-0.030}	60	70	5.5	
02A□AHB□□	1/11	(232)	(174)											
02A□AHC□□	1/21	220.5	140.5	122.2	80	7.5	10	59	84	85 ⁰ _{-0.035}	90	105	9	
02A□AH7□□	1/33	(261)	(181)											
04A□AH1□□	1/5	207.5	149.5	131.2	58	2.5	8	40	55.5	56 ⁰ _{-0.030}	60	70	5.5	
04A□AHB□□	1/11	236.5	156.5	138.2	80	7.5	10	59	84	85 ⁰ _{-0.035}	90	105	9	
04A□AHC□□	1/21	(277)	(197)											
04A□AH7□□	1/33	322.5	189.5	171.2	133	12.5	13	84	114	115 ⁰ _{-0.035}	120	135	11	
06A□AH1□□	1/5	258.5	178.5	160.2	80	7.5	10	59	84	85 ⁰ _{-0.035}	90	105	9	
06A□AHB□□	1/11	(312.5)	(232.5)											
06A□AHC□□	1/21	344.5	211.5	193.2	133	12.5	13	84	114	115 ⁰ _{-0.035}	120	135	11	
06A□AH7□□	1/33	(398.5)	(265.5)											

Model SGM7A-	Flange Dimensions			Q	C	S	Tap Size × Depth	Key Dimensions				Approx. Mass [kg]
	L1	L2	L3					QK	U	W	T	
02A□AH1□□	28	30	20	28	20	16 ⁰ _{-0.018}	M4 × 8L	25	3	5	5	1.8
02A□AHB□□												2.4
02A□AHC□□	36	44	26	42	32	25 ⁰ _{-0.021}	M6 × 12L	36	4	8	7	3.7
02A□AH7□□												4.3
04A□AH1□□	28	30	20	28	20	16 ⁰ _{-0.018}	M4 × 8L	25	3	5	5	2.1
04A□AHB□□												2.7
04A□AHC□□	36	44	26	42	32	25 ⁰ _{-0.021}	M6 × 12L	36	4	8	7	4.0
04A□AH7□□												4.6
04A□AH7□□	48	85	33	82	44	40 ⁰ _{-0.025}	M10 × 20L	70	5	12	8	8.6
06A□AH1□□	36	44	26	42	32	25 ⁰ _{-0.021}	M6 × 12L	36	4	8	7	4.3
06A□AHB□□												4.9
06A□AHC□□	48	85	33	82	44	40 ⁰ _{-0.025}	M10 × 20L	70	5	12	8	9.1
06A□AH7□□												9.7

* For models that have a batteryless absolute encoder, L and LL are 8 mm greater than the given value. Refer to the following section for the values for individual models.

Dimensions of Servomotors with Batteryless Absolute Encoders on page 5-31

Note: 1. The values in parentheses are for Servomotors with Holding Brakes.

2. Gear dimensions are different from those of the Σ, Σ-II, and Σ-III Series.

3. The values for the shaft end are for a straight shaft with key and tap. If a key and tap are not necessary, specify shaft end code 2 for the 8th digit.

◆ Flange Output Face

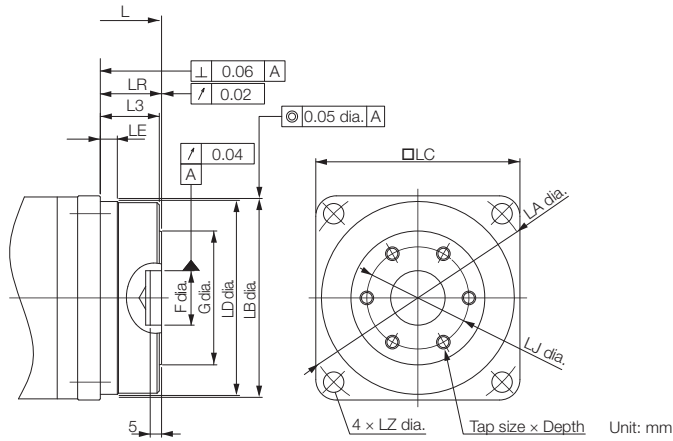

Model SGM7A-	Gear Ratio	L*	LR	LJ	F	G	No. of Taps × Tap Size × Depth	Approx. Mass [kg]
02A□AH10□	1/5	154.5 (195)	21	30	14 ^{+0.018} ₀	40	6 × M4 × 7L	1.7 (2.3)
02A□AHB0□	1/11							1.8 (2.4)
02A□AHC0□	1/21	167.5 (208)	27	45	24 ^{+0.021} ₀	59	6 × M6 × 10L	3.3 (3.9)
02A□AH70□	1/33							
04A□AH10□	1/5	170.5 (211)	21	30	14 ^{+0.018} ₀	40	6 × M4 × 7L	2.0 (2.6)
04A□AHB0□	1/11							
04A□AHC0□	1/21	183.5 (224)	27	45	24 ^{+0.021} ₀	59	6 × M6 × 10L	3.6 (4.2)
04A□AH70□	1/33							
04A□AH70□	1/33	224.5 (265)	35	60	32 ^{+0.025} ₀	84	6 × M8 × 12L	7.2 (7.8)
06A□AH10□	1/5	205.5 (259.5)	27	45	24 ^{+0.021} ₀	59	6 × M6 × 10L	3.9 (4.5)
06A□AHB0□	1/11							4.1 (4.7)
06A□AHC0□	1/21	246.5 (300.5)	35	60	32 ^{+0.025} ₀	84	6 × M8 × 12L	7.7 (8.3)
06A□AH70□	1/33							

* For models that have a batteryless absolute encoder, L is 8 mm greater than the given value. Refer to the following section for the values for individual models.

 Dimensions of Servomotors with Batteryless Absolute Encoders on page 5-31

Note: 1. The values in parentheses are for Servomotors with Holding Brakes.

2. Dimensions not found in the above table are the same as those in the table on the previous page.

SGM7A-08 and -10

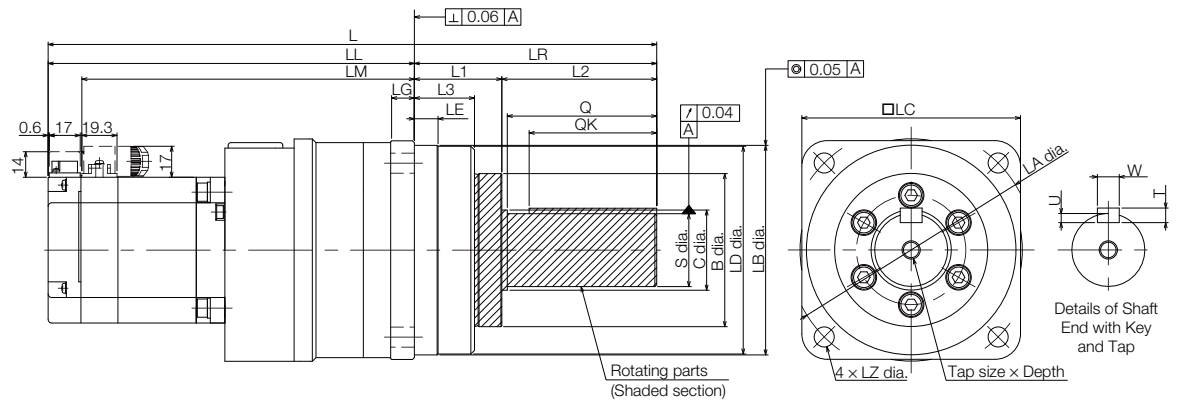

Unit: mm

Model SGM7A-	Gear Ratio	L*	LL*	LM	Flange Dimensions								
					LR	LE	LG	B	LD	LB	LC	LA	LZ
08A□AH1□□	1/5	255	175	156.5	80	7.5	10	59	84	85 ⁰ _{-0.035}	90	105	9
08A□AHB□□	1/11	(302)	(222)										
08A□AHC□□	1/21	334	201	182.5	133	12.5	13	84	114	115 ⁰ _{-0.035}	120	135	11
08A□AH7□□	1/33												
10A□AH1□□	1/5	280	200	181.5	80	7.5	10	59	84	85 ⁰ _{-0.035}	90	105	9
10A□AHB□□	1/11	(327)	(247)										
10A□AHC□□	1/21	359	226	207.5	133	12.5	13	84	114	115 ⁰ _{-0.035}	120	135	11
10A□AH7□□	1/33												

Model SGM7A-	Flange Dimensions			Q	C	S	Tap Size × Depth	Key Dimensions				Approx. Mass* [kg]
	L1	L2	L3					QK	U	W	T	
08A□AH1□□	36	44	26	42	32	25 ⁰ _{-0.021}	M6 × 12L	36	4	8	7	4.9 (5.8)
08A□AHB□□												5.1 (6.0)
08A□AHC□□	48	85	33	82	44	40 ⁰ _{-0.025}	M10 × 20L	70	5	12	8	9.8 (10.7)
08A□AH7□□												
10A□AH1□□	36	44	26	42	32	25 ⁰ _{-0.021}	M6 × 12L	36	4	8	7	6.0 (6.6)
10A□AHB□□												
10A□AHC□□	48	85	33	82	44	40 ⁰ _{-0.025}	M10 × 20L	70	5	12	8	10.9 (11.5)
10A□AH7□□												

* For models that have a batteryless absolute encoder, L and LL are 8 mm greater and the approximate mass is 0.1 kg greater than the given value. Refer to the following section for the values for individual models.

Dimensions of Servomotors with Batteryless Absolute Encoders on page 5-31

Note: 1. The values in parentheses are for Servomotors with Holding Brakes.

2. Gear dimensions are different from those of the Σ, Σ-II, and Σ-III Series.

3. The values for the shaft end are for a straight shaft with key and tap. If a key and tap are not necessary, specify shaft end code 2 for the 8th digit.

◆ Flange Output Face

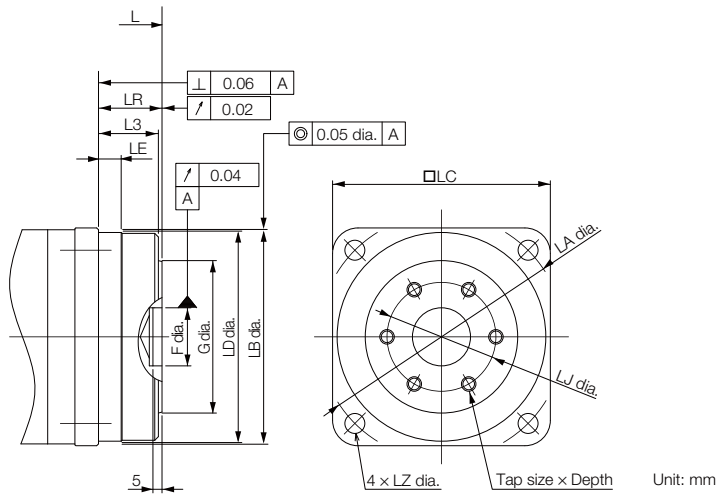

Model SGM7A-	Gear Ratio	L*	LR	LJ	F	G	No. of Taps × Tap Size × Depth	Approx. Mass* [kg]
08A□AH10□	1/5	202 (249)	27	45	24 ^{+0.021} ₀	59	6 × M6 × 10L	4.7 (5.3)
08A□AHB0□	1/11							4.9 (5.5)
08A□AHC0□	1/21	236 (283)	35	60	32 ^{+0.025} ₀	84	6 × M8 × 12L	8.6 (9.2)
08A□AH70□	1/33							
10A□AH10□	1/5	227 (274)	27	45	24 ^{+0.021} ₀	59	6 × M6 × 10L	5.6 (6.3)
10A□AHB0□	1/11							
10A□AHC0□	1/21	261 (308)	35	60	32 ^{+0.025} ₀	84	6 × M8 × 12L	9.5 (10.1)
10A□AH70□	1/33							

* For models that have a batteryless absolute encoder, L is 8 mm greater and the approximate mass is 0.1 kg greater than the given value. Refer to the following section for the values for individual models.

 **Dimensions of Servomotors with Batteryless Absolute Encoders on page 5-31**

Note: 1. The values in parentheses are for Servomotors with Holding Brakes.

2. Dimensions not found in the above table are the same as those in the table on the previous page.

Dimensions of Servomotors with Batteryless Absolute Encoders

◆ Servomotors without Gears

Model SGM7A-	L	LL	LP	KB2	Approx. Mass [kg]
A5A6A2□	89.5 (130)	64.5 (105)	–	–	0.3 (0.6)
01A6A2□	101.5 (142)	76.5 (117)	–	–	0.4 (0.7)
C2A6A2□	113.5 (161.5)	88.5 (136.5)	–	–	0.5 (0.8)
02A6A2□	107.5 (148)	77.5 (118)	–	–	0.8 (1.4)
04A6A2□	123.5 (164)	93.5 (134)	–	–	1.2 (1.8)
06A6A2□	145.5 (199.5)	115.5 (169.5)	–	–	1.6 (2.2)
08A6A2□	145 (192)	105 (152)	–	–	2.4 (3.0)
10A6A2□	170 (217)	130 (177)	–	–	3.2 (3.8)
15A6A2□	210 (251)	165 (206)	44 (44)	153 (194)	4.6 (6.0)
20A6A2□	226 (267)	181 (222)	44 (44)	169 (210)	5.4 (6.8)
25A6A2□	249 (300)	204 (255)	44 (44)	192 (243)	6.8 (8.7)
30A6A2□	265 (301)	202 (240)	44 (44)	190 (228)	10.5 (13)
40A6A2□	304 (340)	241 (277)	44 (44)	229 (265)	13.5 (16)
50A6A2□	344 (380)	281 (317)	44 (44)	269 (305)	16.5 (19)
70A6A2□	397	334	–	269	18.5

Note: The values in parentheses are for Servomotors with Holding Brakes.

◆ Servomotors with Gears

• Shaft End Specification: Straight

Model SGM7A-	L	LL	Approx. Mass [kg]
A5A6AH1□□	146	104	0.6
A5A6AH2□□	(186.5)	(144.5)	(0.9)
A5A6AHC□□	155 (195.5)	113 (153.5)	0.7 (1.7)
A5A6AH7□□	186.5 (227)	128.5 (169)	1.3 (1.6)
01A6AH1□□	158 (198.5)	116 (156.5)	0.7 (1.0)
01A6AHB□□	198.5 (239)	140.5 (181)	1.4 (1.7)
01A6AHC□□			
01A6AH7□□	223 (263.5)	143 (183.5)	2.8 (3.1)
C2A6AH1□□	170 (218)	128 (176)	0.8 (1.1)
C2A6AHB□□	210.5 (258.5)	152.5 (200.5)	1.5 (1.8)
C2A6AHC□□	235 (283)	155 (203)	2.9 (3.2)
C2A6AH7□□			
02A6AH1□□	199.5 (240)	141.5 (182)	1.8 (2.4)
02A6AHB□□			1.9 (2.5)
02A6AHC□□	228.5 (269)	148.5 (189)	3.7 (4.3)
02A6AH7□□			
04A6AH1□□	215.5 (256)	157.5 (198)	2.1 (2.7)
04A6AHB□□	244.5 (285)	164.5 (205)	4.0 (4.6)
04A6AHC□□			
04A6AH7□□	330.5 (371)	197.5 (238)	8.6 (9.2)
06A6AH1□□	266.5 (320.5)	186.5 (240.5)	4.3 (4.9)
06A6AHB□□			4.5 (5.1)
06A6AHC□□	352.5 (406.5)	219.5 (273.5)	9.1 (9.7)
06A6AH7□□			
08A6AH1□□	263 (310)	183 (230)	5.0 (5.9)
08A6AHB□□			5.2 (6.1)
08A6AHC□□	342 (389)	209 (256)	9.9 (10.8)
08A6AH7□□			
10A6AH1□□	288 (335)	208 (255)	6.1 (6.7)
10A6AHB□□	367 (414)	234 (281)	11.0 (11.6)
10A6AHC□□			
10A6AH7□□			

• Shaft End Specification: Flange Output

Model SGM7A-	L	Approx. Mass [kg]
A5A6AH10□	119	0.6 (0.9)
A5A6AH20□	(159.5)	
A5A6AHC0□	128 (168.5)	
A5A6AH70□	149.5 (190)	1.2 (1.5)
01A6AH10□	131 (171.5)	0.7 (1.0)
01A6AHB0□	161.5 (202)	1.3 (1.6)
01A6AHC0□		
01A6AH70□	170 (210.5)	2.4 (2.7)
C2A6AH10□	143 (191)	0.8 (1.1)
C2A6AHB0□	173.5 (221.5)	1.4 (1.7)
C2A6AHC0□	182 (230)	2.5 (2.8)
C2A6AH70□		
02A6AH10□	162.5 (203)	1.7 (2.3)
02A6AHB0□		1.8 (2.4)
02A6AHC0□	175.5 (216)	3.3 (3.9)
02A6AH70□		
04A6AH10□	178.5 (219)	2.0 (2.6)
04A6AHB0□	191.5 (232)	3.6 (4.2)
04A6AHC0□		
04A6AH70□	232.5 (273)	7.2 (7.8)
06A6AH10□	213.5 (267.5)	3.9 (4.5)
06A6AHB0□		4.1 (4.7)
06A6AHC0□	254.5 (308.5)	7.7 (8.3)
06A6AH70□		
08A6AH10□	210 (257)	4.8 (5.4)
08A6AHB0□		5.0 (5.6)
08A6AHC0□	244 (291)	8.7 (9.3)
08A6AH70□		
10A6AH10□	235 (282)	5.7 (6.4)
10A6AHB0□	269 (316)	9.6 (10.2)
10A6AHC0□		
10A6AH70□		

Note: The values in parentheses are for Servomotors with Holding Brakes.

Specifications, Ratings, and External Dimensions of SGM7P Servomotors

6

This chapter describes how to interpret the model numbers of SGM7P Servomotors and gives their specifications, ratings, and external dimensions.

6.1	Model Designations	6-2
6.1.1	Without Gears	6-2
6.1.2	With Gears	6-2
6.2	Specifications and Ratings	6-3
6.2.1	Specifications	6-3
6.2.2	Ratings of Servomotors without Gears	6-4
6.2.3	Torque-Motor Speed Characteristics	6-5
6.2.4	Ratings of Servomotors with Gears	6-6
6.2.5	Servomotor Overload Protection Characteristics	6-8
6.2.6	Allowable Load Moment of Inertia	6-8
6.2.7	Derating Rates	6-9
6.3	External Dimensions	6-11
6.3.1	Servomotors without Gears	6-11
6.3.2	Servomotors with Gears	6-13

6.1 Model Designations

6.1.1 Without Gears

SGM7P - 01 A 7 A 2 1

Σ-7 Series
Servomotors:
SGM7P

1st+2nd
digits

3rd
digit

4th
digit

5th
digit

6th
digit

7th
digit

1st+2nd digits Rated Output

Code	Specification
01	100 W
02	200 W
04	400 W
08	750 W
15	1.5 kW

3rd digit Power Supply Voltage

Code	Specification
A	200 VAC

4th digit Serial Encoder

Code	Specification
6	24-bit batteryless absolute
7	24-bit absolute
F	24-bit incremental

5th digit Design Revision Order

Code	Specification
A	IP65
E	IP67

6th digit Shaft End

Code	Specification
2	Straight without key
6	Straight with key and tap

7th digit Options

Code	Specification
1	Without options
C	With holding brake (24 VDC)
E	With oil seal and holding brake (24 VDC)
S	With oil seal

6.1.2 With Gears

SGM7P - 01 A 7 A H B 0 1

Σ-7 Series
Servomotors:
SGM7P

1st+2nd
digits

3rd
digit

4th
digit

5th
digit

6th
digit

7th
digit

8th
digit

9th
digit

1st+2nd digits Rated Output

Code	Specification
01	100 W
02	200 W
04	400 W
08	750 W
15	1.5 kW

3rd digit Power Supply Voltage

Code	Specification
A	200 VAC

4th digit Serial Encoder

Code	Specification
6	24-bit batteryless absolute
7	24-bit absolute
F	24-bit incremental

5th digit Design Revision Order

Code	Specification
A	IP55

6th digit Gear Type

Code	Specification
H	HDS planetary low-backlash gear

7th digit Gear Ratio

Code	Specification
B	1/11
C	1/21
1	1/5
7	1/33

8th digit Shaft End

Code	Specification
0	Flange output
2	Straight without key
6	Straight with key and tap

9th digit Options

Code	Specification
1	Without options
C	With holding brake (24 VDC)

6.2 Specifications and Ratings

6.2.1 Specifications

Voltage		200 V				
Model SGM7P-		01A	02A	04A	08A	15A
Time Rating		Continuous				
Thermal Class		UL: B, CE: B				
Insulation Resistance		500 VDC, 10 M Ω min.				
Withstand Voltage		1,500 VAC for 1 minute				
Excitation		Permanent magnet				
Mounting		Flange-mounted				
Drive Method		Direct drive				
Rotation Direction		Counterclockwise (CCW) for forward reference when viewed from the load side				
Vibration Class* ¹		V15				
Environmental Conditions	Surrounding Air Temperature	0°C to 40°C (With derating, usage is possible between 40°C and 60°C.)* ³				
	Surrounding Air Humidity	20% to 80% relative humidity (with no condensation)				
	Installation Site	<ul style="list-style-type: none"> • Must be indoors and free of corrosive and explosive gases. • Must be well-ventilated and free of dust and moisture. • Must facilitate inspection and cleaning. • Must have an altitude of 1,000 m or less. (With derating, usage is possible between 1,000 m and 2,000 m.)*³ • Must be free of strong magnetic fields. 				
	Storage Environment	Store the Servomotor in the following environment if you store it with the power cable disconnected. Storage temperature: -20°C to 60°C (with no freezing) Storage humidity: 20% to 80% relative humidity (with no condensation)				
Shock Resistance* ²	Impact Acceleration Rate at Flange	490 m/s ²				
	Number of Impacts	2 times				
Vibration Resistance* ²	Vibration Acceleration Rate at Flange	49 m/s ²				
Applicable SERVOPACKs	SGD7S-	R90A, R90F	2R8A, 2R1F	2R8A, 2R8F	5R5A	120A
	SGD7W-SGD7C-	1R6A* ⁴ , 2R8A* ⁴	2R8A, 5R5A* ⁴ , 7R6A* ⁴		5R5A, 7R6A	—

*1. A vibration class of V15 indicates a vibration amplitude of 15 μm maximum on the Servomotor without a load at the rated motor speed.

*2. The given values are for when the Servomotor shaft is mounted horizontally and shock or vibration is applied in the directions shown in the following figures.

The strength of the vibration that the Servomotor can withstand depends on the application. Always check the vibration acceleration rate that is applied to the Servomotor with the actual equipment.

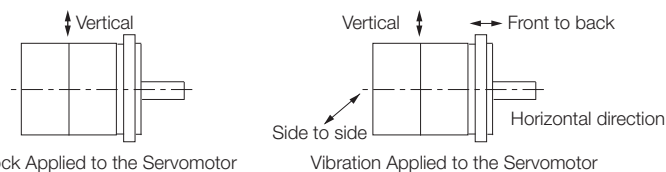

*3. Refer to the following section for the derating rates.

 [6.2.7 Derating Rates](#) on page 6-9

*4. If you use the Servomotor together with a Σ -7W or Σ -7C SERVOPACK, the control gain may not increase as much as with a Σ -7S SERVOPACK and other performances may be lower than those achieved with a Σ -7S SERVOPACK.

6.2.2 Ratings of Servomotors without Gears

Voltage		200 V					
Model SGM7P-		01A	02A	04A	08A	15A	
Rated Output* ¹	W	100	200	400	750	1500	
Rated Torque* ^{1, *2}	N·m	0.318	0.637	1.27	2.39	4.77	
Instantaneous Maximum Torque* ¹	N·m	0.955	1.91	3.82	7.16	14.3	
Rated Current* ¹	Arms	0.86	2.0	2.6	5.4	9.2	
Instantaneous Maximum Current* ¹	Arms	2.8	6.4	8.4	16.5	28.0	
Rated Motor Speed* ¹	min ⁻¹	3000					
Maximum Motor Speed* ¹	min ⁻¹	6000					
Torque Constant	N·m/Arms	0.401	0.355	0.524	0.476	0.559	
Motor Moment of Inertia		0.0592	0.263	0.409	2.10	4.02	
	With Holding Brake	×10 ⁻⁴ kg·m ²	0.0892	0.415	0.561	2.98	4.90
	With Batteryless Absolute Encoder		0.0607	0.264	0.410	2.10	4.02
Rated Power Rate* ¹	kW/s	17.1	15.4	39.6	27.2	56.6	
With Holding Brake		11.3	9.7	28.8	19.1	46.4	
Rated Angular Acceleration Rate* ¹	rad/s ²	53700	24200	31100	11400	11900	
With Holding Brake		35600	15300	22600	8020	9730	
Derating Rate for Servomotor with Oil Seal	%	90		95			
Heat Sink Size* ³	mm	250 × 250 × 6			300 × 300 × 12		
Protective Structure* ⁴		Totally enclosed, self-cooled, IP65					
Holding Brake Specifications* ⁵	Rated Voltage	V	24 VDC ±10%				
	Capacity	W	6	7.4		7.5	
	Holding Torque	N·m	0.318	0.637	1.27	2.39	4.77
	Coil Resistance	Ω (at 20°C)	96	84.5		76.8	
	Rated Current	A (at 20°C)	0.25	0.31		0.31	
	Time Required to Release Brake	ms	80				
	Time Required to Brake	ms	100				
Allowable Load Moment of Inertia (Motor Moment of Inertia Ratio)* ⁶		25 times	15 times	10 times	5 times		
	With External Regenerative Resistor and External Dynamic Brake Resistor* ⁷	25 times	15 times	10 times	5 times		
Allowable Shaft Loads* ⁸	LF	mm	20	25		35	
	Allowable Radial Load	N	78	245		392	490
	Allowable Thrust Load	N	49	68		147	

*1. These values are for operation in combination with a SERVOPACK when the temperature of the armature winding is 100°C. The values for other items are at 20°C. These are typical values.

*2. The rated torques are the continuous allowable torque values at a surrounding air temperature of 40°C with an aluminum heat sink of the dimensions given in the table.

*3. Refer to the following section for the relation between the heat sinks and derating rate.

 Servomotor Heat Dissipation Conditions on page 6-9

*4. This does not apply to the shaft opening. Protective structure specifications apply only when the special cable is used.

6.2.4 Ratings of Servomotors with Gears

All models	Gear Mechanism		Protective Structure			Lost Motion [arc-min]				
	Planetary gear mechanism		Totally enclosed, self-cooled, IP55 (except for shaft opening)			3 max.				
Servomotor Model SGM7P-	Servomotor					Gear Output				
	Rated Output [W]	Rated Motor Speed [min ⁻¹]	Maximum Motor Speed [min ⁻¹]	Rated Torque [N·m]	Instantaneous Maximum Torque [N·m]	Gear Ratio	Rated Torque/Efficiency* ¹ [N·m/%]	Instantaneous Maximum Torque [N·m]	Rated Motor Speed [min ⁻¹]	Maximum Motor Speed [min ⁻¹]
01A□AH1□	100	3000	6000	0.318	0.955	1/5	1.05/78* ²	4.30	600	1200
01A□AHB□						1/11	2.52/72	9.30	273	545
01A□AHC□						1/21	5.34/80	18.2	143	286
01A□AH7□						1/33	6.82/65	27.0	91	182
02A□AH1□	200	3000	6000	0.637	1.91	1/5	2.39/75	8.60	600	1200
02A□AHB□						1/11	5.74/82	19.4	273	545
02A□AHC□						1/21	10.2/76	35.9	143	286
02A□AH7□						1/33	17.0/81	57.3	91	182
04A□AH1□	400	3000	6000	1.27	3.82	1/5	5.35/84	17.8	600	1200
04A□AHB□						1/11	11.5/82	38.3	273	545
04A□AHC□						1/21	22.9/86	74.4	143	286
04A□AH7□						1/33	34.0/81	114.6	91	182
08A□AH1□	750	3000	6000	2.39	7.16	1/5	10.0/84	32.8	600	1200
08A□AHB□						1/11	23.1/88	73.6	273	545
08A□AHC□						1/21	42.1/84	138.0	143	286
08A□AH7□						1/33	69.3/88	220	91	182
15A□AH1□	1500	3000	6000	4.77	14.3	1/5	19.1/80	64.8	600	1200
15A□AHB□						1/11	45.6/87	146	273	545
15A□AHC□						1/21	87.1/87	278	143	214* ³
15A□AH7□						1/33	142/90	443	91	136* ³

*1. The gear output torque is expressed by the following formula.

$$\text{Gear output torque} = \text{Servomotor output torque} \times \frac{1}{\text{Gear ratio}} \times \text{Efficiency}$$

The gear efficiency depends on operating conditions such as the output torque, motor speed, and temperature. The values in the table are typical values for the rated torque, rated motor speed, and a surrounding air temperature of 25°C. They are reference values only.

*2. Use the Servomotor at an effective load ratio of 85% or less. The values in the table take the effective load ratio into consideration.

*3. The maximum motor speed calculated at the motor shaft is 4,500 min⁻¹ max.

Note: 1. The gears that are mounted to Yaskawa Servomotors have not been broken in.

Break in the Servomotor if necessary. First, operate the Servomotor at low speed with no load. If no problems occur, gradually increase the speed and load.

2. The no-load torque for a Servomotor with a Gear is high immediately after the Servomotor starts, and it then decreases and becomes stable after a few minutes. This is a common phenomenon caused by grease circulation in the gears and it does not indicate faulty gears.

3. Other specifications are the same as those for Servomotors without Gears.



Important

The SERVOPACK speed control range is 1:5,000. If you use Servomotors at extremely low speeds (0.02 min⁻¹ or lower at the gear output shaft), if you use Servomotors with a one-pulse feed reference for extended periods, or under some other operating conditions, the gear bearing lubrication may be insufficient. That may cause deterioration of the bearing or increase the load ratio. Contact your Yaskawa representative if you use a Servomotor under these conditions.

Servomotor Model SGM7P-	Moment of Inertia [$\times 10^{-4}$ kg·m ²]				With Low-Backlash Gears			Reference Diagram
	Shaft Output		Flange Output		Allowable Radial Load [N]	Allowable Thrust Load [N]	LF [mm]	
	Motor* + Gear	Gear	Motor* + Gear	Gear				
01A□AH1□	0.0642	0.005	0.0632	0.004	95	431	37	
01A□AHB□	0.119	0.060	0.118	0.059	192	895	53	
01A□AHC□	0.109	0.050	0.109	0.050	233	1087	53	
01A□AH7□	0.509	0.450	0.508	0.449	605	2581	75	
02A□AH1□	0.470	0.207	0.464	0.201	152	707	53	
02A□AHB□	0.456	0.193	0.455	0.192	192	895	53	
02A□AHC□	0.753	0.490	0.751	0.488	528	2254	75	
02A□AH7□	0.713	0.450	0.712	0.449	605	2581	75	
04A□AH1□	0.616	0.207	0.610	0.201	152	707	53	
04A□AHB□	0.979	0.570	0.969	0.560	435	1856	75	
04A□AHC□	0.899	0.490	0.897	0.488	528	2254	75	
04A□AH7□	1.03	0.620	1.01	0.610	951	4992	128	
08A□AH1□	3.20	1.10	3.16	1.06	343	1465	75	
08A□AHB□	2.70	0.600	2.69	0.590	435	1856	75	
08A□AHC□	5.10	3.00	5.08	2.98	830	4359	128	
08A□AH7□	4.90	2.80	4.89	2.79	951	4992	128	
15A□AH1□	7.82	3.80	7.55	3.53	540	2834	128	
15A□AHB□	7.42	3.40	7.36	3.34	684	3590	128	
15A□AHC□	9.82	5.80	9.72	5.70	2042	8840	151	
15A□AH7□	8.82	4.80	8.79	4.77	2338	10120	151	

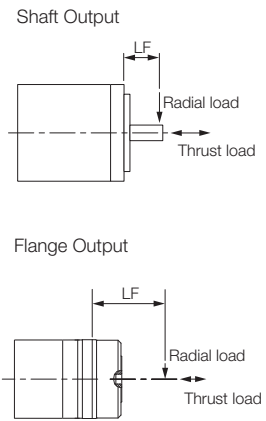

* The moment of inertia for the Servomotor and gear is the value without a holding brake. You can calculate the moment of inertia for a Servomotor with a Gear and Holding Brake with the following formula.
 Motor moment of inertia for a Servomotor with a Holding Brake from 6.2.2 Ratings of Servomotors without Gears on page 6-4 + Moment of inertia for the gear from the above table.



During operation, the gear generates the loss at the gear mechanism and oil seal. The loss depends on the torque and motor speed conditions. The temperature rise depends on the loss and heat dissipation conditions. For the heat dissipation conditions, always refer to the following table and check the gear and motor temperatures with the actual equipment. If the temperature is too high, implement the following measures.

- Decrease the load ratio.
- Change the heat dissipation conditions.
- Use forced-air cooling for the motor with a cooling fan or other means.

Model	Heat Sink Size			
	1/5	1/11	1/21	1/33
SGM7P-01			A	
SGM7P-02			A	
SGM7P-04			B	
SGM7P-08	C		B	
SGM7P-15	C		B	

- A: 250 mm × 250 mm × 6 mm, aluminum plate
- B: 300 mm × 300 mm × 12 mm, aluminum plate
- C: 350 mm × 350 mm × 12 mm, aluminum plate

6.2.5 Servomotor Overload Protection Characteristics

The overload detection level is set for hot start conditions with a Servomotor surrounding air temperature of 40°C.

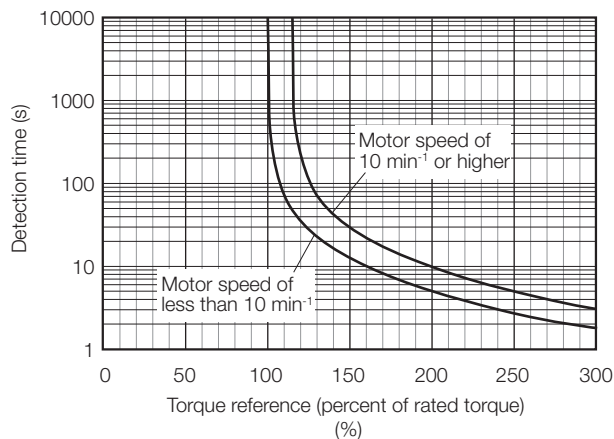

Note: The above overload protection characteristics do not mean that you can perform continuous duty operation with an output of 100% or higher.

Use the Servomotor so that the effective torque remains within the continuous duty zone given in 6.2.3 *Torque-Motor Speed Characteristics* on page 6-5.

6.2.6 Allowable Load Moment of Inertia

The allowable load moments of inertia (motor moment of inertia ratios) for the Servomotors are given in the 6.2.2 *Ratings of Servomotors without Gears* on page 6-4. The values are determined by the regenerative energy processing capacity of the SERVOPACK and are also affected by the drive conditions of the Servomotor. Perform the required Steps for each of the following cases.

Use the SigmaSize+ AC Servo Drive Capacity Selection Program to check the driving conditions. Contact your Yaskawa representative for information on this program.

Exceeding the Allowable Load Moment of Inertia

Use one of the following measures to adjust the load moment of inertia to within the allowable value.

- Reduce the torque limit.
- Reduce the deceleration rate.
- Reduce the maximum motor speed.

If the above steps is not possible, install an external regenerative resistor.

Information

An Overvoltage Alarm (A.400) is likely to occur during deceleration if the load moment of inertia exceeds the allowable load moment of inertia. SERVOPACKs with a built-in regenerative resistor may generate a Regenerative Overload Alarm (A.320). Refer to the following catalog for the regenerative power (W) that can be processed by the SERVOPACKs.

☞ AC Servo Drives Σ -7 Series Product Catalog (Document No.: KAEP S800001 23)

Install an External Regenerative Resistor when the built-in regenerative resistor cannot process all of the regenerative power.

SERVOPACKs without Built-in Regenerative Resistors

The following graph shows the allowable load moment of inertia scaling factor of the motor speed (reference values for deceleration operation at or above the rated torque). Application is possible without an external regenerative resistor within the allowable value. However, an External Regenerative Resistor is required in the shaded areas of the graphs.

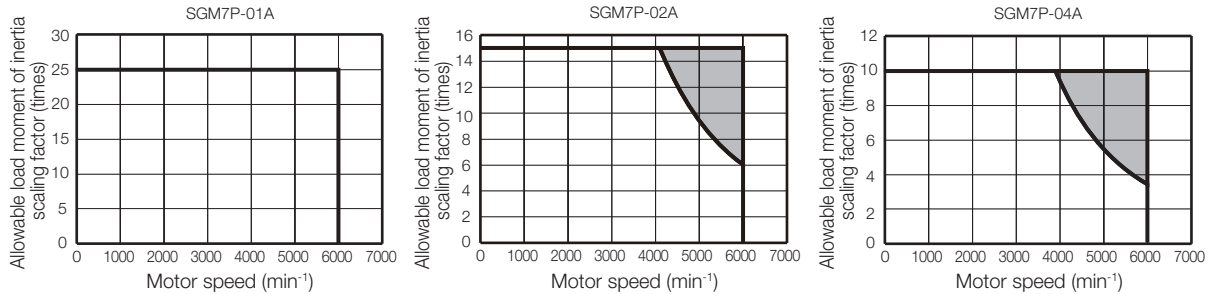

Note: Applicable SERVOPACK models: SGD7S-R70A, -R90A, -1R6A, -2R8A, -R70F, -R90F, -2R1F, and -2R8F

When an External Regenerative Resistor Is Required

Install the External Regenerative Resistor. Refer to the following catalog for the recommended products.

AC Servo Drives Σ -7 Series Product Catalog (Document No.: KAEP S800001 23)

6.2.7 Derating Rates

Servomotor Heat Dissipation Conditions

The Servomotor ratings are the continuous allowable values at a surrounding air temperature of 40°C when a heat sink is installed on the Servomotor. If the Servomotor is mounted on a small device component, the Servomotor temperature may rise considerably because the surface for heat dissipation becomes smaller. Refer to the following graphs for the relation between the heat sink size and derating rate.

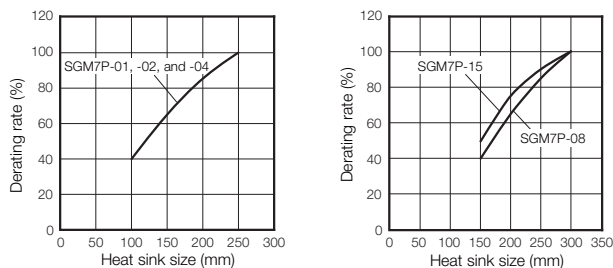

Important

The actual temperature rise depends on the following conditions. Always check the Servomotor temperature with the actual equipment.

- How the heat sink (the Servomotor mounting section) is attached to the installation surface
- Status between heat sink and Servomotor (sealant, reduction gear, etc.)
- What material is used for the Servomotor mounting section
- Servomotor speed

Applications Where the Surrounding Air Temperature Exceeds 40°C

The Servomotor ratings are the continuous allowable values at a surrounding air temperature of 40°C. If you use a Servomotor at a surrounding air temperature that exceeds 40°C (60°C max.), apply a suitable derating rate from the following graphs.

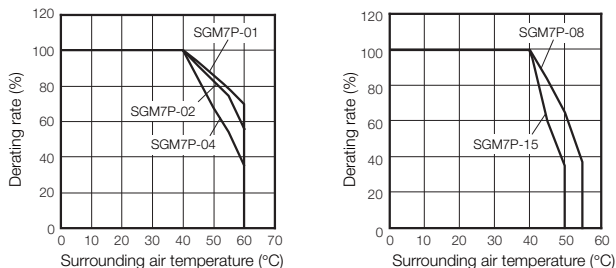

Applications Where the Altitude Exceeds 1,000 m

The Servomotor ratings are the continuous allowable values at an altitude of 1,000 m or less. If you use a Servomotor at an altitude that exceeds 1,000 m (2,000 m max.), the heat dissipation effect of the air is reduced. Apply the appropriate derating rate from the following graphs.

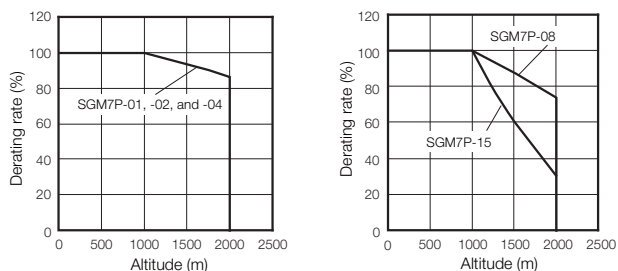

Information

When using Servomotors with derating, change the detection timing of overload warning and overload alarm based on the overload detection level of the motor given in 6.2.5 *Servomotor Overload Protection Characteristics* on page 6-8.

- Note: 1. Use the combination of the SERVOPACK and Servomotor so that the derating conditions are satisfied for both the SERVOPACK and Servomotor.
2. The derating rates are applicable only when the average motor speed is less than or equal to the rated motor speed. If the average motor speed exceeds the rated motor speed, consult with your Yaskawa representative.

6.3 External Dimensions

6.3.1 Servomotors without Gears

SGM7P-01, -02, and -04

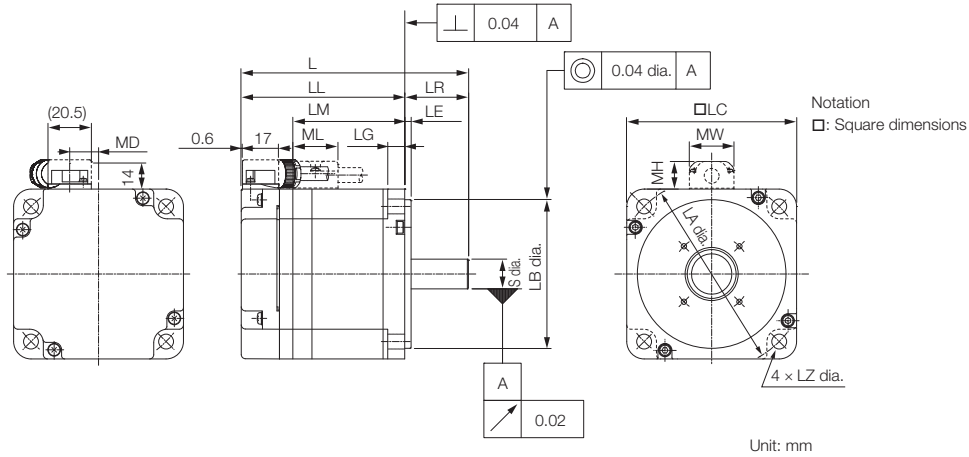

Model SGM7P-	L*	LL*	LM	Flange Dimensions							S	MD	MW	MH	ML	Approx. Mass* [kg]
				LR	LE	LG	LC	LA	LB	LZ						
01A□A2□	85 (115)	60 (90)	36	25	3	6	60	70	50 ⁰ _{-0.025}	5.5	8 ⁰ _{-0.009}	8.5	19	12	20	0.5 (0.9)
02A□A2□	97 (128.5)	67 (98.5)	43	30	3	8	80	90	70 ⁰ _{-0.030}	7	14 ⁰ _{-0.011}	13.6	21	13	21	1.1 (1.9)
04A□A2□	107 (138.5)	77 (108.5)	53	30	3	8	80	90	70 ⁰ _{-0.030}	7	14 ⁰ _{-0.011}	13.6	21	13	21	1.4 (2.2)

* For models that have a batteryless absolute encoder, L and LL are 8 mm greater and the approximate mass is 0.1 kg greater than the given value. Refer to the following section for the values for individual models.

🔗 *Dimensions of Servomotors with Batteryless Absolute Encoders on page 6-17*

Note: 1. The values in parentheses are for Servomotors with Holding Brakes.

2. The values for a straight, without key specification are given. Refer to the information given below for other shaft end specifications and option specifications.

◆ Shaft End Specifications

- Straight with Key and Tap

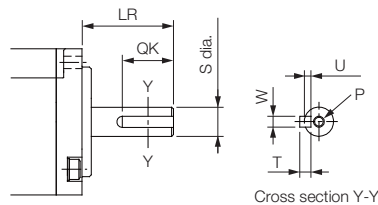

Model SGM7P-	LR	QK	S	W	T	U	P
01A□A6□	25	14	8 ⁰ _{-0.009}	3	3	1.8	M3×6L
02A□A6□	30	14	14 ⁰ _{-0.011}	5	5	3	M5×8L
04A□A6□	30	14	14 ⁰ _{-0.011}	5	5	3	M5×8L

◆ Specifications of Options

- Oil Seal

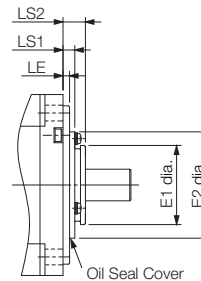

Model SGM7P-	Dimensions with Oil Seal				
	E1	E2	LS1	LS2	LE
01A□A2□	22	38	3.5	7	3
02A□A2□	35	47	5.2	10	3
04A□A2□					

SGM7P-08 and -15

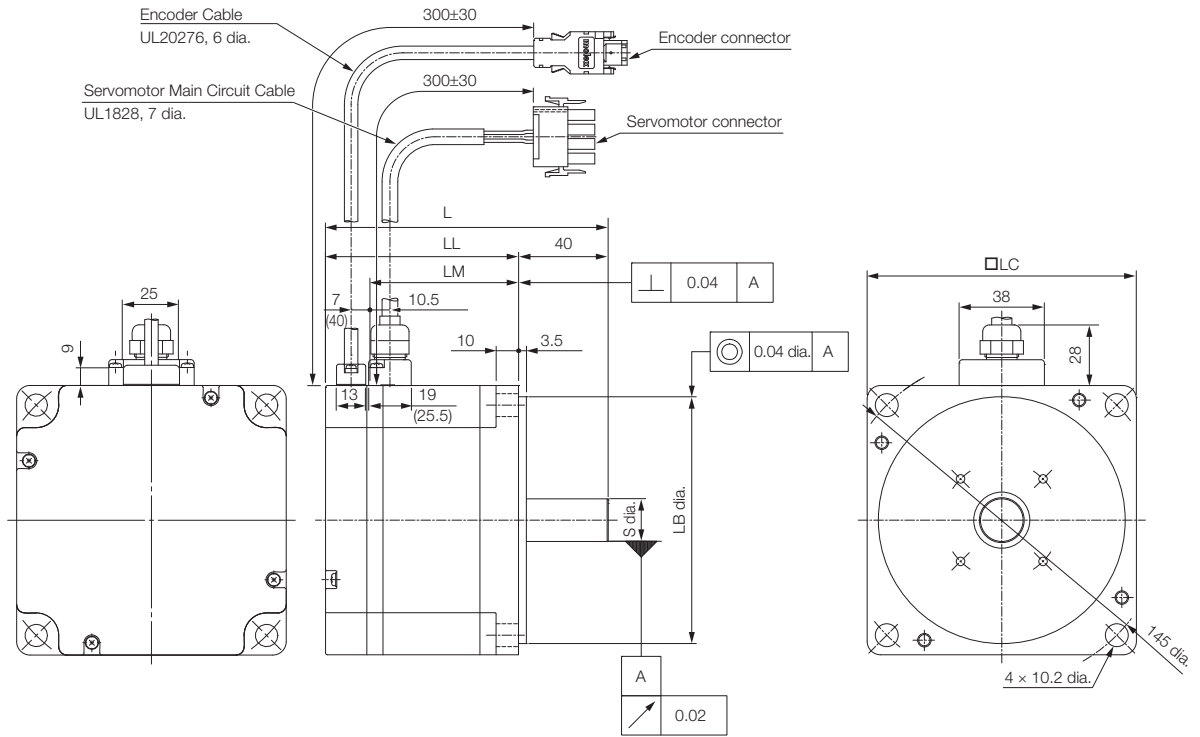

Model SGM7P-	L*	LL*	LM	LB	LC	S	Approx. Mass* [kg]
08A□A2□	126.5 (160)	86.5 (120)	67.6	110 ⁰ _{-0.035}	120	19 ⁰ _{-0.013}	4.2 (5.9)
15A□A2□	154.5 (187.5)	114.5 (147.5)	95.6	110 ⁰ _{-0.035}	120	19 ⁰ _{-0.013}	6.6 (8.2)

* For models that have a batteryless absolute encoder, L and LL are 8 mm greater and the approximate mass is 0.1 kg greater than the given value. Refer to the following section for the values for individual models.

Dimensions of Servomotors with Batteryless Absolute Encoders on page 6-17

Note: 1. The values in parentheses are for Servomotors with Holding Brakes.
 2. The values for a straight, without key specification are given. Refer to the information given below for other shaft end specifications and option specifications.

◆ Shaft End Specifications

- Straight with Key and Tap

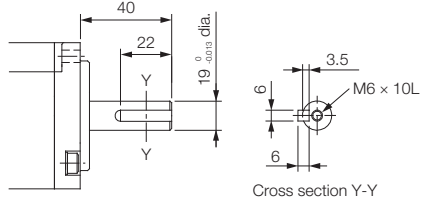

◆ Specifications of Options

- Oil Seal

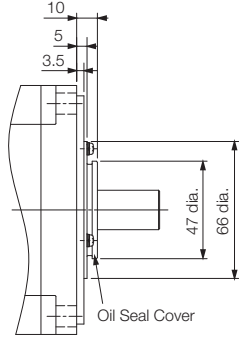

6.3.2 Servomotors with Gears

SGM7P-01, -02, and -04

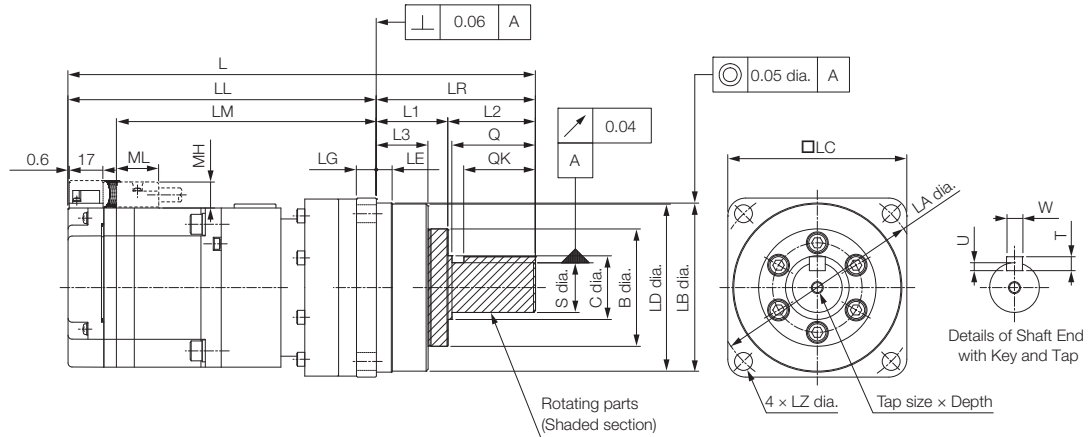

Unit: mm

Model SGM7P-	Gear Ratio	L*	LL*	LM	Flange Dimensions								
					LR	LE	LG	B	LD	LB	LC	LA	LZ
01A□AH1□□	1/5	141.5 (171.5)	99.5 (129.5)	75.5	42	2.2	5	29	39.5	40 ⁰ _{-0.025}	40	46	3.4
01A□AHB□□	1/11	182 (212)	124 (154)	100	58	2.5	8	40	55.5	56 ⁰ _{-0.030}	60	70	5.5
01A□AHC□□	1/21												
01A□AH7□□	1/33	211 (241)	131 (161)	107	80	7.5	10	59	84	85 ⁰ _{-0.035}	90	105	9
02A□AH1□□	1/5	190 (221.5)	132 (163.5)	108	58	2.5	8	40	55.5	56 ⁰ _{-0.030}	60	70	5.5
02A□AHB□□	1/11												
02A□AHC□□	1/21	225 (256.5)	145 (176.5)	121	80	7.5	10	59	84	85 ⁰ _{-0.035}	90	105	9
02A□AH7□□	1/33												
04A□AH1□□	1/5	200 (231.5)	142 (173.5)	118	58	2.5	8	40	55.5	56 ⁰ _{-0.030}	60	70	5.5
04A□AHB□□	1/11	235 (266.5)	155 (186.5)	131	80	7.5	10	59	84	85 ⁰ _{-0.035}	90	105	9
04A□AHC□□	1/21												
04A□AH7□□	1/33	314 (345.5)	181 (212.5)	157	133	12.5	13	84	114	115 ⁰ _{-0.035}	120	135	11

Model SGM7P-	Flange Dimensions			Q	C	S	Tap size × Depth	Key Dimensions				Approx. Mass* [kg]
	L1	L2	L3					QK	U	W	T	
01A□AH1□□	22	20	14.6	–	–	10 ⁰ _{-0.015}	M3 × 6L	15	2.5	4	4	0.9 (1.3)
01A□AHB□□	28	30	20	28	20	16 ⁰ _{-0.018}	M4 × 8L	25	3	5	5	1.6 (2.0)
01A□AHC□□												
01A□AH7□□	36	44	26	42	32	25 ⁰ _{-0.021}	M6 × 12L	36	4	8	7	3.4 (3.8)
02A□AH1□□	28	30	20	28	20	16 ⁰ _{-0.018}	M4 × 8L	25	3	5	5	2.3 (2.9) 2.4 (3.0)
02A□AHB□□												
02A□AHC□□	36	44	26	42	32	25 ⁰ _{-0.021}	M6 × 12L	36	4	8	7	4.2 (5.0)
02A□AH7□□												
04A□AH1□□	28	30	20	28	20	16 ⁰ _{-0.018}	M4 × 8L	25	3	5	5	2.6 (3.2)
04A□AHB□□	36	44	26	42	32	25 ⁰ _{-0.021}	M6 × 12L	36	4	8	7	4.5 (5.3)
04A□AHC□□												
04A□AH7□□	48	85	33	82	44	40 ⁰ _{-0.025}	M10 × 20L	70	5	12	8	9.2 (10.0)

* For models that have a batteryless absolute encoder, L and LL are 8 mm greater and the approximate mass is 0.1 kg greater than the given value. Refer to the following section for the values for individual models.

Dimensions of Servomotors with Batteryless Absolute Encoders on page 6-17

6.3 External Dimensions

6.3.2 Servomotors with Gears

- Note: 1. The values in parentheses are for Servomotors with Holding Brakes.
 2. Gear dimensions are different from those of the Σ, Σ-II, and Σ-III Series.
 3. The values for the shaft end are for a straight shaft with key and tap. If a key and tap are not necessary, specify shaft end code 2 for the 8th digit.

◆ Flange Output Face

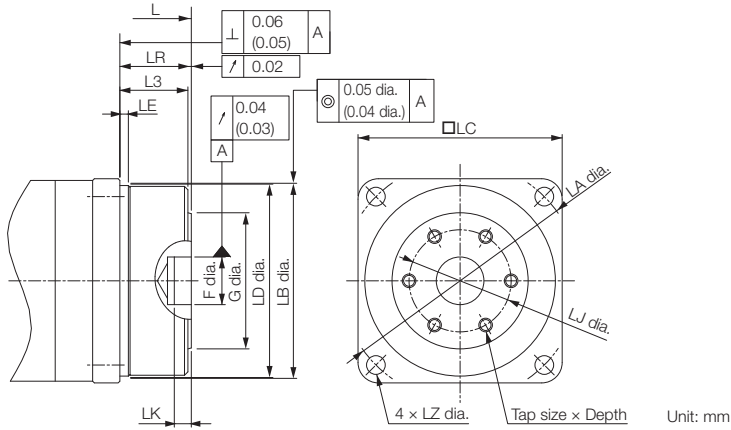

Note: The geometric tolerance in parentheses is the value for LC = 40.

Model SGM7P-	Gear Ratio	L*	LR	LJ	F	G	LK	No. of Taps × Tap Size × Depth	Approx. Mass* [kg]
01A□AH10□	1/5	114.5 (144.5)	15	18	5 ^{+0.012} ₀	24	3	3 × M4 × 6L	0.8 (1.2)
01A□AHB0□	1/11	145 (175)	21	30	14 ^{+0.018} ₀	40	5	6 × M4 × 7L	1.5 (1.9)
01A□AHC0□	1/21								
01A□AH70□	1/33	158 (188)	27	45	24 ^{+0.021} ₀	59	5	6 × M6 × 10L	3.0 (3.4)
02A□AH10□	1/5	153 (184.5)	21	30	14 ^{+0.018} ₀	40	5	6 × M4 × 7L	2.2 (2.8)
02A□AHB0□	1/11								2.3 (2.9)
02A□AHC0□	1/21	172 (203.5)	27	45	24 ^{+0.021} ₀	59	5	6 × M6 × 10L	3.8 (4.6)
02A□AH70□	1/33								
04A□AH10□	1/5	163 (194.5)	21	30	14 ^{+0.018} ₀	40	5	6 × M4 × 7L	2.5 (3.1)
04A□AHB0□	1/11	182 (213.5)	27	45	24 ^{+0.021} ₀	59	5	6 × M6 × 10L	4.1 (4.9)
04A□AHC0□	1/21								
04A□AH70□	1/33	216 (247.5)	35	60	32 ^{+0.025} ₀	84	5	6 × M8 × 12L	7.8 (8.6)

* For models that have a batteryless absolute encoder, L is 8 mm greater and the approximate mass is 0.1 kg greater than the given value. Refer to the following section for the values for individual models.

📖 *Dimensions of Servomotors with Batteryless Absolute Encoders on page 6-17*

- Note: 1. The values in parentheses are for Servomotors with Holding Brakes.
 2. Dimensions not found in the above table are the same as those in the table on the previous page.

Important For a Servomotor with a flange output that has square gear flange dimensions (□LC) of 40 mm, we recommend that you design the Servomotor with the dimensions shown in the following figure in order to secure a gap between the gear oil seal and the connecting parts on the load side.

SGM7P-08 and -15

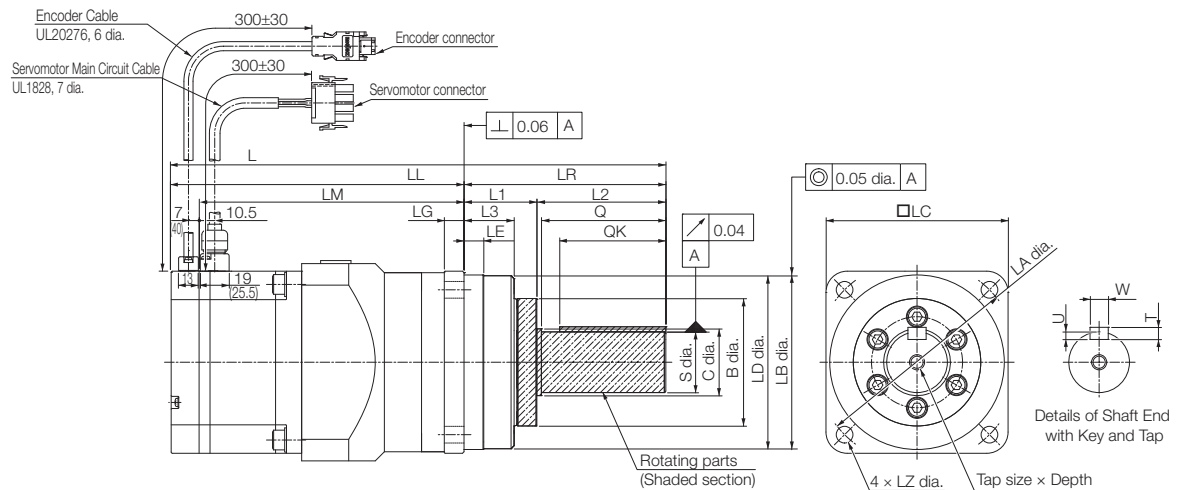

Unit: mm

Model SGM7P-	Gear Ratio	L*	LL*	LM	Flange Dimensions								
					LR	LE	LG	B	LD	LB	LC	LA	LZ
08A□AH1□□	1/5	253.5	173.5	154.6	80	7.5	10	59	84	85 ⁰ _{-0.035}	90	105	9
08A□AHB□□	1/11	(287)	(207)										
08A□AHC□□	1/21	326.5	193.5										
08A□AH7□□	1/33	(360)	(227)	174.6	133	12.5	13	84	114	115 ⁰ _{-0.035}	120	135	11
15A□AH1□□	1/5	354.5	221.5	202.6	133	12.5	13	84	114	115 ⁰ _{-0.035}	120	135	11
15A□AHB□□	1/11	(387.5)	(254.5)										
15A□AHC□□	1/21	393.5	237.5										
15A□AH7□□	1/33	(426.5)	(270.5)	218.6	156	12	16	122	163	165 ⁰ _{-0.063}	170	190	14

Model SGM7P-	Flange Dimensions			Q	C	S	Tap size × Depth	Key Dimensions				Approx. Mass* [kg]
	L1	L2	L3					QK	U	W	T	
08A□AH1□□	36	44	26	42	32	25 ⁰ _{-0.021}	M6 × 12L	36	4	8	7	6.9 (8.6)
08A□AHB□□												7.1 (8.8)
08A□AHC□□	48	85	33	82	44	40 ⁰ _{-0.025}	M10 × 20L	70	5	12	8	12 (13.7)
08A□AH7□□												
15A□AH1□□	48	85	33	82	44	40 ⁰ _{-0.025}	M10 × 20L	70	5	12	8	13.9 (15.5)
15A□AHB□□												14.4 (16.0)
15A□AHC□□	70	86	51	82	56	50 ⁰ _{-0.025}	M10 × 20L	70	5.5	14	9	25.7 (27.3)
15A□AH7□□												

* For models that have a batteryless absolute encoder, L and LL are 8 mm greater and the approximate mass is 0.1 kg greater than the given value. Refer to the following section for the values for individual models.

Dimensions of Servomotors with Batteryless Absolute Encoders on page 6-17

Note: 1. The values in parentheses are for Servomotors with Holding Brakes.

2. Gear dimensions are different from those of the Σ, Σ-II, and Σ-III Series.

3. The values for the shaft end are for a straight shaft with key and tap. If a key and tap are not necessary, specify shaft end code 2 for the 8th digit.

◆ Flange Output Face

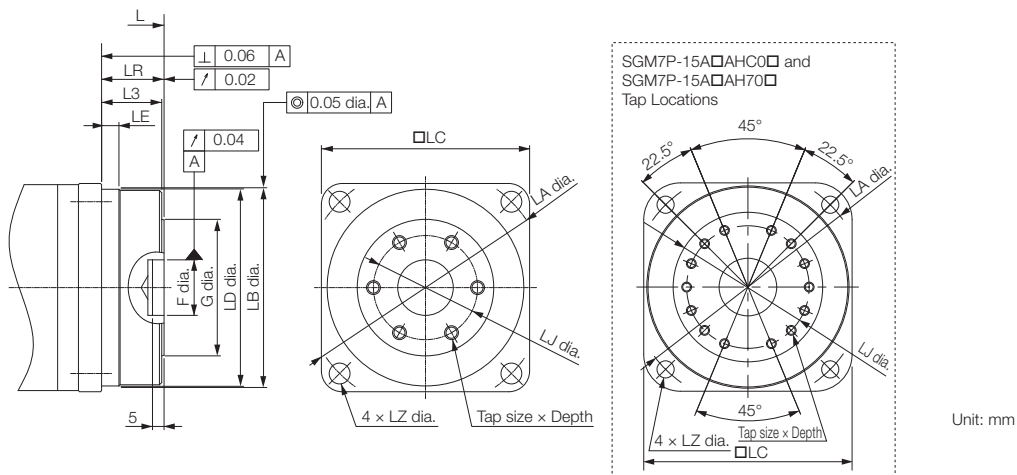

Model SGM7P-	Gear Ratio	L*	LR	LJ	F	G	LK	No. of Taps x Tap Size x Depth	Approx. Mass* [kg]
08A□AH10□	1/5	200.5 (234)	27	45	24 ^{+0.021} ₀	59	5	6 x M6 x 10L	6.5 (8.2)
08A□AHB0□	1/11								6.7 (8.4)
08A□AHC0□	1/21	228.5 (262)	35	60	32 ^{+0.025} ₀	84	5	6 x M8 x 12L	10.6 (12.3)
08A□AH70□	1/33								
15A□AH10□	1/5	256.5 (289.5)	35	60	32 ^{+0.025} ₀	84	5	6 x M8 x 12L	12.5 (14.1)
15A□AHB0□	1/11								13 (14.6)
15A□AHC0□	1/21	290.5 (323.5)	53	100	47 ^{+0.025} ₀	122	7	14 x M8 x 12L	22.7 (24.3)
15A□AH70□	1/33								

* For models that have a batteryless absolute encoder, L is 8 mm greater and the approximate mass is 0.1 kg greater than the given value. Refer to the following section for the values for individual models.

Dimensions of Servomotors with Batteryless Absolute Encoders on page 6-17

Note: 1. The values in parentheses are for Servomotors with Holding Brakes.

2. Dimensions not found in the above table are the same as those in the table on the previous page.

Dimensions of Servomotors with Batteryless Absolute Encoders

◆ Servomotors without Gears

Model SGM7P-	L	LL	Approx. Mass [kg]
01A6A2□	93 (123)	68 (98)	0.5 (0.9)
02A6A2□	105 (136.5)	75 (106.5)	1.2 (2.0)
04A6A2□	115 (146.5)	85 (116.5)	1.5 (2.3)
08A6A2□	134.5 (168)	94.5 (128)	4.3 (6.0)
15A6A2□	162.5 (195.5)	122.5 (155.5)	6.7 (8.3)

Note: The values in parentheses are for Servomotors with Holding Brakes.

◆ Servomotors with Gears

• Shaft End Specification: Straight

Model SGM7P-	L	LL	Approx. Mass [kg]
01A6AH1□□	149.5 (179.5)	107.5 (179.5)	0.9 (1.3)
01A6AHB□□	190 (220)	132 (162)	1.6 (2.0)
01A6AHC□□			
01A6AH7□□	219 (249)	139 (169)	3.4 (3.8)
02A6AH1□□	198 (229.5)	140 (171.5)	2.4 (3.0)
02A6AHB□□			2.5 (3.1)
02A6AHC□□	233 (264.5)	153 (184.5)	4.3 (5.1)
02A6AH7□□			
04A6AH1□□	208 (239.5)	150 (181.5)	2.7 (3.3)
04A6AHB□□	243 (274.5)	163 (194.5)	4.6 (5.4)
04A6AHC□□			
04A6AH7□□	322 (354.5)	191 (220.5)	9.3 (10.1)
08A6AH1□□	261.5 (295)	181.5 (215)	7.0 (8.7)
08A6AHB□□			7.2 (8.9)
08A6AHC□□	334.5 (368)	201.5 (235)	12.1 (13.8)
08A6AH7□□			
15A6AH1□□	362.5 (395.5)	229.5 (262.5)	14.0 (15.6)
15A6AHB□□			14.5 (16.1)
15A6AHC□□	401.5 (434.5)	245.5 (278.5)	25.8 (27.4)
15A6AH7□□			

• Shaft End Specification: Flange Output

Model SGM7P-	L	Approx. Mass [kg]
01A6AH10□	122.5 (152.5)	0.8 (1.2)
01A6AHB0□	153 (183)	1.5 (1.9)
01A6AHC0□		
01A6AH70□	166 (196)	3.0 (3.4)
02A6AH10□	161 (192.5)	2.3 (2.9)
02A6AHB0□		2.4 (3.0)
02A6AHC0□	180 (211.5)	3.9 (4.7)
02A6AH70□		
04A6AH10□	171 (202.5)	2.6 (3.2)
04A6AHB0□	190 (221.5)	4.2 (5.0)
04A6AHC0□		
04A6AH70□	224 (255.5)	7.9 (8.7)
08A6AH10□	208.5 (242)	6.6 (8.3)
08A6AHB0□		6.8 (8.5)
08A6AHC0□	236.5 (270)	10.7 (12.4)
08A6AH70□		
15A6AH10□	264.5 (297.5)	12.6 (14.2)
15A6AHB0□		13.1 (14.7)
15A6AHC0□	298.5 (331.5)	22.8 (24.4)
15A6AH70□		

Note: The values in parentheses are for Servomotors with Holding Brakes.

Specifications, Ratings, and External Dimensions of SGM7G Servomotors

7

This chapter describes how to interpret the model numbers of SGM7G Servomotors and gives their specifications, ratings, and external dimensions.

7.1 Model Designations 7-2

7.2 Specifications and Ratings 7-3

- 7.2.1 Specifications 7-3
- 7.2.2 Servomotor Ratings of the SGM7G-03 to -20 . . . 7-4
- 7.2.3 Torque-Motor Speed Characteristics of
the SGM7G-03 to -20 7-5
- 7.2.4 Servomotor Ratings of the SGM7G-30 to -1E . . . 7-6
- 7.2.5 Torque-Motor Speed Characteristics of
the SGM7G-30 to -1E 7-7
- 7.2.6 Servomotor Overload Protection
Characteristics 7-8
- 7.2.7 Allowable Load Moment of Inertia 7-9
- 7.2.8 Derating Rates 7-9

7.3 External Dimensions 7-11

- 7.3.1 Servomotors without Holding Brakes 7-11
- 7.3.2 Servomotors with Holding Brakes 7-14

7.1 Model Designations

SGM7G - 03 A 7 A 2 1

1st+2nd digits 3rd digit 4th digit 5th digit 6th digit 7th digit

Σ-7 Series
Servomotors:
SGM7G

1st+2nd digits Rated Output

Code	Specification
03	300 W
05	450 W
09	850 W
13	1.3 kW
20	1.8 kW
30	2.9 kW*
44	4.4 kW
55	5.5 kW
75	7.5 kW
1A	11 kW
1E	15 kW

3rd digit Power Supply Voltage

Code	Specification
A	200 VAC

4th digit Serial Encoder

Code	Specification
6	24-bit batteryless absolute
7	24-bit absolute
F	24-bit incremental

5th digit Design Revision Order

A

6th digit Shaft End

Code	Specification
2	Straight without key
6	Straight with key and tap

7th digit Options

Code	Specification
1	Without options
C	With holding brake (24 VDC)
E	With oil seal and holding brake (24 VDC)
S	With oil seal

* The rated output is 2.4 kW if you combine the SGM7G-30A with the SGD7S-200A.

7.2 Specifications and Ratings

7.2.1 Specifications

Voltage		200 V										
Model SGM7G-		03A	05A	09A	13A	20A	30A	44A	55A	75A	1AA	1EA
Time Rating		Continuous										
Thermal Class		UL: F, CE: F										
Insulation Resistance		500 VDC, 10 M Ω min.										
Withstand Voltage		1,500 VAC for 1 minute										
Excitation		Permanent magnet										
Mounting		Flange-mounted										
Drive Method		Direct drive										
Rotation Direction		Counterclockwise (CCW) for forward reference when viewed from the load side										
Vibration Class* ¹		V15										
Environmental Conditions	Surrounding Air Temperature	0°C to 40°C (60°C max.)* ³										
	Surrounding Air Humidity	20% to 80% relative humidity (with no condensation)										
	Installation Site	<ul style="list-style-type: none"> • Must be indoors and free of corrosive and explosive gases. • Must be well-ventilated and free of dust and moisture. • Must facilitate inspection and cleaning. • Must have an altitude of 1,000 m or less. (With derating, usage is possible between 1,000 m and 2,000 m.)*³ • Must be free of strong magnetic fields. 										
	Storage Environment	Store the Servomotor in the following environment if you store it with the power cable disconnected. Storage temperature: -20°C to 60°C (with no freezing) Storage humidity: 20% to 80% relative humidity (with no condensation)										
Shock Resistance* ²	Impact Acceleration Rate at Flange	490 m/s ²										
	Number of Impacts	2 times										
Vibration Resistance* ²	Vibration Acceleration Rate at Flange	49 m/s ² (24.5 m/s ² front to back)						24.5 m/s ²				
Applicable SERVOPACKs	SGD7S-	3R8A	7R6A	120A	180A	330A	470A	550A	590A	780A		
	SGD7W- SGD7C-	5R5A* ⁴ 7R6A* ⁴	7R6A	-								

*1. A vibration class of V15 indicates a vibration amplitude of 15 μ m maximum on the Servomotor without a load at the rated motor speed.

*2. The given values are for when the Servomotor shaft is mounted horizontally and shock or vibration is applied in the directions shown in the following figures.
The strength of the vibration that the Servomotor can withstand depends on the application. Always check the vibration acceleration rate that is applied to the Servomotor with the actual equipment.

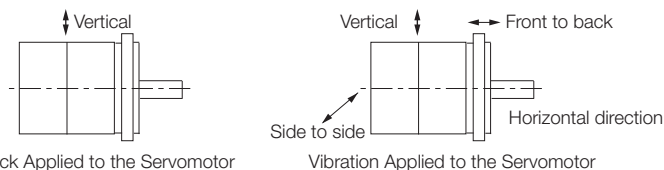

*3. Refer to the following section for the derating rates.

 **7.2.8 Derating Rates on page 7-9**

*4. If you use the Servomotor together with a Σ -7W or Σ -7C SERVOPACK, the control gain may not increase as much as with a Σ -7S SERVOPACK and other performances may be lower than those achieved with a Σ -7S SERVOPACK.

7.2.2 Servomotor Ratings of the SGM7G-03 to -20

Voltage		200 V				
Model SGM7G-		03A	05A	09A	13A	20A
Rated Output* ¹	kW	0.3	0.45	0.85	1.3	1.8
Rated Torque* ^{1, *2}	N·m	1.96	2.86	5.39	8.34	11.5
Instantaneous Maximum Torque* ¹	N·m	5.88	8.92	14.2	23.3	28.7
Rated Current* ¹	Arms	2.8	3.8	6.9	10.7	16.7
Instantaneous Maximum Current* ¹	Arms	8.0	11	17	28	42
Rated Motor Speed* ¹	min ⁻¹	1500				
Maximum Motor Speed* ¹	min ⁻¹	3000				
Torque Constant	N·m/Arms	0.776	0.854	0.859	0.891	0.748
Motor Moment of Inertia	×10 ⁻⁴ kg·m ²	2.48 (2.73)	3.33 (3.58)	13.9 (16.0)	19.9 (22.0)	26.0 (28.1)
Rated Power Rate* ¹	kW/s	15.5 (14.1)	24.6 (22.8)	20.9 (18.2)	35.0 (31.6)	50.9 (47.1)
Rated Angular Acceleration Rate* ¹	rad/s ²	7900 (7180)	8590 (7990)	3880 (3370)	4190 (3790)	4420 (4090)
Heat Sink Size* ³	mm	250 × 250 × 6 (aluminum)		400 × 400 × 20 (steel)		
Protective Structure* ⁴		Totally enclosed, self-cooled, IP67				
Holding Brake Specifications* ⁵	Rated Voltage	V	24 VDC ^{+10%} ₀			
	Capacity	W	10			
	Holding Torque	N·m	4.5	12.7	19.6	
	Coil Resistance	Ω (at 20°C)	56	59		
	Rated Current	A (at 20°C)	0.43	0.41		
	Time Required to Release Brake	ms	100			
	Time Required to Brake	ms	80			
Allowable Load Moment of Inertia (Motor Moment of Inertia Ratio)* ⁶		15 times	15 times	5 times		
With External Regenerative Resistor and External Dynamic Brake Resistor* ⁷		15 times	15 times	10 times		
Allowable Shaft Loads* ⁸	LF	mm	40		58	
	Allowable Radial Load	N	490		686	980
	Allowable Thrust Load	N	98		343	392

Note: The values in parentheses are for Servomotors with Holding Brakes.

*1. These values are for operation in combination with a SERVOPACK when the temperature of the armature winding is 20°C. These are typical values.

*2. The rated torques are the continuous allowable torque values with an aluminum or steel heat sink of the dimensions given in the table.

*3. Refer to the following section for the relation between the heat sinks and derating rate.

 Servomotor Heat Dissipation Conditions on page 7-9

*4. This does not apply to the shaft opening. Protective structure specifications apply only when the special cable is used.

*5. Observe the following precautions if you use a Servomotor with a Holding Brake.

- The holding brake cannot be used to stop the Servomotor.
- The time required to release the brake and the time required to brake depend on which discharge circuit is used. Confirm that the operation delay time is appropriate for the actual equipment.
- The 24-VDC power supply is not provided by Yaskawa.

*6. The motor moment of inertia scaling factor is the value for a standard Servomotor without a Holding Brake.

*7. To externally connect a dynamic brake resistor, select hardware option specification 020 for the SERVOPACK.

*8. Design the mechanical system so that the thrust and radial loads applied to the Servomotor shaft end during operation do not exceed the values given in the table.

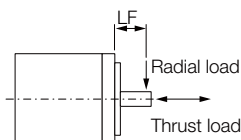

7.2.3 Torque-Motor Speed Characteristics of the SGM7G-03 to -20

A : Continuous duty zone — (solid lines): With three-phase 200-V or single-phase 230-V input
B : Intermittent duty zone - - - (dotted lines): With single-phase 200-V input

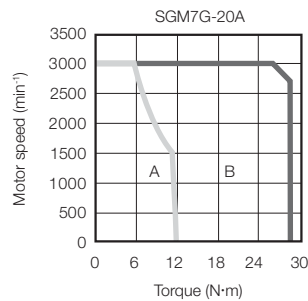
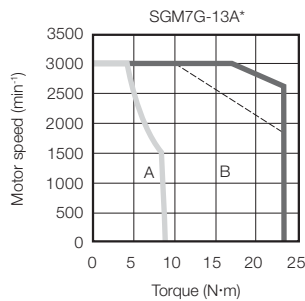
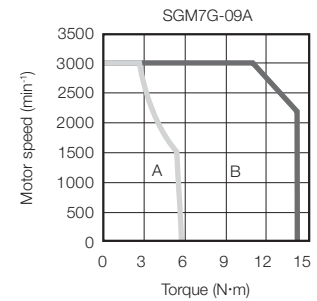
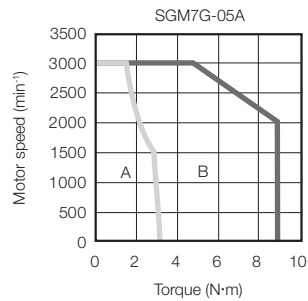
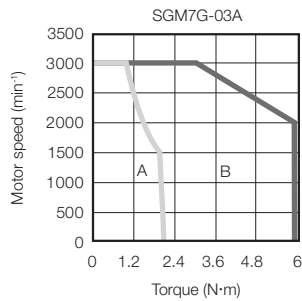

* A single-phase power input can be used in combination with the SGD7S-120A□□A008.

- Note: 1. These values (typical values) are for operation in combination with a SERVOPACK when the temperature of the armature winding is 20°C.
2. The characteristics in the intermittent duty zone depend on the power supply voltage.
3. If the effective torque is within the allowable range for the rated torque, the Servomotor can be used within the intermittent duty zone.
4. If you use a Servomotor Main Circuit Cable that exceeds 20 m, the intermittent duty zone in the torque-motor speed characteristics will become smaller because the voltage drop increases.

7.2.4 Servomotor Ratings of the SGM7G-30 to -1E

Voltage		200 V						
Model SGM7G-		30A	30A* ⁹	44A	55A	75A	1AA	1EA
Rated Output* ¹	kW	2.9	2.4	4.4	5.5	7.5	11	15
Rated Torque* ^{1, 2}	N·m	18.6	15.1	28.4	35.0	48.0	70.0	95.4
Instantaneous Maximum Torque* ¹	N·m	54.0	45.1	71.6	102	119	175	224
Rated Current* ¹	Arms	23.8	19.6	32.8	37.2	54.7	58.6	78.0
Instantaneous Maximum Current* ¹	Arms	70	56	84	110	130	140	170
Rated Motor Speed* ¹	min ⁻¹	1500	1500	1500	1500	1500	1500	1500
Maximum Motor Speed* ¹	min ⁻¹	3000	3000	3000	3000	3000	2000	2000
Torque Constant	N·m/Arms	0.848	0.848	0.934	1.00	0.957	1.38	1.44
Motor Moment of Inertia	×10 ⁻⁴ kg·m ²	46.0 (53.9)	46.0 (53.9)	67.5 (75.4)	89.0 (96.9)	125 (133)	242 (261)	303 (341)
Rated Power Rate* ¹	kW/s	75.2 (64.2)	49.5 (42.2)	119 (107)	138 (126)	184 (173)	202 (188)	300 (267)
Rated Angular Acceleration Rate* ¹	rad/s ²	4040 (3450)	3280 (2800)	4210 (3770)	3930 (3610)	3840 (3610)	2890 (2680)	3150 (2800)
Heat Sink Size* ³	mm	550 × 550 × 30 (steel)					650 × 650 × 35 (steel)	
Protective Structure* ⁴		Totally enclosed, self-cooled, IP67						
Holding Brake Specifications* ⁵	Rated Voltage	V	24 VDC ^{+10%} ₀					
	Capacity	W	18.5		25	32	35	
	Holding Torque	N·m	43.1		72.6	84.3	114.6	
	Coil Resistance	Ω (at 20°C)	31		23	18	17	
	Rated Current	A (at 20°C)	0.77		1.05	1.33	1.46	
	Time Required to Release Brake	ms	170					250
	Time Required to Brake	ms	100			80		
Allowable Load Moment of Inertia (Motor Moment of Inertia Ratio)* ⁶		5 times	3 times	5 times				
With External Regenerative Resistor and External Dynamic Brake Resistor* ⁷		10 times	7 times	10 times				
Allowable Shaft Loads* ⁸	LF	mm	79		113	116		
	Allowable Radial Load	N	1470		1764		4998	
	Allowable Thrust Load	N	490		588		2156	

Note: The values in parentheses are for Servomotors with Holding Brakes.

- *1. These values are for operation in combination with a SERVOPACK when the temperature of the armature winding is 20°C. These are typical values.
- *2. The rated torques are the continuous allowable torque values with an aluminum or steel heat sink of the dimensions given in the table.
- *3. Refer to the following section for the relation between the heat sinks and derating rate.
 **Servomotor Heat Dissipation Conditions** on page 7-9
- *4. This does not apply to the shaft opening. Protective structure specifications apply only when the special cable is used.
- *5. Observe the following precautions if you use a Servomotor with a Holding Brake.
 - The holding brake cannot be used to stop the Servomotor.
 - The time required to release the brake and the time required to brake depend on which discharge circuit is used. Confirm that the operation delay time is appropriate for the actual equipment.
 - The 24-VDC power supply is not provided by Yaskawa.
- *6. The motor moment of inertia scaling factor is the value for a standard Servomotor without a Holding Brake.
- *7. To externally connect a dynamic brake resistor, select hardware option specification 020 for the SERVOPACK.

7.2.5 Torque-Motor Speed Characteristics of the SGM7G-30 to -1E

*8. Design the mechanical system so that the thrust and radial loads applied to the Servomotor shaft end during operation do not exceed the values given in the table.

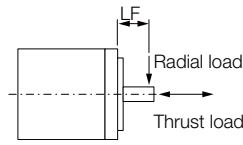

*9. This is the value if you combine the SGM7G-30A with the SGD7S-200A.

7.2.5 Torque-Motor Speed Characteristics of the SGM7G-30 to -1E

A : Continuous duty zone (solid lines): With three-phase 200-V input
B : Intermittent duty zone (dotted lines): When combined with the SGD7S-200A

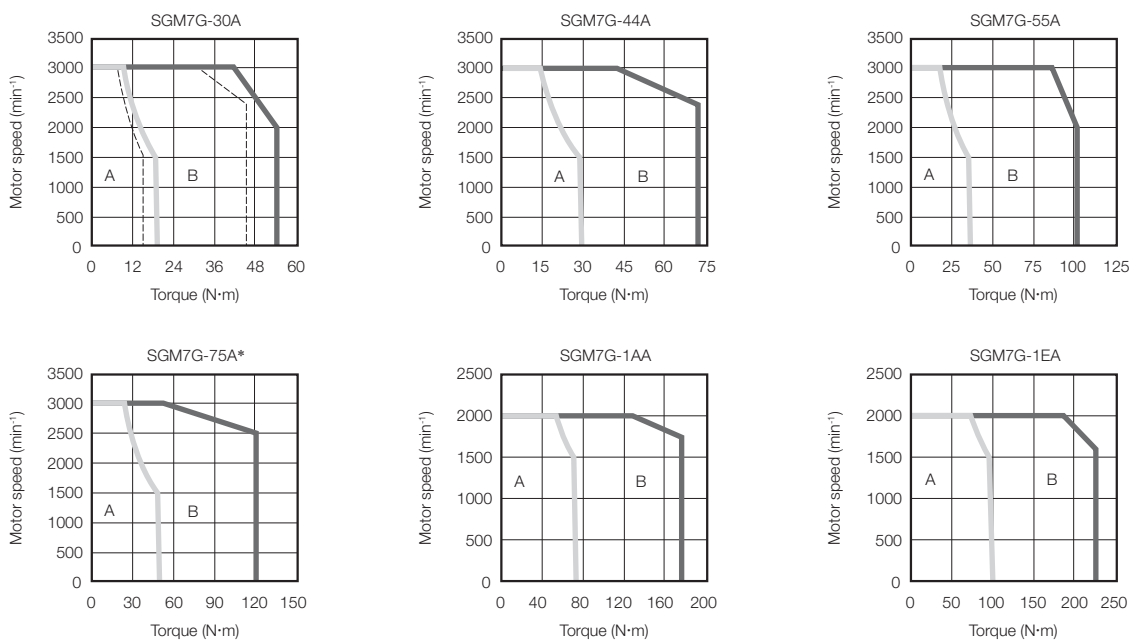

* If you operate the SGM7G-75A Servomotor (with holding brake) continuously at the maximum motor speed of 3,000 min⁻¹, use an output torque of 14.4 N·m (30% of rated torque) or less.

Note: 1. These values (typical values) are for operation in combination with a SERVOPACK when the temperature of the armature winding is 20°C.

2. The characteristics in the intermittent duty zone depend on the power supply voltage.
3. If the effective torque is within the allowable range for the rated torque, the Servomotor can be used within the intermittent duty zone.
4. If you use a Servomotor Main Circuit Cable that exceeds 20 m, the intermittent duty zone in the torque-motor speed characteristics will become smaller because the voltage drop increases.

7.2.6 Servomotor Overload Protection Characteristics

The overload detection level is set for hot start conditions with a Servomotor surrounding air temperature of 40°C.

SGM7G-03 and -05

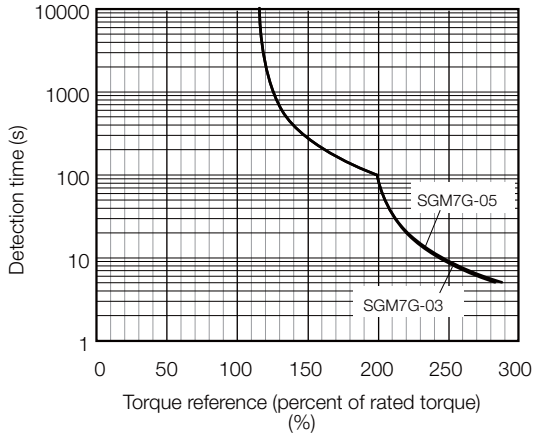

SGM7G-09, -13, and -20

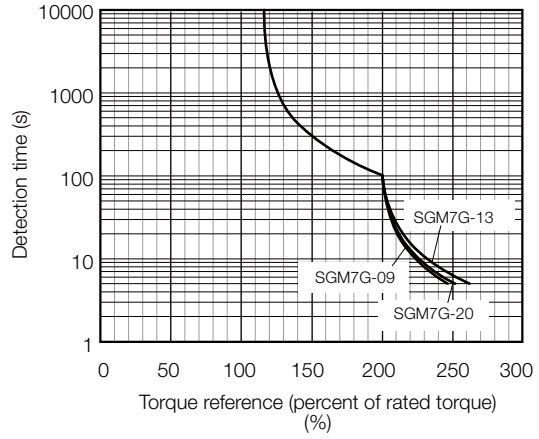

SGM7G-30, -44, -55, and -75

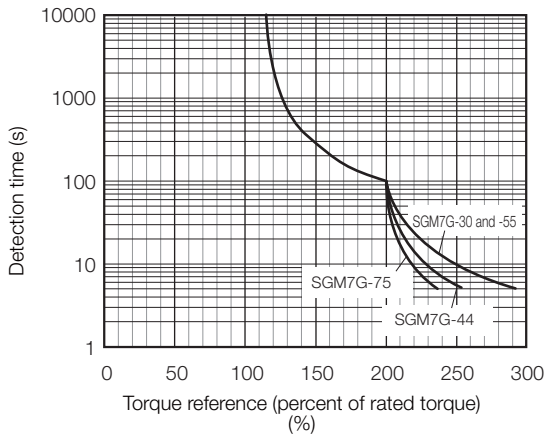

SGM7G-1A and -1E

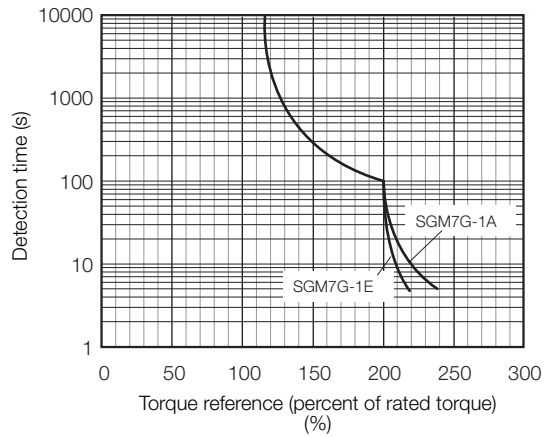

Note: The above overload protection characteristics do not mean that you can perform continuous duty operation with an output of 100% or higher. Use the Servomotor so that the effective torque remains within the continuous duty zone given in 7.2.3 Torque-Motor Speed Characteristics of the SGM7G-03 to -20 on page 7-5 or 7.2.5 Torque-Motor Speed Characteristics of the SGM7G-30 to -1E on page 7-7.

7.2.7 Allowable Load Moment of Inertia

The allowable load moments of inertia (motor moment of inertia ratios) for the Servomotors are given in the Servomotor Ratings on pages 7-4 and 7-6. The values are determined by the regenerative energy processing capacity of the SERVOPACK and are also affected by the drive conditions of the Servomotor. Perform the required Steps for each of the following cases.

Use the SigmaSize+ AC Servo Drive Capacity Selection Program to check the driving conditions. Contact your Yaskawa representative for information on this program.

Exceeding the Allowable Load Moment of Inertia

Use one of the following measures to adjust the load moment of inertia to within the allowable value.

- Reduce the torque limit.
- Reduce the deceleration rate.
- Reduce the maximum motor speed.

If the above steps is not possible, install an external regenerative resistor.

Information

An Overvoltage Alarm (A.400) is likely to occur during deceleration if the load moment of inertia exceeds the allowable load moment of inertia. SERVOPACKs with a built-in regenerative resistor may generate a Regenerative Overload Alarm (A.320). Refer to the following catalog for the regenerative power (W) that can be processed by the SERVOPACKs.

📖 AC Servo Drives Σ -7 Series Product Catalog (Document No.: KAEP S800001 23)

Install an External Regenerative Resistor when the built-in regenerative resistor cannot process all of the regenerative power.

When an External Regenerative Resistor Is Required

Install the External Regenerative Resistor. Refer to the following catalog for the recommended products.

📖 AC Servo Drives Σ -7 Series Product Catalog (Document No.: KAEP S800001 23)

7.2.8 Derating Rates

Servomotor Heat Dissipation Conditions

The Servomotor ratings are the continuous allowable values when a heat sink is installed on the Servomotor. If the Servomotor is mounted on a small device component, the Servomotor temperature may rise considerably because the surface for heat dissipation becomes smaller. Refer to the following graphs for the relation between the heat sink size and derating rate.

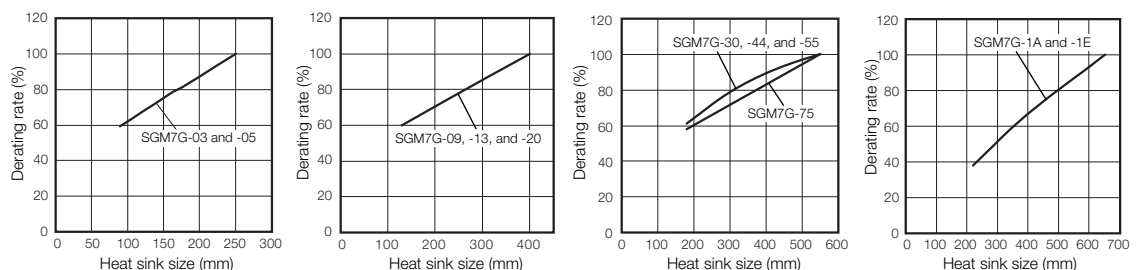

The actual temperature rise depends on the following conditions. Always check the Servomotor temperature with the actual equipment.

- How the heat sink (the Servomotor mounting section) is attached to the installation surface
- Status between heat sink and Servomotor (sealant, reduction gear, etc.)
- What material is used for the Servomotor mounting section
- Servomotor speed

Servomotor Derating Rates for Surrounding Air Temperatures

Apply a suitable derating rate from the following graphs according to the surrounding air temperature of the Servomotor (60°C max.).

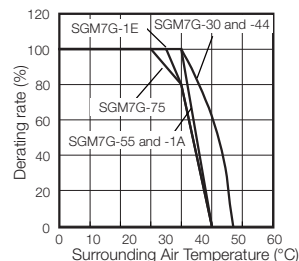
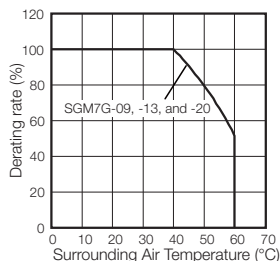
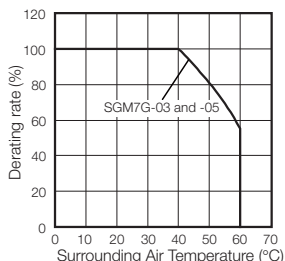

Applications Where the Altitude Exceeds 1,000 m

The Servomotor ratings are the continuous allowable values at an altitude of 1,000 m or less. If you use a Servomotor at an altitude that exceeds 1,000 m (2,000 m max.), the heat dissipation effect of the air is reduced. Apply the appropriate derating rate from the following graphs.

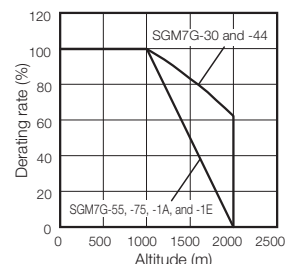
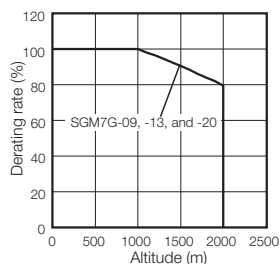
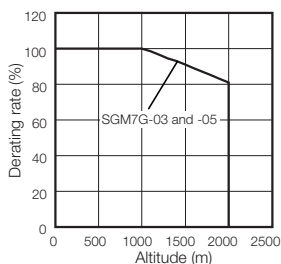

Information

When using Servomotors with derating, change the detection timing of overload warning and overload alarm based on the overload detection level of the motor given in 7.2.6 *Servomotor Overload Protection Characteristics* on page 7-8.

Note: 1. Use the combination of the SERVOPACK and Servomotor so that the derating conditions are satisfied for both the SERVOPACK and Servomotor.

2. The derating rates are applicable only when the average motor speed is less than or equal to the rated motor speed. If the average motor speed exceeds the rated motor speed, consult with your Yaskawa representative.

7.3 External Dimensions

7.3.1 Servomotors without Holding Brakes

SGM7G-03 and -05

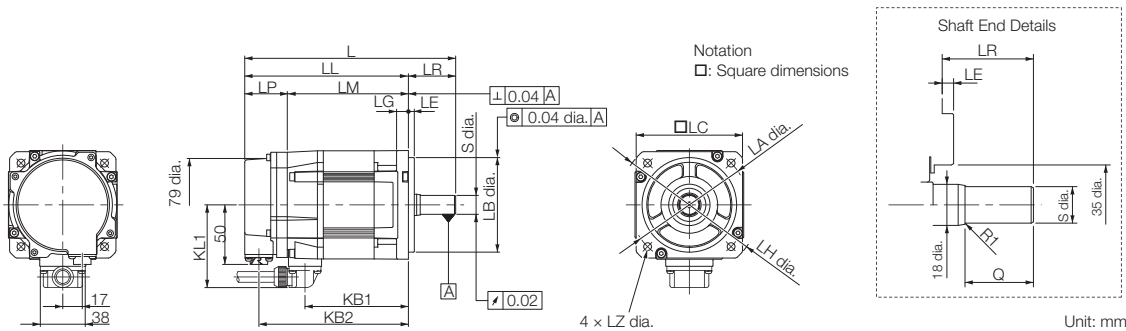

Model SGM7G-	L*1	LL*1	LM	LP*1	LR	KB1	KB2*1	KL1	Flange Dimensions			
									LA	LB	LC	LE
03A□A21	166*2	126	90	36	40*2	75	114	70	100	80 ⁰ _{-0.030}	90	5
05A□A21	179	139	103	36	40	88	127	70	100	80 ⁰ _{-0.030}	90	5

Model SGM7G-	Flange Dimensions			Shaft End Dimensions		Approx. Mass [kg]
	LG	LH	LZ	S	Q	
03A□A21	10	120	6.6	16 ⁰ _{-0.011} *2	30*2	2.6
05A□A21	10	120	6.6	16 ⁰ _{-0.011}	30	3.2

*1. For models that have a batteryless absolute encoder, L, LL, LP, and KB2 are 8 mm greater than the given value. Refer to the following section for the values for individual models.

Dimensions of Servomotors with Batteryless Absolute Encoders on page 7-18

*2. The L, LR, S, and Q dimensions of these Servomotors are different from those of the Σ-V-series SGMGV Servomotors.

Models that have the same installation dimensions as the SGMGV Servomotors are also available. Contact your Yaskawa representative for details.

Note: 1. The dimensions are same for models with oil seals.

2. The values for a straight, without key specification are given. Refer to the information given below for other shaft end specifications and option specifications.

◆ Shaft End Specifications

- Straight with Key and Tap

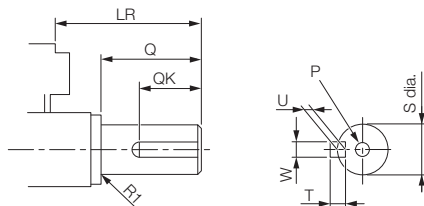

Model SGM7G-	LR	Q	QK	S	W	T	U	P
03A□A61	40*	30*	20*	16 ⁰ _{-0.011} *	5	5	3	M5×12L
05A□A61	40	30	20	16 ⁰ _{-0.011}	5	5	3	

* The shaft end dimensions of these Servomotors are different from those of the Σ-V-series SGMGV Servomotors.

Models that have the same installation dimensions as the SGMGV Servomotors are also available. Contact your Yaskawa representative for details.

◆ Connector Specifications

- Encoder Connector (24-bit Encoder)

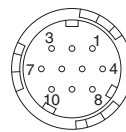

1	PS	6*	BAT(+)
2	/PS	7	-
3	-	8	-
4	PG5V	9	PG0V
5*	BAT(-)	10	FG (frame ground)

* A battery is required only for an absolute encoder.

Receptacle: CM10-R10P-D

Applicable plug: Not provided by Yaskawa.

Plug: CM10-AP10S-□-D for Right-angle Plug

CM10-SP10S-□-D for Straight Plug

(□ depends on the applicable cable size.)

Manufacturer: DDK Ltd.

- Servomotor Connector

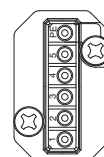

PE	FG (frame ground)	3	Phase U
5	-	2	Phase V
4	-	1	Phase W

Manufacturer: Japan Aviation Electronics Industry, Ltd.

7.3 External Dimensions

7.3.1 Servomotors without Holding Brakes

SGM7G-09 to -75

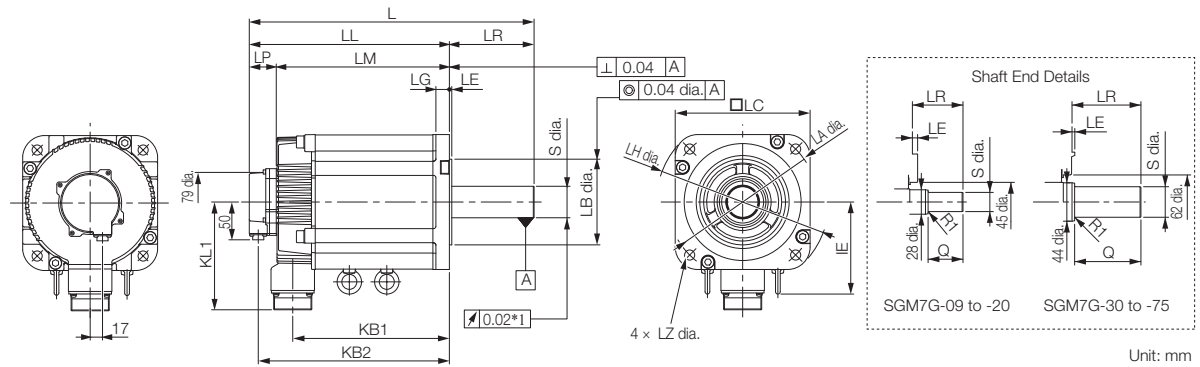

Model SGM7G-	L*2	LL*2	LM	LP*2	LR	KB1	KB2*2	IE	KL1	Flange Dimensions						Shaft End Dimensions		Approx. Mass [kg]	
										LA	LB	LC	LE	LG	LH	LZ	S		Q
09A□A21	195	137	101	36	58	83	125	-	104	145	110 ⁰ _{-0.035}	130	6	12	165	9	24 ⁰ _{-0.013} *3	40	5.5
13A□A21	211	153	117	36	58	99	141	-	104	145	110 ⁰ _{-0.035}	130	6	12	165	9	24 ⁰ _{-0.013} *3	40	7.1
20A□A21	229	171	135	36	58	117	159	-	104	145	110 ⁰ _{-0.035}	130	6	12	165	9	24 ⁰ _{-0.013}	40	8.6
30A□A21	239	160	124	36	79	108	148	-	134	200	114.3 ⁰ _{-0.025}	180	3.2	18	230	13.5	35 ^{+0.01} ₀	76	13.5
44A□A21	263	184	148	36	79	132	172	-	134	200	114.3 ⁰ _{-0.025}	180	3.2	18	230	13.5	35 ^{+0.01} ₀	76	17.5
55A□A21	334	221	185	36	113	163	209	123	144	200	114.3 ⁰ _{-0.025}	180	3.2	18	230	13.5	42 ⁰ _{-0.016}	110	21.5
75A□A21	380	267	231	36	113	209	255	123	144	200	114.3 ⁰ _{-0.025}	180	3.2	18	230	13.5	42 ⁰ _{-0.016}	110	29.5

*1. This is 0.04 for the SGM7G-55 or SGM7G-75.

*2. For models that have a batteryless absolute encoder, L, LL, LP, and KB2 are 8 mm greater than the given value. Refer to the following section for the values for individual models.

Dimensions of Servomotors with Batteryless Absolute Encoders on page 7-18

*3. The S dimensions of these Servomotors are different from those of the Σ-V-series SGMGV Servomotors. Models that have the same installation dimensions as the SGMGV Servomotors are also available. Contact your Yaskawa representative for details.

Note: 1. The dimensions are same for models with oil seals.

2. The values for a straight, without key specification are given. Refer to the information given below for other shaft end specifications and option specifications.

◆ Shaft End Specifications

- Straight with Key and Tap

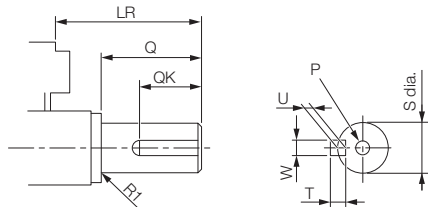

Model SGM7G-	LR	Q	QK	S	W	T	U	P
09A□A61	58	40	25	24 ⁰ _{-0.013} * 8*	8*	7*	4*	M5×12L
13A□A61	58	40	25	24 ⁰ _{-0.013} * 8*	8*	7*	4*	
20A□A61	58	40	25	24 ⁰ _{-0.013}	8	7	4	
30A□A61	79	76	60	35 ^{+0.01} ₀	10	8	5	M12×25L
44A□A61	79	76	60	35 ^{+0.01} ₀	10	8	5	
55A□A61	113	110	90	42 ⁰ _{-0.016}	12	8	5	M16×32L
75A□A61	113	110	90	42 ⁰ _{-0.016}	12	8	5	

* The shaft end dimensions of these Servomotors are different from those of the Σ-V-series SGMGV Servomotors. Models that have the same installation dimensions as the SGMGV Servomotors are also available. Contact your Yaskawa representative for details.

◆ Connector Specifications

- Encoder Connector (24-bit Encoder)

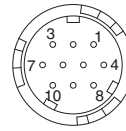

1	PS	6*	BAT(+)
2	/PS	7	-
3	-	8	-
4	PG5V	9	PG0V
5*	BAT(-)	10	FG (frame ground)

* A battery is required only for an absolute encoder.

Receptacle: CM10-R10P-D

Applicable plug: Not provided by Yaskawa.

Plug: CM10-AP10S-□-D for Right-angle Plug

CM10-SP10S-□-D for Straight Plug

(□ depends on the applicable cable size.)

Manufacturer: DDK Ltd.

- Servomotor Connector

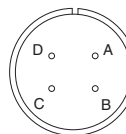

A	Phase U	C	Phase W
B	Phase V	D	FG (frame ground)

Manufacturer: DDK Ltd.

SGM7G-1A and -1E

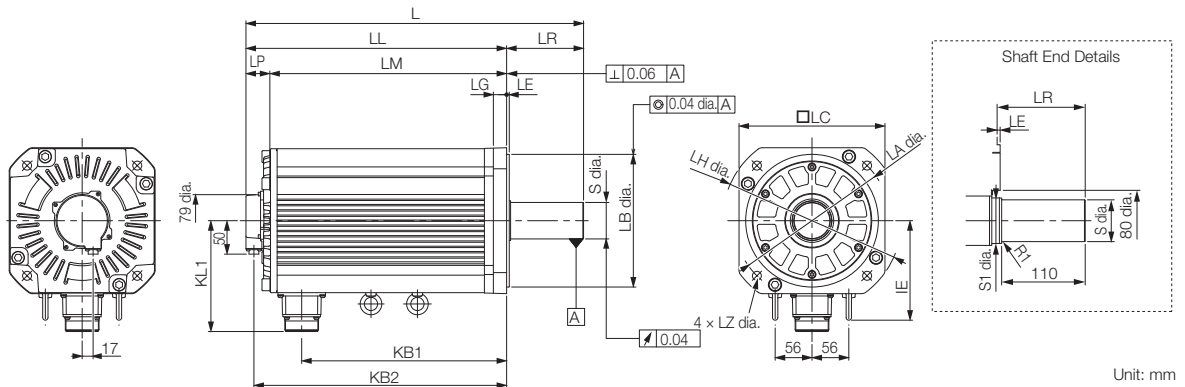

Unit: mm

Model SGM7G-	L*	LL*	LM	LP*	LR	KB1	KB2*	IE	KL1	Flange Surface Dimensions						Shaft End Dimensions		Approx. Mass [kg]	
										LA	LB	LC	LE	LG	LH	LZ	S		S1
1AA□A21	447	331	295	36	116	247	319	150	168	235	200 ⁰ _{-0.046}	220	4	20	270	13.5	42 ⁰ _{-0.016}	50	57
1EA□A21	509	393	357	36	116	309	381	150	168	235	200 ⁰ _{-0.046}	220	4	20	270	13.5	55 ^{+0.030} _{+0.011}	60	67

* For models that have a batteryless absolute encoder, L, LL, LP, and KB2 are 8 mm greater than the given value. Refer to the following section for the values for individual models.

Dimensions of Servomotors with Batteryless Absolute Encoders on page 7-18

Note: 1. The dimensions are same for models with oil seals.

2. The values for a straight, without key specification are given. Refer to the information given below for other shaft end specifications and option specifications.

◆ Shaft End Specifications

- Straight with Key and Tap

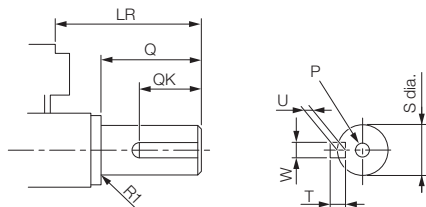

Model SGM7G-	LR	Q	QK	S	W	T	U	P
1AA□A61	116	110	90	42 ⁰ _{-0.016}	12	8	5	M16×32L
1EA□A61	116	110	90	55 ^{+0.030} _{+0.011}	16	10	6	M20×40L

◆ Connector Specifications

- Encoder Connector (24-bit Encoder)

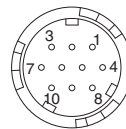

1	PS	6*	BAT(+)
2	/PS	7	-
3	-	8	-
4	PG5V	9	PG0V
5*	BAT(-)	10	FG (frame ground)

* A battery is required only for an absolute encoder.
 Receptacle: CM10-R10P-D
 Applicable plug: Not provided by Yaskawa.
 Plug: CM10-AP10S-□-D for Right-angle Plug
 CM10-SP10S-□-D for Straight Plug
 (□ depends on the applicable cable size.)
 Manufacturer: DDK Ltd.

- Servomotor Connector

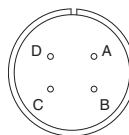

A	Phase U	C	Phase W
B	Phase V	D	FG (frame ground)

Manufacturer: DDK Ltd.

7.3.2 Servomotors with Holding Brakes

SGM7G-03 and -05

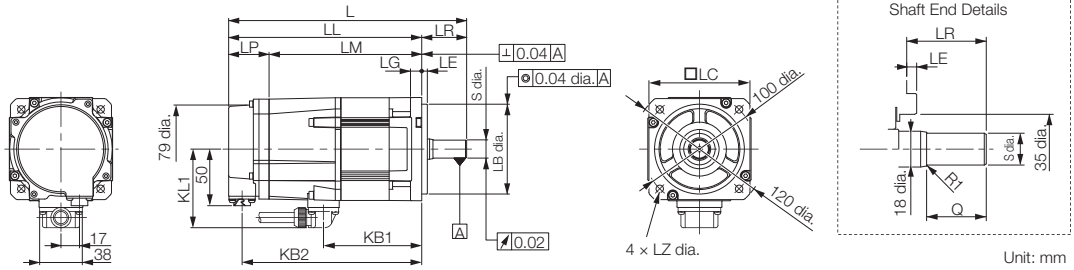

Model SGM7G-	L* ¹	LL* ¹	LM	LP* ¹	LR	KB1	KB2* ¹	KL1
03A□A2C	199* ²	159	123	36	40* ²	75	147	70
05A□A2C	212	172	136	36	40	88	160	70

Model SGM7G-	Flange Dimensions							Shaft End Dimensions		Approx. Mass [kg]
	LA	LB	LC	LE	LG	LH	LZ	S	Q	
03A□A2C	100	80 ⁰ _{-0.030}	90	5	10	120	6.6	16 ⁰ _{-0.011} * ²	30* ²	3.6
05A□A2C	100	80 ⁰ _{-0.030}	90	5	10	120	6.6	16 ⁰ _{-0.011}	30	4.2

*1. For models that have a batteryless absolute encoder, L, LL, LP, and KB2 are 8 mm greater than the given value. Refer to the following section for the values for individual models.

Dimensions of Servomotors with Batteryless Absolute Encoders on page 7-18

*2. The L, LR, S, and Q dimensions of these Servomotors are different from those of the Σ-V-series SGMGV Servomotors.

Models that have the same installation dimensions as the SGMGV Servomotors are also available. Contact your Yaskawa representative for details.

Note: 1. The dimensions are same for models with oil seals.

2. The values for a straight, without key specification are given. Refer to the information given below for other shaft end specifications and option specifications.

◆ Shaft End Specifications

- Straight with Key and Tap

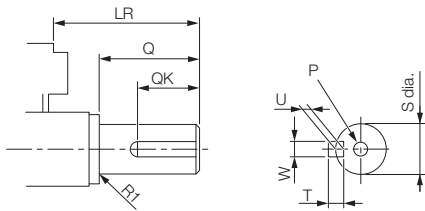

Model SGM7G-	LR	Q	QK	S	W	T	U	P
03A□A6C	40*	30*	20*	16 ⁰ _{-0.011} *	5	5	3	M5×12L
05A□A6C	40	30	20	16 ⁰ _{-0.011}	5	5	3	

* The shaft end dimensions of these Servomotors are different from those of the Σ-V-series SGMGV Servomotors.

Models that have the same installation dimensions as the SGMGV Servomotors are also available. Contact your Yaskawa representative for details.

◆ Connector Specifications

- Encoder Connector (24-bit Encoder)

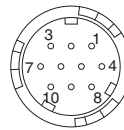

1	PS	6*	BAT(+)
2	/PS	7	-
3	-	8	-
4	PG5V	9	PG0V
5*	BAT(-)	10	FG (frame ground)

* A battery is required only for an absolute encoder.

Receptacle: CM10-R10P-D

Applicable plug: Not provided by Yaskawa.

Plug: CM10-AP10S-□-D for Right-angle Plug
CM10-SP10S-□-D for Straight Plug

(□ depends on the applicable cable size.)
Manufacturer: DDK Ltd.

- Servomotor Connector

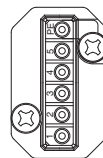

PE	FG (frame ground)	3	Phase U
5	-	2	Phase V
4	-	1	Phase W

Manufacturer: Japan Aviation Electronics Industry, Ltd.

SGM7G-09 to -75

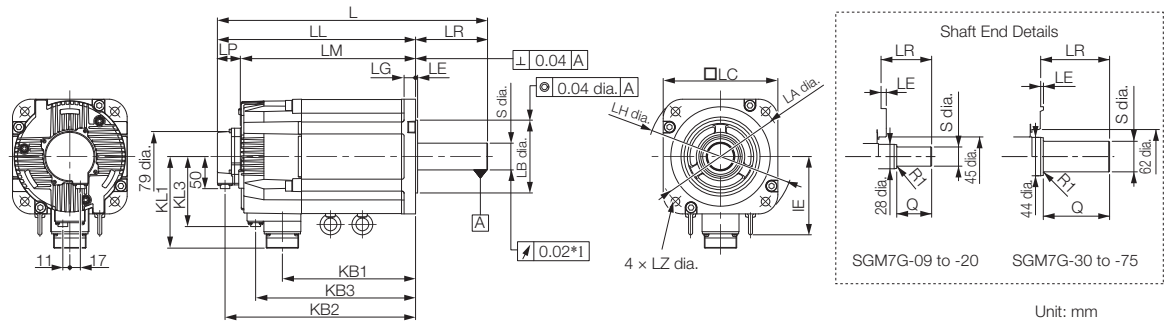

Model SGM7G-	L ^{*2}	LL ^{*2}	LM	LP ^{*2}	LR	KB1	KB2 ^{*2}	KB3	IE	KL1	KL3	Flange Surface Dimensions						Shaft End Dimensions		Approx. Mass [kg]	
												LA	LB	LC	LE	LG	LH	LZ	S		Q
09A□A2C	231	173	137	36	58	83	161	115	-	104	80	145	110 ⁰ _{-0.035}	130	6	12	165	9	24 ⁰ _{-0.013} ^{*3}	40	7.5
13A□A2C	247	189	153	36	58	99	177	131	-	104	80	145	110 ⁰ _{-0.035}	130	6	12	165	9	24 ⁰ _{-0.013} ^{*3}	40	9.0
20A□A2C	265	207	171	36	58	117	195	149	-	104	80	145	110 ⁰ _{-0.035}	130	6	12	165	9	24 ⁰ _{-0.013}	40	11.0
30A□A2C	287	208	172	36	79	108	196	148	-	134	110	200	114.3 ⁰ _{-0.025}	180	3.2	18	230	13.5	35 ^{+0.01} ₀	76	19.5
44A□A2C	311	232	196	36	79	132	220	172	-	134	110	200	114.3 ⁰ _{-0.025}	180	3.2	18	230	13.5	35 ^{+0.01} ₀	76	23.5
55A□A2C	378	265	229	36	113	163	253	205	123	144	110	200	114.3 ⁰ _{-0.025}	180	3.2	18	230	13.5	42 ⁰ _{-0.016}	110	27.5
75A□A2C	424	311	275	36	113	209	299	251	123	144	110	200	114.3 ⁰ _{-0.025}	180	3.2	18	230	13.5	42 ⁰ _{-0.016}	110	35.0

*1. This is 0.04 for the SGM7G-55 or SGM7G-75.

*2. For models that have a batteryless absolute encoder, L, LL, LP, and KB2 are 8 mm greater than the given value. Refer to the following section for the values for individual models.

Dimensions of Servomotors with Batteryless Absolute Encoders on page 7-18

*3. The S dimensions of these Servomotors are different from those of the Σ-V-series SGMGV Servomotors. Models that have the same installation dimensions as the SGMGV Servomotors are also available. Contact your Yaskawa representative for details.

Note: 1. The dimensions are same for models with oil seals.

2. The values for a straight, without key specification are given. Refer to the information given below for other shaft end specifications and option specifications.

◆ Shaft End Specifications

- Straight with Key and Tap

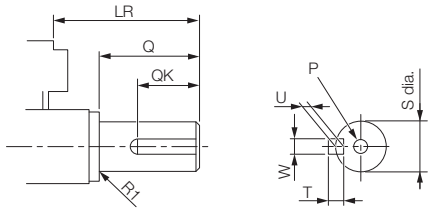

Model SGM7G-	LR	Q	QK	S	W	T	U	P
09A□A6C	58	40	25	24 ⁰ _{-0.013} *	8*	7*	4*	M5×12L
13A□A6C	58	40	25	24 ⁰ _{-0.013} *	8*	7*	4*	
20A□A6C	58	40	25	24 ⁰ _{-0.013}	8	7	4	
30A□A6C	79	76	60	35 ^{+0.01} ₀	10	8	5	M12×25L
44A□A6C	79	76	60	35 ^{+0.01} ₀	10	8	5	
55A□A6C	113	110	90	42 ⁰ _{-0.016}	12	8	5	M16×32L
75A□A6C	113	110	90	42 ⁰ _{-0.016}	12	8	5	

* The shaft end dimensions of these Servomotors are different from those of the Σ-V-series SGMGV Servomotors. Models that have the same installation dimensions as the SGMGV Servomotors are also available. Contact your Yaskawa representative for details.

◆ Connector Specifications

- Encoder Connector (24-bit Encoder)

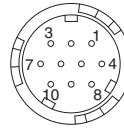

1	PS	6*	BAT(+)
2	/PS	7	-
3	-	8	-
4	PG5V	9	PG0V
5*	BAT(-)	10	FG (frame ground)

* A battery is required only for an absolute encoder.
 Receptacle: CM10-R10P-D
 Applicable plug: Not provided by Yaskawa.
 Plug: CM10-AP10S-□-D for Right-angle Plug
 CM10-SP10S-□-D for Straight Plug
 (□ depends on the applicable cable size.)
 Manufacturer: DDK Ltd.

- Servomotor Connector

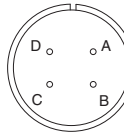

A	Phase U	C	Phase W
B	Phase V	D	FG (frame ground)

Manufacturer: DDK Ltd.

- Brake Connector

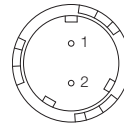

1	Brake terminal
2	Brake terminal

Note: There is no voltage polarity for the brake terminals.
 Receptacle: CM10-R2P-D
 Applicable plug: Not provided by Yaskawa.
 Plug: CM10-AP2S-□-D for Right-angle Plug
 CM10-SP2S-□-D for Straight Plug
 (□ depends on the applicable cable size.)
 Manufacturer: DDK Ltd.

SGM7G-1A and -1E

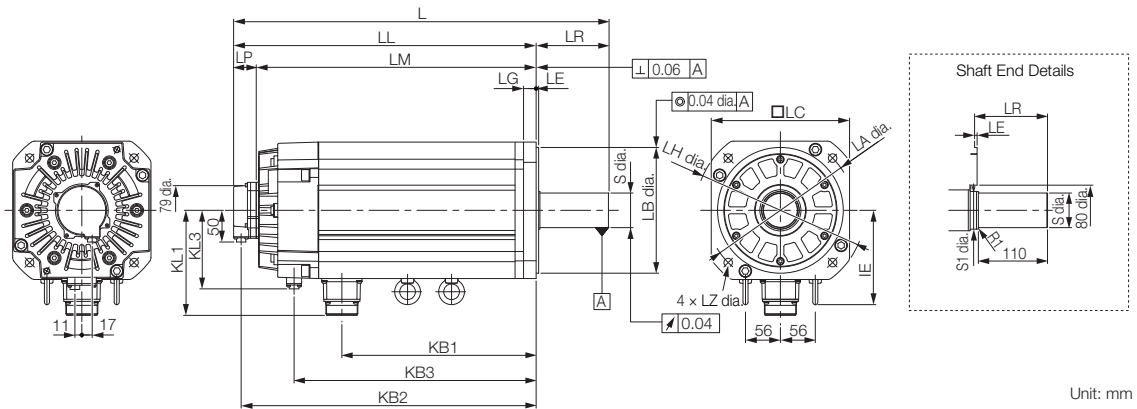

Model SGM7G-	L*	LL*	LM	LP*	LR	KB1	KB2*	KB3	IE	KL1	KL3	Flange Surface Dimensions						Shaft End Dimensions		Approx. Mass [kg]	
												LA	LB	LC	LE	LG	LH	LZ	S		S1
1AA□A2C	498	382	346	36	116	247	370	315	150	168	125	235	200 0 -0.046	220	4	20	270	13.5	42 ⁰ _{-0.016}	50	65
1EA□A2C	598	482	446	36	116	309	470	385	150	168	125	235	200 0 -0.046	220	4	20	270	13.5	55 ^{+0.030} _{+0.011}	60	85

* For models that have a batteryless absolute encoder, L, LL, LP, and KB2 are 8 mm greater than the given value. Refer to the following section for the values for individual models.

Dimensions of Servomotors with Batteryless Absolute Encoders on page 7-18

Note: 1. The dimensions are same for models with oil seals.

2. The values for a straight, without key specification are given. Refer to the information given below for other shaft end specifications and option specifications.

◆ Shaft End Specifications

- Straight with Key and Tap

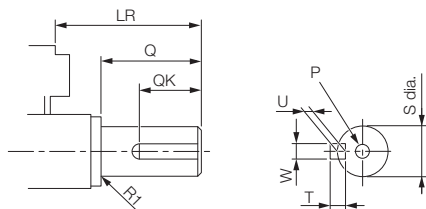

Model SGM7G-	LR	Q	QK	S	W	T	U	P
1AA□A6C	116	110	90	42 ⁰ _{-0.016}	12	8	5	M16×32L
1EA□A6C	116	110	90	55 ^{+0.030} _{+0.011}	16	10	6	M20×40L

◆ Connector Specifications

- Encoder Connector (24-bit Encoder)

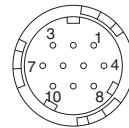

1	PS	6*	BAT(+)
2	/PS	7	-
3	-	8	-
4	PG5V	9	PG0V
5*	BAT(-)	10	FG (frame ground)

* A battery is required only for an absolute encoder.
 Receptacle: CM10-R10P-D
 Applicable plug: Not provided by Yaskawa.
 Plug: CM10-AP10S-□-D for Right-angle Plug
 CM10-SP10S-□-D for Straight Plug
 (□ depends on the applicable cable size.)
 Manufacturer: DDK Ltd.

- Servomotor Connector

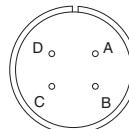

A	Phase U	C	Phase W
B	Phase V	D	FG (frame ground)

Manufacturer: DDK Ltd.

- Brake Connector

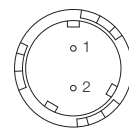

1	Brake terminal
2	Brake terminal

Note: There is no voltage polarity for the brake terminals.
 Receptacle: CM10-R10P-D
 Applicable plug: Not provided by Yaskawa.
 Plug: CM10-AP2S-□-D for Right-angle Plug
 CM10-SP2S-□-D for Straight Plug
 (□ depends on the applicable cable size.)
 Manufacturer: DDK Ltd.

Dimensions of Servomotors with Batteryless Absolute Encoders

◆ Servomotors without Holding Brakes

Model SGM7G-	L	LL	LP	KB2	Approx. Mass [kg]
03A6A21	174	134	44	122	2.6
05A6A21	187	147	44	135	3.2
09A6A21	203	145	44	133	5.5
13A6A21	219	161	44	149	7.1
20A6A21	237	179	44	167	8.6
30A6A21	247	168	44	156	13.5
44A6A21	271	192	44	180	17.5
55A6A21	342	229	44	217	21.5
75A6A21	388	275	44	264	29.5
1AA6A21	455	339	44	327	57
1EA6A21	514	401	44	389	67

◆ Servomotors with Holding Brakes

Model SGM7G-	L	LL	LP	KB2	Approx. Mass [kg]
03A6A2C	207	167	44	155	3.6
05A6A2C	220	180	44	168	4.2
09A6A2C	239	181	44	169	7.5
13A6A2C	255	197	44	185	9.0
20A6A2C	273	215	44	203	11
30A6A2C	295	216	44	204	19.5
44A6A2C	319	240	44	228	23.5
55A6A2C	386	273	44	261	27.5
75A6A2C	432	319	44	307	35.0
1AA6A2C	506	390	44	378	65
1EA6A2C	606	490	44	478	85

Specifications, Ratings, and External Dimensions of SGMMV Servomotors

8

This chapter describes how to interpret the model numbers of SGMMV Servomotors and gives their specifications, ratings, and external dimensions.

8.1	Model Designations	8-2
8.2	Specifications and Ratings	8-3
8.2.1	Specifications	8-3
8.2.2	Servomotor Ratings	8-4
8.2.3	Torque-Motor Speed Characteristics	8-5
8.2.4	Servomotor Overload Protection Characteristics	8-5
8.2.5	Allowable Load Moment of Inertia	8-6
8.2.6	Derating Rates	8-7
8.3	External Dimensions	8-8
8.3.1	Servomotors without Holding Brakes	8-8
8.3.2	Servomotors with Holding Brakes	8-9

8.1 Model Designations

SGMMV - A1 A 2 A 2 1

1st+2nd digits
3rd digit
4th digit
5th digit
6th digit
7th digit

Σ-V mini Series
Servomotors:
SGMMV

1st+2nd digits Rated Output

Code	Specification
A1	10 W
A2	20 W
A3	30 W

3rd digit Power Supply Voltage

Code	Specification
A	200 VAC

4th digit Serial Encoder

Code	Specification
2	17-bit absolute

5th digit Design Revision Order

A

6th digit Shaft End

Code	Specification
2	Straight
A	Straight with flat seats

7th digit Options

Code	Specification
1	Without options
C	With holding brake (24 VDC)

8.2 Specifications and Ratings

8.2.1 Specifications

Voltage		200 V		
Model SGMMV-		A1A	A2A	A3A
Time Rating		Continuous		
Thermal Class		B		
Insulation Resistance		500 VDC, 10 M Ω min.		
Withstand Voltage		1,500 VAC for 1 minute		
Excitation		Permanent magnet		
Mounting		Flange-mounted		
Drive Method		Direct drive		
Rotation Direction		Counterclockwise (CCW) for forward reference when viewed from the load side		
Vibration Class* ¹		V15		
Environmental Conditions	Surrounding Air Temperature	0°C to 40°C		
	Surrounding Air Humidity	20% to 80% relative humidity (with no condensation)		
	Installation Site	<ul style="list-style-type: none"> • Must be indoors and free of corrosive and explosive gases. • Must be well-ventilated and free of dust and moisture. • Must facilitate inspection and cleaning. • Must have an altitude of 1,000 m or less. • Must be free of strong magnetic fields. 		
	Storage Environment	Store the Servomotor in the following environment if you store it with the power cable disconnected. Storage temperature: -20°C to 60°C (with no freezing) Storage humidity: 20% to 80% relative humidity (with no condensation)		
Shock Resistance* ²	Impact Acceleration Rate at Flange	490 m/s ²		
	Number of Impacts	2 times		
Vibration Resistance* ²	Vibration Acceleration Rate at Flange	49 m/s ²		
Applicable SERVO-PACKs	SGD7S-	R90A, R90F		1R6A, 2R1F
	SGD7W-	1R6A* ³ , 2R8A* ³		1R6A, 2R8A* ³
	SGD7C-			

*1. A vibration class of V15 indicates a vibration amplitude of 15 μ m maximum on the Servomotor without a load at the rated motor speed.

*2. The given values are for when the Servomotor shaft is mounted horizontally and shock or vibration is applied in the directions shown in the following figures.

The strength of the vibration that the Servomotor can withstand depends on the application. Always check the vibration acceleration rate that is applied to the Servomotor with the actual equipment.

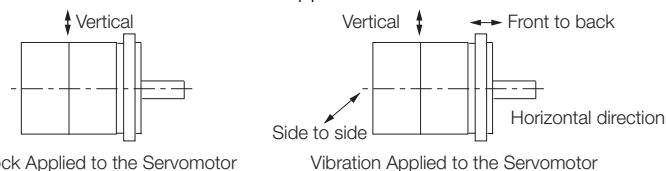

*3. If you use the Servomotor together with a Σ -7W or Σ -7C SERVOPACK, the control gain may not increase as much as with a Σ -7S SERVOPACK and other performances may be lower than those achieved with a Σ -7S SERVOPACK.

8.2.2 Servomotor Ratings

Voltage		200 V			
Model SGMMV-		A1A	A2A	A3A	
Rated Output* ¹	W	10	20	30	
Rated Torque* ^{1, *2}	N·m	0.0318	0.0637	0.0955	
Instantaneous Maximum Torque* ¹	N·m	0.0955	0.191	0.286	
Rated Current* ¹	Arms	0.70	0.66	0.98	
Instantaneous Maximum Current* ¹	Arms	2.0	1.9	2.9	
Rated Motor Speed* ¹	min ⁻¹	3000			
Maximum Motor Speed* ¹	min ⁻¹	6000			
Torque Constant	N·m/Arms	0.0516	0.107	0.107	
Motor Moment of Inertia	×10 ⁻⁷ kg·m ²	2.72 (4.07)	4.66 (6.02)	6.68 (8.04)	
Rated Power Rate* ¹	kW/s	3.72	8.71	13.7	
Rated Angular Acceleration Rate* ¹	rad/s ²	117000	137000	143000	
Heat Sink Size (Aluminum)* ³	mm	150 × 150 × 3		250 × 250 × 6	
Protective Structure* ⁴	Totally enclosed, self-cooled, IP55 (except for shaft opening)				
Holding Brake Specifications* ⁵	Rated Voltage	V	24 VDC ^{+10%} ₀		
	Capacity	W	2.0	2.6	
	Holding Torque	N·m	0.0318	0.0637	0.0955
	Coil Resistance	Ω (at 20°C)	320	221.5	
	Rated Current	A (at 20°C)	0.075	0.108	
	Time Required to Release Brake	ms	40		
	Time Required to Brake	ms	100		
Allowable Load Moment of Inertia (Motor Moment of Inertia Ratio)* ⁶	30 times				
	With External Regenerative Resistor	30 times			
Allowable Shaft Loads* ⁷	LF	mm	16		
	Allowable Radial Load	N	34	44	
	Allowable Thrust Load	N	14.5		

Note: The values in parentheses are for Servomotors with Holding Brakes.

- *1. These values are for operation in combination with a SERVOPACK when the temperature of the armature winding is 100°C. These are typical values.
- *2. The rated torques are the continuous allowable torque values with an aluminum or steel heat sink of the dimensions given in the table.
- *3. Refer to the following section for the relation between the heat sinks and derating rate.
 **Servomotor Heat Dissipation Conditions** on page 8-7
- *4. This does not apply to the shaft opening. Protective structure specifications apply only when the special cable is used.
- *5. Observe the following precautions if you use a Servomotor with a Holding Brake.
 - The holding brake cannot be used to stop the Servomotor.
 - The time required to release the brake and the time required to brake depend on which discharge circuit is used. Confirm that the operation delay time is appropriate for the actual equipment.
 - The 24-VDC power supply is not provided by Yaskawa.
- *6. The motor moment of inertia scaling factor is the value for a standard Servomotor without a Holding Brake.
- *7. Design the mechanical system so that the thrust and radial loads applied to the Servomotor shaft end during operation do not exceed the values given in the table.

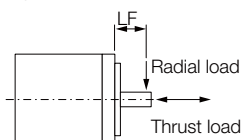

8.2.3 Torque-Motor Speed Characteristics

- A** : Continuous duty zone
- B** : Intermittent duty zone*

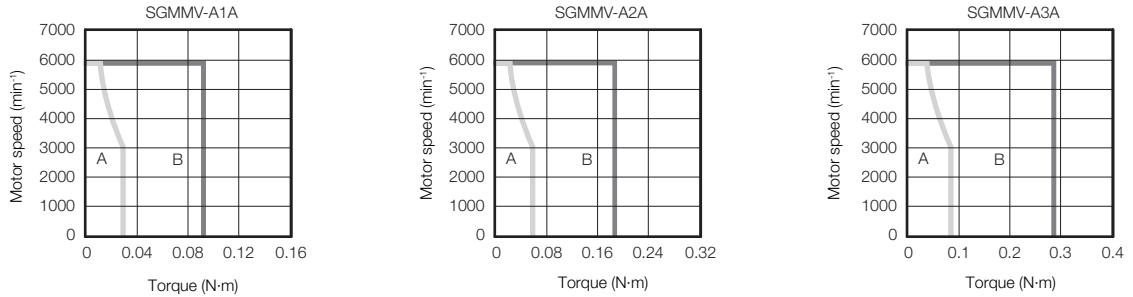

* The characteristics are the same for three-phase 200 V, single-phase 200 V, and single-phase 100 V input.

Note: 1. These values (typical values) are for operation in combination with a SERVOPACK when the temperature of the armature winding is 100°C.

2. The characteristics in the intermittent duty zone depend on the power supply voltage.
3. If the effective torque is within the allowable range for the rated torque, the Servomotor can be used within the intermittent duty zone.
4. If you use a Servomotor Main Circuit Cable that exceeds 20 m, the intermittent duty zone in the torque-motor speed characteristics will become smaller because the voltage drop increases.

8.2.4 Servomotor Overload Protection Characteristics

The overload detection level is set for hot start conditions with a Servomotor surrounding air temperature of 40°C.

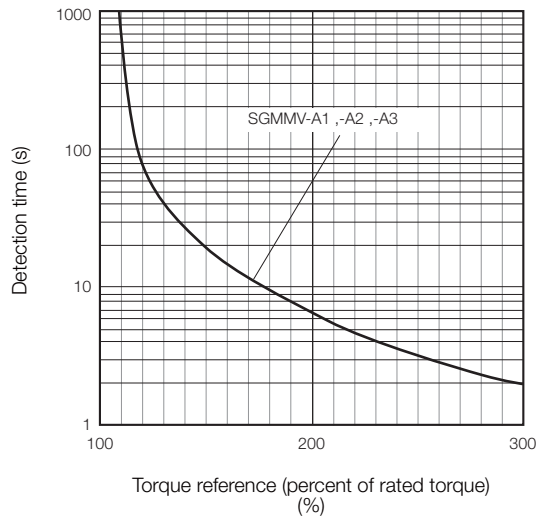

Note: The above overload protection characteristics do not mean that you can perform continuous duty operation with an output of 100% or higher. Use the Servomotor so that the effective torque remains within the continuous duty zone given in 8.2.3 Torque-Motor Speed Characteristics on page 8-5.

8.2.5 Allowable Load Moment of Inertia

The allowable load moments of inertia (motor moment of inertia ratios) for the Servomotors are given in 8.2.2 *Servomotor Ratings* on page 8-4. The values are determined by the regenerative energy processing capacity of the SERVOPACK and are also affected by the drive conditions of the Servomotor. Perform the required Steps for each of the following cases.

Use the SigmaSize+ AC Servo Drive Capacity Selection Program to check the driving conditions. Contact your Yaskawa representative for information on this program.

Exceeding the Allowable Load Moment of Inertia

Use one of the following measures to adjust the load moment of inertia to within the allowable value.

- Reduce the torque limit.
- Reduce the deceleration rate.
- Reduce the maximum motor speed.

If the above steps is not possible, install an external regenerative resistor.

Information An Overvoltage Alarm (A.400) is likely to occur during deceleration if the load moment of inertia exceeds the allowable load moment of inertia. SERVOPACKs with a built-in regenerative resistor may generate a Regenerative Overload Alarm (A.320). Refer to the following catalog for the regenerative power (W) that can be processed by the SERVOPACKs.
📖 AC Servo Drives Σ -7 Series Product Catalog (Document No.: KAEP S800001 23)
Install an External Regenerative Resistor when the built-in regenerative resistor cannot process all of the regenerative power.

SERVOPACKs without Built-in Regenerative Resistors

The following graph shows the allowable load moment of inertia scaling factor of the motor speed (reference values for deceleration operation at or above the rated torque). Application is possible without an external regenerative resistor within the allowable value. However, an External Regenerative Resistor is required in the shaded areas of the graphs.

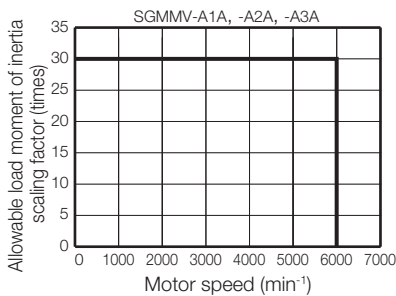

Note: Applicable SERVOPACK models: SGD7S-R90A, -1R6A, -R90F, and -2R1F

When an External Regenerative Resistor Is Required

Install the External Regenerative Resistor. Refer to the following catalog for the recommended products.

📖 AC Servo Drives Σ -7 Series Product Catalog (Document No.: KAEP S800001 23)

8.2.6 Derating Rates

Servomotor Heat Dissipation Conditions

The Servomotor ratings are the continuous allowable values when a heat sink is installed on the Servomotor. If the Servomotor is mounted on a small device component, the Servomotor temperature may rise considerably because the surface for heat dissipation becomes smaller. Refer to the following graphs for the relation between the heat sink size and derating rate.

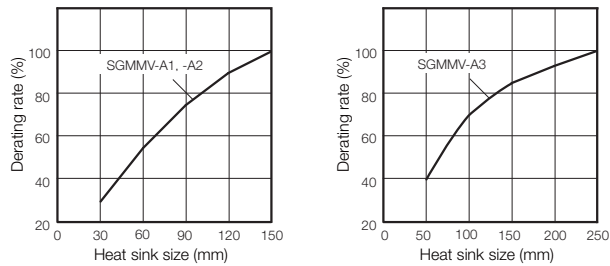

Important

The actual temperature rise depends on the following conditions. Always check the Servomotor temperature with the actual equipment.

- How the heat sink (the Servomotor mounting section) is attached to the installation surface
- Status between heat sink and Servomotor (sealant, reduction gear, etc.)
- What material is used for the Servomotor mounting section
- Servomotor speed

Information

When using Servomotors with derating, change the detection timing of overload warning and overload alarm based on the overload detection level of the motor given in 8.2.4 *Servomotor Overload Protection Characteristics* on page 8-5.

Note: The derating rates are applicable only when the average motor speed is less than or equal to the rated motor speed. If the average motor speed exceeds the rated motor speed, consult with your Yaskawa representative.

8.3 External Dimensions

8.3.1 Servomotors without Holding Brakes

SGMMV-A1, -A2 and -A3

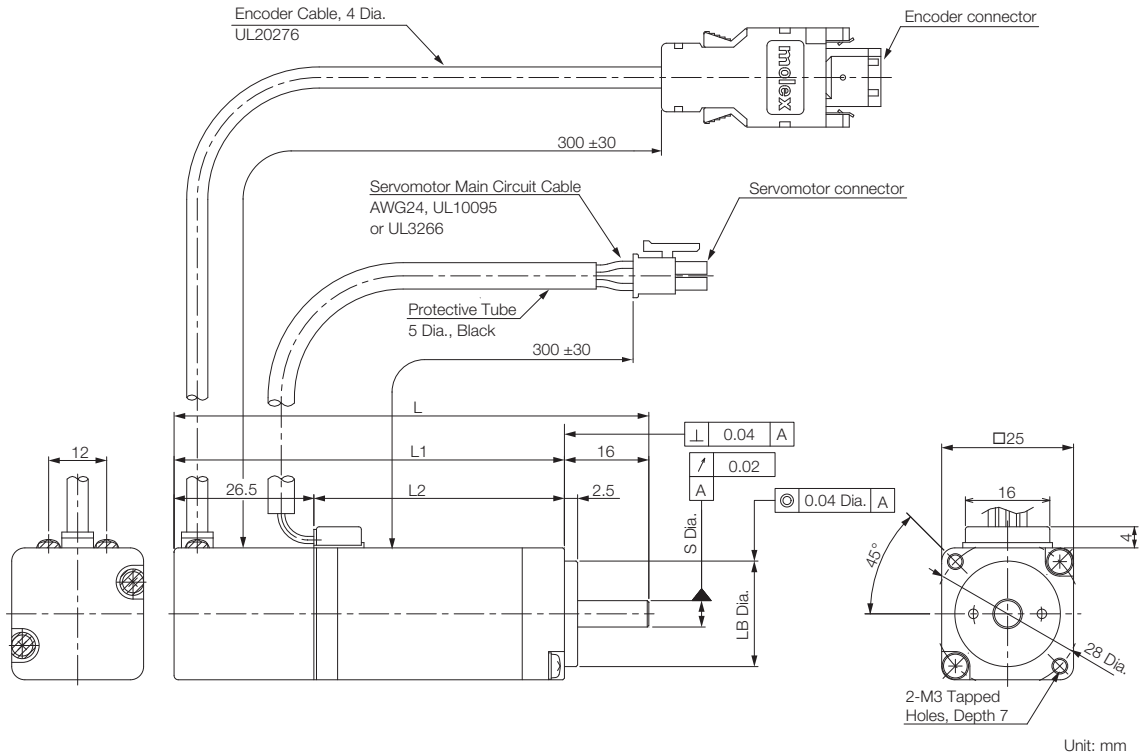

Model SGMMV-	L	L1	L2	Flange Dimensions		Approx. Mass [kg]
				S	LB	
A1A2A□1	70	54	27.5	5 ⁰ _{-0.008}	20 ⁰ _{-0.021}	0.13
A2A2A□1	80	64	37.5	5 ⁰ _{-0.008}	20 ⁰ _{-0.021}	0.17
A3A2A□1	90	74	47.5	5 ⁰ _{-0.008}	20 ⁰ _{-0.021}	0.21

◆ Shaft End Specification

- Straight with Flat Seats

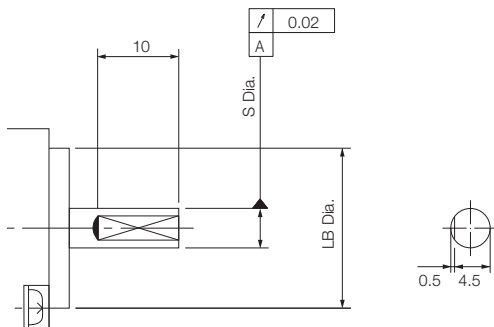

◆ Connector Specifications

- Encoder Connector

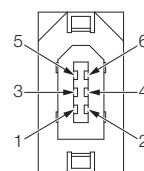

1	PG5V	Red
2	PG0V	Black
3*	BAT	Orange
4*	BATO	Orange/white
5	PS	Light blue
6	/PS	Light blue/white
Connector case	FG (frame ground)	Shield

* A battery is required only for an absolute encoder.

Model: 55102-0600

Manufacturer: Molex Japan LLC

Mating connector: 54280-0609

- Servomotor Connector

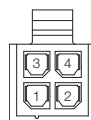

1	Phase U
2	Phase V
3	Phase W
4	FG (frame ground)

Receptacle: 43025-0400

Manufacturer: Molex Japan LLC

8.3.2 Servomotors with Holding Brakes

SGMMV-A1, -A2 and -A3

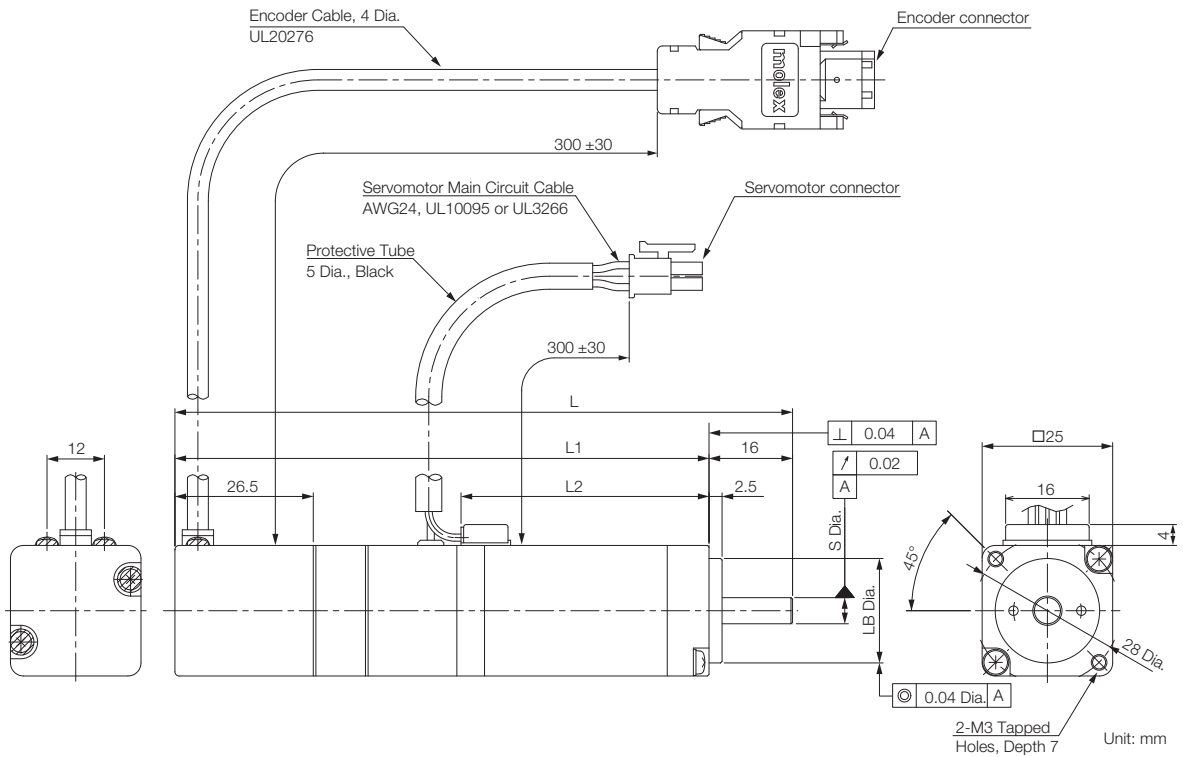

Model SGMMV-	L	L1	L2	Flange Dimensions		Approx. Mass [kg]
				S	LB	
A1A2A□□	94.5	78.5	27.5	5 ⁰ _{-0.008}	20 ⁰ _{-0.021}	0.215
A2A2A□□	108.5	92.5	37.5	5 ⁰ _{-0.008}	20 ⁰ _{-0.021}	0.27
A3A2A□□	118.5	102.5	47.5	5 ⁰ _{-0.008}	20 ⁰ _{-0.021}	0.31

◆ Shaft End Specification

- Straight with Flat Seats

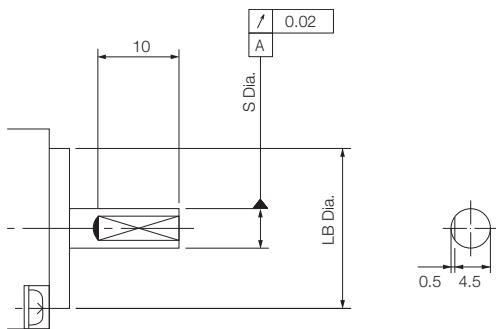

◆ Connector Specifications

- Encoder Connector

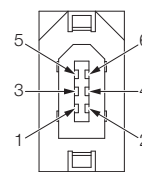

1	PG5V	Red
2	PG0V	Black
3*	BAT	Orange
4*	BAT0	Orange/white
5	PS	Light blue
6	/PS	Light blue/white
Connector case	FG (frame ground)	Shield

* A battery is required only for an absolute encoder.

Model: 55102-0600

Manufacturer: Molex Japan LLC

Mating connector: 54280-0609

- Servomotor Connector

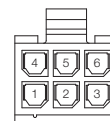

1	Phase U
2	Phase V
3	Phase W
4	FG (frame ground)
5	Brake
6	Brake

Receptacle: 43025-0600

Manufacturer: Molex Japan LLC

Servomotor Installation

9

This chapter describes the installation conditions, procedures, and precautions for Servomotors.

9.1	Installation Conditions	9-2
9.1.1	Installation Precautions	9-2
9.1.2	Installation Environment	9-3
9.1.3	Installation Orientation	9-3
9.1.4	Using Servomotors with Oil Seals	9-3
9.1.5	Using Servomotors with Holding Brakes	9-4
9.2	Coupling to the Machine	9-5
9.2.1	Using a Coupling	9-5
9.2.2	Using a Belt	9-6
9.3	Oil and Water Countermeasures	9-8
9.4	Servomotor Temperature Increase	9-9

9.1 Installation Conditions

The service life of a Servomotor will be shortened or unexpected problems will occur if the Servomotor is installed incorrectly or in an inappropriate environment or location. Always observe the following installation instructions.

9.1.1 Installation Precautions

- Use the lifting bolts on the Servomotor to move only the Servomotor. Never use the lifting bolts on the Servomotor to move the Servomotor while it is installed on the machine. There is a risk of damage to the Servomotor or injury.
- Do not over-tighten the lifting bolts. If you use a tool to over-tighten the lifting bolts, the tapped holes may be damaged.
- Do not hold onto the cables or motor shaft when you move the Servomotor. Doing so may result in injury or damage.
- Do not install the Servomotor in the following locations. Doing so may result in fire, electric shock, or damage.
 - Outdoors or in locations subject to direct sunlight
 - Locations subject to condensation as the result of extreme changes in temperature
 - Locations subject to corrosive or flammable gases or near flammable objects
 - Locations subject to dust, salts, or iron dust
 - Locations subject to oil drops or chemicals
 - Locations subject to shock or vibration
 - Locations that would make it difficult to inspect or clean the Servomotor
- Mount the Servomotor to the machine so that the cables and connectors are not subjected to stress.
- Implement suitable countermeasures, such as attaching a cover, if the Servomotor is used in an application where it is subject to excessive water or oil drops. We recommend that you keep the connectors facing downward.
- Do not connect a Servomotor with an Absolute Encoder or a Servomotor with a Batteryless Absolute Encoder in a location where there is a magnetic field with a magnetic flux density of 0.01 tesla (100 gauss) or higher.
- Mount the Servomotor securely to the machine. If the Servomotor is not mounted securely, the machine may be damaged or injury may occur.
- Do not step on or place a heavy object on the Servomotor. Doing so may result in injury.
- Do not allow any foreign matter to enter the Servomotor.
- For a Servomotor with a Cooling Fan, provide at least 200 mm of space around the fan inlet.
- To prevent electric shock, ground the Servomotor securely.
- Servomotors are precision devices. Never drop the Servomotor or subject it to strong shock.
- Implement safety measures, such as installing a cover, so that the motor shaft and other rotating parts of the Servomotor cannot be touched during operation.
- Continuous operation in one direction, such as for a fan, may damage the bearings due to electrolytic corrosion. Contact your Yaskawa representative if you use a Servomotor for this type of application.
- A Servomotor that has been stored for a long period of time must be inspected before it is used. Contact your Yaskawa representative for more information.
- Using a Servomotor for oscillating rotation may reduce the service life of the bearings. (Oscillating rotation is defined as a continuous forward-reverse operation within a 150° rotation angle of the motor shaft.) Rotate the Servomotor one full turn or more at least once a day.
- Never attempt to disassemble or modify a Servomotor.

9.1.2 Installation Environment

Refer to the specifications for each type of Servomotor for the mechanical specifications, protective structure, and environmental conditions related to Servomotor installation.

9.1.3 Installation Orientation

You can install the Servomotor either horizontally or vertically.

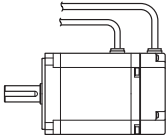
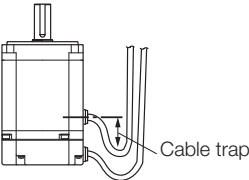
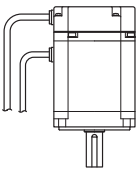
Installation Orientation	Figure	Precautions
Horizontal		If you are using a Servomotor with an Oil Seal, refer to the following section as well. ☞ 9.1.4 Using Servomotors with Oil Seals on page 9-3
Vertical	Shaft end up 	<ul style="list-style-type: none"> You cannot use a Servomotor with an Oil Seal in this orientation. Provide a cable trap so that water drops will not run into the Servomotor. Implement countermeasures in the machine so that oil, e.g., from a gear box, does not enter the Servomotor.
	Shaft end down 	If you are using a Servomotor with an Oil Seal, refer to the following section as well. ☞ 9.1.4 Using Servomotors with Oil Seals on page 9-3

Information

If you attach a gear to the Servomotor, observe the installation orientation specified by the manufacturer of the gear.

9.1.4 Using Servomotors with Oil Seals

This section gives the operating conditions for using Servomotors with Oil Seals.

- Keep the oil surface below the oil seal lip.

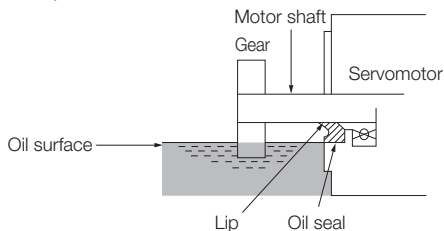

- Use the oil seal in favorably lubricated condition with only splashing of oil.
- Do not allow oil to collect in the oil seal lip.
- Do not use the Servomotor where the oil seal would be below the oil surface. If you do, oil will enter the Servomotor, which may damage the Servomotor.

9.1.5 Using Servomotors with Holding Brakes

This section gives precautions for using Servomotors with Holding Brakes

- The holding brakes have a limited service life. Although the quality and reliability of a holding brake has been sufficiently confirmed, stress factors, such as emergency braking, can result in problems in the holding operation. In applications in which safety is a concern, such as for a load falling on a vertical axis, determine if safety measures are required on the machine, such as adding a redundant fall-prevention mechanism.
- For a Servomotor with a Holding Brake, there is a small amount of rotational play in the motor shaft (1.5° max. initially) because of the backlash in the holding brake, even when the brake power is OFF.
- For a Servomotor with a Holding Brake, the brake's rotating disc may sometimes generate murmur from friction during acceleration, stopping, and low-speed operation.

9.2 Coupling to the Machine

You can couple the Servomotor to the machine with either a coupling or a belt. Use the following procedures.

9.2.1 Using a Coupling



Important

- Use a flexible coupling that is designed for Servomotors. We recommend that you use a double-spring coupling, which provides some tolerance in eccentricity and deflection.
- Select a suitable size of coupling for the operating conditions. An inappropriate coupling may cause damage.

1. Wipe off all of the anticorrosive coating from the motor shaft.
2. If you are using a Servomotor with a Key, attach the key enclosed with the Servomotor or the specified size of key to the shaft.



Important

When you attach the key to the motor shaft, do not subject the key groove or shaft to direct shock.

3. Confirm that the centering accuracy is within the specified range using a dial gauge or other means.

If a dial gauge is not available, slide the coupling along both shafts and make adjustments so that it does not catch.

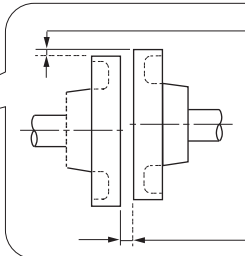
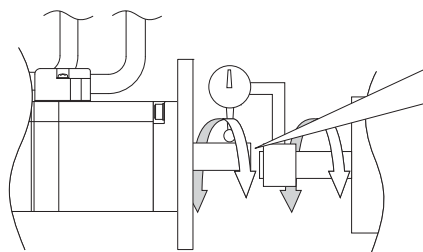

- Centering Accuracy

Measure this distance at four different positions on the circumference. The difference between the maximum and minimum measurements must be 0.03 mm or less. Even within this range, make adjustments to increase centering accuracy as much as possible.

Note: When making the measurements, turn the coupling and motor shaft together.

- Align the shaft of the Servomotor with the shaft of the machine, and then connect the shafts with the coupling.



Important

- When you couple the shafts, make sure that the required centering accuracy is achieved. Vibration will damage the bearings and encoders if the shafts are not properly centered.
- When you attach the coupling, do not subject the shaft to direct shock. Also, do not subject the area around the encoder to shock. Shock may damage the encoder.

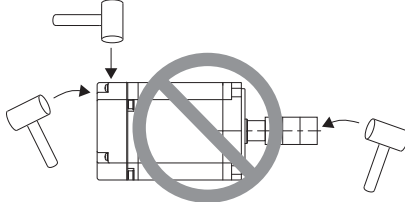

- If the coupling makes any abnormal noise, center the shafts again until the noise is eliminated.
- Make sure that the thrust load and radial load are within specifications. Refer to the specifications for each type of Servomotor for the thrust load and radial load.

9.2.2 Using a Belt



Note

Select a coupling belt that is suitable for the allowable radial load of the Servomotor and the Servomotor output. When the Servomotor accelerates or decelerates, the counterforce from the acceleration/deceleration torque adds tension to the initial belt tension. Take this additional tension into consideration when you select the coupling belt.

- Wipe off all of the anticorrosive coating from the motor shaft.
- If you are using a Servomotor with a Key, attach the key enclosed with the Servomotor or the specified size of key to the shaft.



Important

When you attach the key to the motor shaft, do not subject the key groove or shaft to direct shock.

- If you need to attach a pulley to the Servomotor with a Key, use a screwdriver to tighten the screw in the end of the motor shaft to press in and attach the pulley.

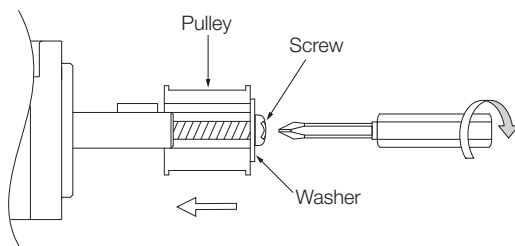

4. Couple the Servomotor to the machine with a belt.

When you attach the belt, adjust the belt tension so that the allowable radial load given in the Servomotor specifications is not exceeded. For details, refer to the catalog of the belt manufacturer.

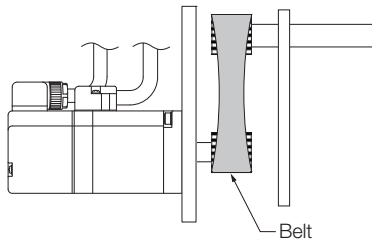

Important

Adjust the belt tension to adjust the radial load. Measure the belt tension at 45° intervals of the machine shaft. Turn the shaft and take measurements with a belt tension meter at each point.

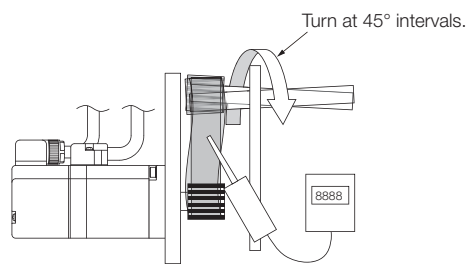

9.3 Oil and Water Countermeasures

Observe the following instructions so that water, oil, or other foreign matter will not enter the Servomotor.

- Do not allow the cables to be in oil or water.

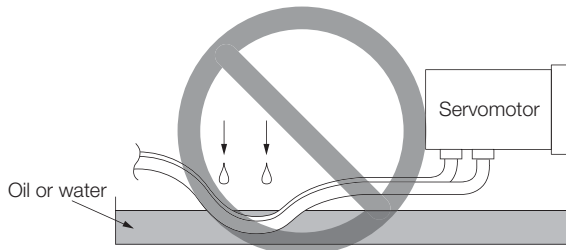

If contact with oil or water is unavoidable, use oil-resistant cables. Oil-resistant cables are not provided by Yaskawa.

- If you install the Servomotor with the end of the shaft facing up, do not use the Servomotor where oil or water from the machine, a gear box, or other source would come into contact with the Servomotor.

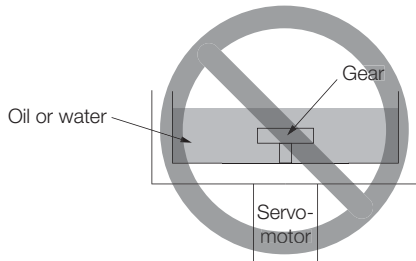

If contact with oil or water is unavoidable, implement countermeasures in the machine so that oil or water from the gear box does not enter the Servomotor.

- Do not use the Servomotor where it would come into contact with cutting fluids. Depending on the type of cutting fluid, sealing materials, packing, cables, or other parts may be adversely affected.
- Do not use the Servomotor where it would be continuously in contact with oil mist, water vapor, oil, water, or grease. If usage under the above conditions is unavoidable, implement countermeasures in the machine to protect against dirt and water.

9.4

Servomotor Temperature Increase

This section describes measures to suppress temperature increases in the Servomotor.

- When you install the Servomotor, observe the cooling conditions (heat sink sizes) that are given in the specifications for each type of Servomotor.
The Servomotor generates heat when it operates. The heat generated by the Servomotor radiates to the heat sink through the motor mounting surface. Therefore, if the surface area of the heat sink is too small, the temperature of the Servomotor may increase abnormally.
- If the operating environment makes it difficult to use a large heat sink, or if the surrounding air temperature or altitude given in the specifications is exceeded, implement the following measures.
 - Derate the Servomotor.
Refer to the specifications for each type of Servomotor for information on derating. Consider derating when you select the capacity of the Servomotor.
 - Use external forced-air cooling for the Servomotor with a cooling fan or other means.



Important

Do not place packing or any other insulating material between the Servomotor and heat sink. Doing so will cause the motor temperature to increase, affect resistance to noise, and may cause motor failure.

Connections between Servomotors and SERVOPACKs

10

This chapter describes the cables that are used to connect the Servomotors and SERVOPACKs and provides related precautions.

10.1	Cables for the SGM7M Servomotors	10-3
10.1.1	Cable Configurations	10-3
10.1.2	Servomotor Main Circuit Cables	10-4
10.1.3	Encoder Cables	10-4
10.2	Cables for the SGM7J Servomotors	10-5
10.2.1	System Configurations	10-5
10.2.2	Servomotor Main Circuit Cables	10-6
10.2.3	Encoder Cables of 20 m or Less	10-9
10.2.4	Relay Encoder Cable of 30 m to 50 m	10-9
10.3	Cables for the SGM7A Servomotors	10-10
10.3.1	Cable Configurations	10-10
10.3.2	Servomotor Main Circuit Cables	10-11
10.3.3	Encoder Cables of 20 m or Less	10-16
10.3.4	Relay Encoder Cable of 30 m to 50 m	10-17
10.4	Cables for the SGM7P Servomotors	10-18
10.4.1	System Configurations	10-18
10.4.2	Servomotor Main Circuit Cables	10-19
10.4.3	Encoder Cables of 20 m or Less	10-21
10.4.4	Relay Encoder Cables of 30 m to 50 m	10-21
10.5	Cables for the SGM7G Servomotors	10-22
10.5.1	System Configurations	10-22
10.5.2	Servomotor Main Circuit Cables	10-23
10.5.3	Encoder Cables of 20 m or Less	10-30
10.5.4	Relay Encoder Cables of 30 m to 50 m	10-30

10.6 Cables for the SGMMV Servomotors . . . 10-31

- 10.6.1 System Configurations 10-31
- 10.6.2 Servomotor Main Circuit Cables 10-32
- 10.6.3 Encoder Cables of 20 m or Less 10-32
- 10.6.4 Relay Encoder Cables of 30 m to 50 m 10-33

10.7 Wiring Servomotors and SERVOPACKs . 10-34

- 10.7.1 Wiring Precautions 10-34
- 10.7.2 Wiring Procedure 10-37

10.1 Cables for the SGM7M Servomotors

10.1.1 Cable Configurations

The cables shown below are required to connect a Servomotor to a SERVOPACK.

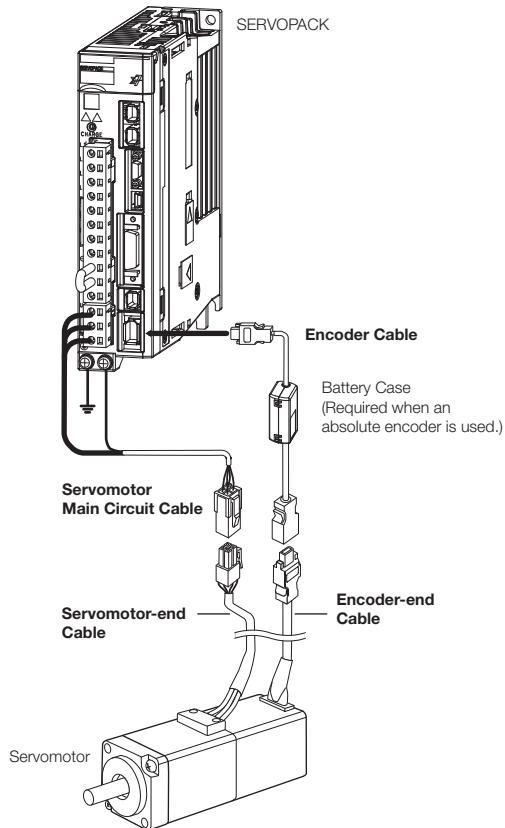

Note: Refer to the following manual for the following information.

- Cable dimensional drawings and cable connection specifications
- Order numbers and specifications of individual connectors for cables
- Order numbers and specifications for wiring materials

📖 *Σ-7-Series Peripheral Device Selection Manual* (Manual No.: SIEP S80001 32)

10.1.2 Servomotor Main Circuit Cables

This section provides information on selecting a Servomotor Main Circuit Cable. Refer to the following manual for detailed information on Cables and for the wiring materials to make your own cables.

📖 *Σ-7-Series Peripheral Device Selection Manual* (Manual No.: SIEP S800001 32)

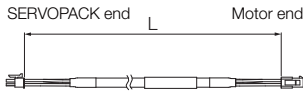
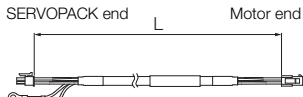
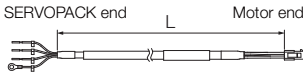
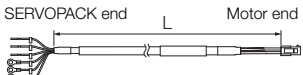
Servomotor Model	Name	Length (L)	Order Number		Appearance
			Standard Cable	Flexible Cable*	
SGM7M-B3E to -B9E 3.3 to 11 W	For Servomotors without Holding Brakes	3 m	JZSP-CF1M00-03-E	JZSP-CF1M20-03-E	
		5 m	JZSP-CF1M00-05-E	JZSP-CF1M20-05-E	
		10 m	JZSP-CF1M00-10-E	JZSP-CF1M20-10-E	
		15 m	JZSP-CF1M00-15-E	JZSP-CF1M20-15-E	
		20 m	JZSP-CF1M00-20-E	JZSP-CF1M20-20-E	
SGM7M-A1E to -A3E 11 to 33 W	For Servomotors with Holding Brakes	3 m	JZSP-CF1M10-03-E	JZSP-CF1M30-03-E	
		5 m	JZSP-CF1M10-05-E	JZSP-CF1M30-05-E	
		10 m	JZSP-CF1M10-10-E	JZSP-CF1M30-10-E	
		15 m	JZSP-CF1M10-15-E	JZSP-CF1M30-15-E	
		20 m	JZSP-CF1M10-20-E	JZSP-CF1M30-20-E	
SGM7M-A1A to -A3A 11 to 33 W	For Servomotors without Holding Brakes	3 m	JZSP-CF2M00-03-E	JZSP-CF2M20-03-E	
		5 m	JZSP-CF2M00-05-E	JZSP-CF2M20-05-E	
		10 m	JZSP-CF2M00-10-E	JZSP-CF2M20-10-E	
		15 m	JZSP-CF2M00-15-E	JZSP-CF2M20-15-E	
	For Servomotors with Holding Brakes	3 m	JZSP-CF2M03-03-E	JZSP-CF2M23-03-E	
		5 m	JZSP-CF2M03-05-E	JZSP-CF2M23-05-E	
		10 m	JZSP-CF2M03-10-E	JZSP-CF2M23-10-E	
		15 m	JZSP-CF2M03-15-E	JZSP-CF2M23-15-E	
20 m	JZSP-CF2M03-20-E	JZSP-CF2M23-20-E			

* Use Flexible Cables for moving parts of machines, such as robots. The recommended bending radius (R) is 90 mm or larger.

10.1.3 Encoder Cables

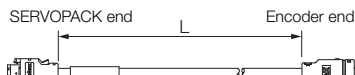
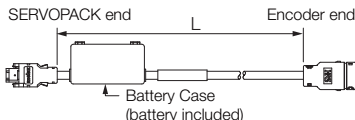
Name	Length (L)	Order Number		Appearance
		Standard Cable	Flexible Cable*	
Cables with Connectors on Both Ends (for incremental encoder)	3 m	JZSP-C7MP01-03-E	JZSP-C7MP21-03-E	
	5 m	JZSP-C7MP01-05-E	JZSP-C7MP21-05-E	
	10 m	JZSP-C7MP01-10-E	JZSP-C7MP21-10-E	
	15 m	JZSP-C7MP01-15-E	JZSP-C7MP21-15-E	
	20 m	JZSP-C7MP01-20-E	JZSP-C7MP21-20-E	
Cables with Connectors on Both Ends (for absolute encoder: With Battery Case)	3 m	JZSP-C7MP19-03-E	JZSP-C7MP29-03-E	
	5 m	JZSP-C7MP19-05-E	JZSP-C7MP29-05-E	
	10 m	JZSP-C7MP19-10-E	JZSP-C7MP29-10-E	
	15 m	JZSP-C7MP19-15-E	JZSP-C7MP29-15-E	
	20 m	JZSP-C7MP19-20-E	JZSP-C7MP29-20-E	

* Use Flexible Cables for moving parts of machines, such as robots. The recommended bending radius (R) is 68 mm or larger.

10.2 Cables for the SGM7J Servomotors

10.2.1 System Configurations

The cables shown below are required to connect a Servomotor to a SERVOPACK.

Encoder Cable of 20 m or Less

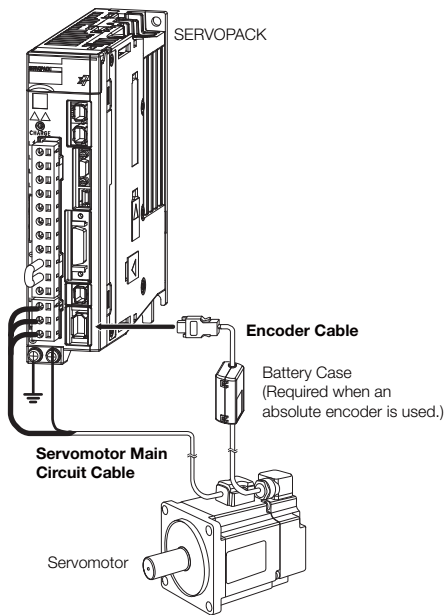

Encoder Cable of 30 m to 50 m (Relay Cable)

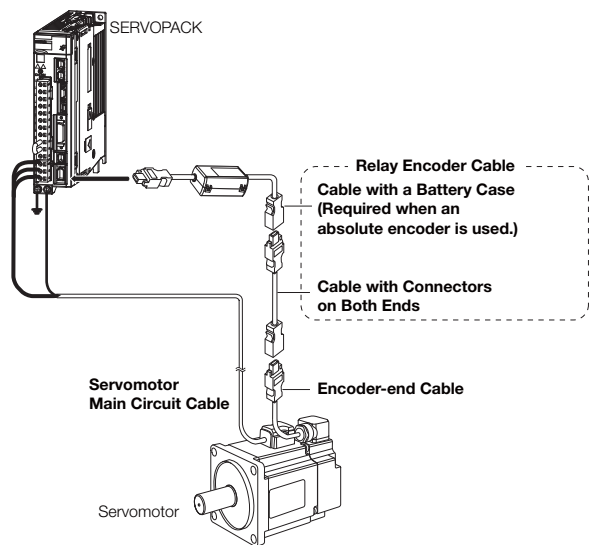

- Note: 1. If the Encoder Cable length exceeds 20 m, be sure to use a Relay Encoder Cable.
 2. If you use a Servomotor Main Circuit Cable that exceeds 20 m, the intermittent duty zone in the torque-motor speed characteristics will become smaller because the voltage drop increases.
 3. Refer to the following manual for the following information.
- Cable dimensional drawings and cable connection specifications
 - Order numbers and specifications of individual connectors for cables
 - Order numbers and specifications for wiring materials
- 📖 Σ-7-Series Peripheral Device Selection Manual (Manual No.: SIEP S800001 32)



Important

There are different order numbers for the Servomotor Main Circuit Cables and Encoder Cables depending on the cable installation direction. Confirm the order numbers before you order.

Cable Installed toward Load

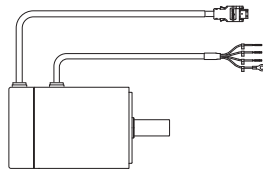

Cable Installed away from Load

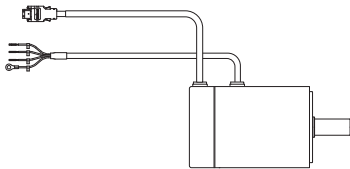

Connections between Servomotors and SERVOPACKS

10.2.2 Servomotor Main Circuit Cables

This section provides information on selecting a Servomotor Main Circuit Cable. Refer to the following manual for detailed information on Cables and for the wiring materials to make your own cables.

☞ Σ -7-Series Peripheral Device Selection Manual (Manual No.: SIEP S800001 32)

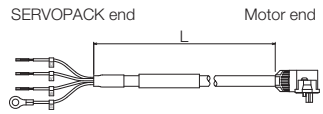
Servomotor Model	Name	Length (L)	Order Number		Appearance
			Standard Cable	Flexible Cable*	
SGM7J-A5 to -C2 50 W to 150 W	For Servo- motors with- out Holding Brakes Cable installed toward load	3 m	JZSP-C7M10F-03-E	JZSP-C7M12F-03-E	
		5 m	JZSP-C7M10F-05-E	JZSP-C7M12F-05-E	
		10 m	JZSP-C7M10F-10-E	JZSP-C7M12F-10-E	
		15 m	JZSP-C7M10F-15-E	JZSP-C7M12F-15-E	
		20 m	JZSP-C7M10F-20-E	JZSP-C7M12F-20-E	
		30 m	JZSP-C7M10F-30-E	JZSP-C7M12F-30-E	
		40 m	JZSP-C7M10F-40-E	JZSP-C7M12F-40-E	
50 m		JZSP-C7M10F-50-E	JZSP-C7M12F-50-E		
SGM7J-02 to -06 200 W to 600 W		3 m	JZSP-C7M20F-03-E	JZSP-C7M22F-03-E	
		5 m	JZSP-C7M20F-05-E	JZSP-C7M22F-05-E	
		10 m	JZSP-C7M20F-10-E	JZSP-C7M22F-10-E	
		15 m	JZSP-C7M20F-15-E	JZSP-C7M22F-15-E	
		20 m	JZSP-C7M20F-20-E	JZSP-C7M22F-20-E	
		30 m	JZSP-C7M20F-30-E	JZSP-C7M22F-30-E	
	40 m	JZSP-C7M20F-40-E	JZSP-C7M22F-40-E		
SGM7J-08 750 W, 1.0 kW	3 m	JZSP-C7M30F-03-E	JZSP-C7M32F-03-E		
	5 m	JZSP-C7M30F-05-E	JZSP-C7M32F-05-E		
	10 m	JZSP-C7M30F-10-E	JZSP-C7M32F-10-E		
	15 m	JZSP-C7M30F-15-E	JZSP-C7M32F-15-E		
	20 m	JZSP-C7M30F-20-E	JZSP-C7M32F-20-E		
	30 m	JZSP-C7M30F-30-E	JZSP-C7M32F-30-E		
	40 m	JZSP-C7M30F-40-E	JZSP-C7M32F-40-E		
50 m	JZSP-C7M30F-50-E	JZSP-C7M32F-50-E			

Continued on next page.

* Use Flexible Cables for moving parts of machines, such as robots. The recommended bending radius (R) is 90 mm or larger.

Continued from previous page.

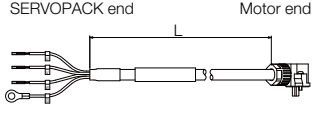
Servomotor Model	Name	Length (L)	Order Number		Appearance
			Standard Cable	Flexible Cable*	
SGM7J-A5 to -C2 50 W to 150 W		3 m	JZSP-C7M10G-03-E	JZSP-C7M12G-03-E	
		5 m	JZSP-C7M10G-05-E	JZSP-C7M12G-05-E	
		10 m	JZSP-C7M10G-10-E	JZSP-C7M12G-10-E	
		15 m	JZSP-C7M10G-15-E	JZSP-C7M12G-15-E	
		20 m	JZSP-C7M10G-20-E	JZSP-C7M12G-20-E	
		30 m	JZSP-C7M10G-30-E	JZSP-C7M12G-30-E	
		40 m	JZSP-C7M10G-40-E	JZSP-C7M12G-40-E	
SGM7J-02 to -06 200 W to 600 W	For Servo- motors with- out Holding Brakes	3 m	JZSP-C7M20G-03-E	JZSP-C7M22G-03-E	
		5 m	JZSP-C7M20G-05-E	JZSP-C7M22G-05-E	
		10 m	JZSP-C7M20G-10-E	JZSP-C7M22G-10-E	
		15 m	JZSP-C7M20G-15-E	JZSP-C7M22G-15-E	
		20 m	JZSP-C7M20G-20-E	JZSP-C7M22G-20-E	
		30 m	JZSP-C7M20G-30-E	JZSP-C7M22G-30-E	
		40 m	JZSP-C7M20G-40-E	JZSP-C7M22G-40-E	
SGM7J-08 750 W, 1.0 kW	Cable installed away from load	5 m	JZSP-C7M20G-50-E	JZSP-C7M22G-50-E	
		3 m	JZSP-C7M30G-03-E	JZSP-C7M32G-03-E	
		5 m	JZSP-C7M30G-05-E	JZSP-C7M32G-05-E	
		10 m	JZSP-C7M30G-10-E	JZSP-C7M32G-10-E	
		15 m	JZSP-C7M30G-15-E	JZSP-C7M32G-15-E	
		20 m	JZSP-C7M30G-20-E	JZSP-C7M32G-20-E	
		30 m	JZSP-C7M30G-30-E	JZSP-C7M32G-30-E	
SGM7J-A5 to -C2 50 W to 150 W		40 m	JZSP-C7M30G-40-E	JZSP-C7M32G-40-E	
		50 m	JZSP-C7M30G-50-E	JZSP-C7M32G-50-E	
		3 m	JZSP-C7M13F-03-E	JZSP-C7M14F-03-E	
		5 m	JZSP-C7M13F-05-E	JZSP-C7M14F-05-E	
		10 m	JZSP-C7M13F-10-E	JZSP-C7M14F-10-E	
		15 m	JZSP-C7M13F-15-E	JZSP-C7M14F-15-E	
		20 m	JZSP-C7M13F-20-E	JZSP-C7M14F-20-E	
SGM7J-02 to -06 200 W to 600 W	For Servo- motors with Holding Brakes	30 m	JZSP-C7M13F-30-E	JZSP-C7M14F-30-E	
		40 m	JZSP-C7M13F-40-E	JZSP-C7M14F-40-E	
		50 m	JZSP-C7M13F-50-E	JZSP-C7M14F-50-E	
		3 m	JZSP-C7M23F-03-E	JZSP-C7M24F-03-E	
		5 m	JZSP-C7M23F-05-E	JZSP-C7M24F-05-E	
		10 m	JZSP-C7M23F-10-E	JZSP-C7M24F-10-E	
		15 m	JZSP-C7M23F-15-E	JZSP-C7M24F-15-E	
SGM7J-08 750 W, 1.0 kW	Cable installed toward load	20 m	JZSP-C7M23F-20-E	JZSP-C7M24F-20-E	
		30 m	JZSP-C7M23F-30-E	JZSP-C7M24F-30-E	
		40 m	JZSP-C7M23F-40-E	JZSP-C7M24F-40-E	
		50 m	JZSP-C7M23F-50-E	JZSP-C7M24F-50-E	
		3 m	JZSP-C7M33F-03-E	JZSP-C7M34F-03-E	
		5 m	JZSP-C7M33F-05-E	JZSP-C7M34F-05-E	
		10 m	JZSP-C7M33F-10-E	JZSP-C7M34F-10-E	
SGM7J-08 750 W, 1.0 kW		15 m	JZSP-C7M33F-15-E	JZSP-C7M34F-15-E	
		20 m	JZSP-C7M33F-20-E	JZSP-C7M34F-20-E	
		30 m	JZSP-C7M33F-30-E	JZSP-C7M34F-30-E	
		40 m	JZSP-C7M33F-40-E	JZSP-C7M34F-40-E	
		50 m	JZSP-C7M33F-50-E	JZSP-C7M34F-50-E	

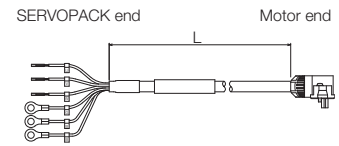
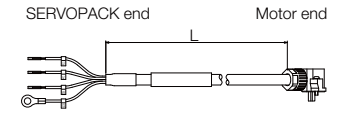

Continued on next page.

* Use Flexible Cables for moving parts of machines, such as robots. The recommended bending radius (R) is 90 mm or larger.

10.2 Cables for the SGM7J Servomotors

10.2.2 Servomotor Main Circuit Cables

Continued from previous page.

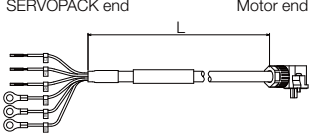
Servomotor Model	Name	Length (L)	Order Number		Appearance
			Standard Cable	Flexible Cable*	
SGM7J-A5 to -C2 50 W to 150 W		3 m	JZSP-C7M13G-03-E	JZSP-C7M14G-03-E	
		5 m	JZSP-C7M13G-05-E	JZSP-C7M14G-05-E	
		10 m	JZSP-C7M13G-10-E	JZSP-C7M14G-10-E	
		15 m	JZSP-C7M13G-15-E	JZSP-C7M14G-15-E	
		20 m	JZSP-C7M13G-20-E	JZSP-C7M14G-20-E	
		30 m	JZSP-C7M13G-30-E	JZSP-C7M14G-30-E	
		40 m	JZSP-C7M13G-40-E	JZSP-C7M14G-40-E	
		50 m	JZSP-C7M13G-50-E	JZSP-C7M14G-50-E	
SGM7J-02 to -06 200 W to 600 W	For Servo- motors with Holding Brakes Cable installed away from load	3 m	JZSP-C7M23G-03-E	JZSP-C7M24G-03-E	
		5 m	JZSP-C7M23G-05-E	JZSP-C7M24G-05-E	
		10 m	JZSP-C7M23G-10-E	JZSP-C7M24G-10-E	
		15 m	JZSP-C7M23G-15-E	JZSP-C7M24G-15-E	
		20 m	JZSP-C7M23G-20-E	JZSP-C7M24G-20-E	
		30 m	JZSP-C7M23G-30-E	JZSP-C7M24G-30-E	
		40 m	JZSP-C7M23G-40-E	JZSP-C7M24G-40-E	
		50 m	JZSP-C7M23G-50-E	JZSP-C7M24G-50-E	
SGM7J-08 750 W, 1.0 kW		3 m	JZSP-C7M33G-03-E	JZSP-C7M34G-03-E	
		5 m	JZSP-C7M33G-05-E	JZSP-C7M34G-05-E	
		10 m	JZSP-C7M33G-10-E	JZSP-C7M34G-10-E	
		15 m	JZSP-C7M33G-15-E	JZSP-C7M34G-15-E	
		20 m	JZSP-C7M33G-20-E	JZSP-C7M34G-20-E	
		30 m	JZSP-C7M33G-30-E	JZSP-C7M34G-30-E	
		40 m	JZSP-C7M33G-40-E	JZSP-C7M34G-40-E	
		50 m	JZSP-C7M33G-50-E	JZSP-C7M34G-50-E	

* Use Flexible Cables for moving parts of machines, such as robots. The recommended bending radius (R) is 90 mm or larger.

10.2.3 Encoder Cables of 20 m or Less

Servomotor Model	Name	Length (L)	Order Number		Appearance
			Standard Cable	Flexible Cable*1	
All SGM7J models	For incremental encoder or for batteryless absolute encoder Cable installed toward load	3 m	JZSP-C7PI0D-03-E	JZSP-C7PI2D-03-E	
		5 m	JZSP-C7PI0D-05-E	JZSP-C7PI2D-05-E	
		10 m	JZSP-C7PI0D-10-E	JZSP-C7PI2D-10-E	
		15 m	JZSP-C7PI0D-15-E	JZSP-C7PI2D-15-E	
		20 m	JZSP-C7PI0D-20-E	JZSP-C7PI2D-20-E	
	For incremental encoder or for batteryless absolute encoder Cable installed away from load	3 m	JZSP-C7PI0E-03-E	JZSP-C7PI2E-03-E	
		5 m	JZSP-C7PI0E-05-E	JZSP-C7PI2E-05-E	
		10 m	JZSP-C7PI0E-10-E	JZSP-C7PI2E-10-E	
		15 m	JZSP-C7PI0E-15-E	JZSP-C7PI2E-15-E	
		20 m	JZSP-C7PI0E-20-E	JZSP-C7PI2E-20-E	
	For absolute encoder: With Battery Case*2 Cable installed toward load	3 m	JZSP-C7PA0D-03-E	JZSP-C7PA2D-03-E	
		5 m	JZSP-C7PA0D-05-E	JZSP-C7PA2D-05-E	
		10 m	JZSP-C7PA0D-10-E	JZSP-C7PA2D-10-E	
		15 m	JZSP-C7PA0D-15-E	JZSP-C7PA2D-15-E	
		20 m	JZSP-C7PA0D-20-E	JZSP-C7PA2D-20-E	
	For absolute encoder: With Battery Case*2 Cable installed away from load	3 m	JZSP-C7PA0E-03-E	JZSP-C7PA2E-03-E	
		5 m	JZSP-C7PA0E-05-E	JZSP-C7PA2E-05-E	
		10 m	JZSP-C7PA0E-10-E	JZSP-C7PA2E-10-E	
		15 m	JZSP-C7PA0E-15-E	JZSP-C7PA2E-15-E	
		20 m	JZSP-C7PA0E-20-E	JZSP-C7PA2E-20-E	

*1. Use Flexible Cables for moving parts of machines, such as robots. The recommended bending radius (R) is 90 mm or larger.

*2. If a battery is connected to the host controller, the Battery Case is not required.

10.2.4 Relay Encoder Cable of 30 m to 50 m

Servomotor Model	Name	Length (L)	Order Number	Appearance
All SGM7J models	Encoder-end Cable (for all types of encoders) Cable installed toward load	0.3 m	JZSP-C7PRCD-E	
	Encoder-end Cable (for all types of encoders) Cable installed away from load	0.3 m	JZSP-C7PRCE-E	
	Cable with Connectors on Both Ends (for all types of encoders)	30 m	JZSP-UCMP00-30-E	
		40 m	JZSP-UCMP00-40-E	
		50 m	JZSP-UCMP00-50-E	
Cable with a Battery Case (Required when an absolute encoder is used.*)	0.3 m	JZSP-CSP12-E		

* This Cable is not required if you use a Servomotor with a Batteryless Absolute Encoder, and you connect a battery to the host controller.

10.3 Cables for the SGM7A Servomotors

10.3.1 Cable Configurations

The cables shown below are required to connect a Servomotor to a SERVOPACK.

Encoder Cable of 20 m or Less

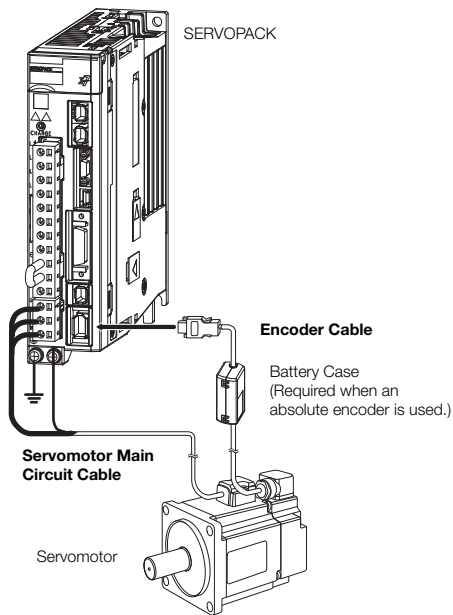

Encoder Cable of 30 m to 50 m (Relay Cable)

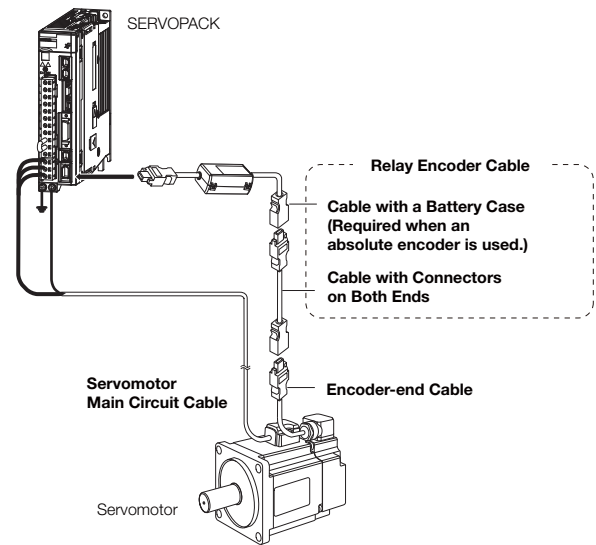

- Note: 1. Cables with connectors on both ends that are compliant with an IP67 protective structure and European Safety Standards are not available from Yaskawa for the SGM7A-15A to SGM7A-70A Servomotors. You must make such a cable yourself. Use the Connectors specified by Yaskawa for these Servomotors. (These Connectors are compliant with the standards.) Yaskawa does not specify what wiring materials to use.
2. If the Encoder Cable length exceeds 20 m, be sure to use a Relay Encoder Cable.
3. If you use a Servomotor Main Circuit Cable that exceeds 20 m, the intermittent duty zone in the torque-motor speed characteristics will become smaller because the voltage drop increases.
4. Refer to the following manual for the following information.
- Cable dimensional drawings and cable connection specifications
 - Order numbers and specifications of individual connectors for cables
 - Order numbers and specifications for wiring materials
- Σ-7-Series AC Servo Drive Peripheral Device Selection Manual (Manual No.: SIEP S800001 32)*



Important

For the SGM7A-A5 to -10, there are different order numbers for the Servomotor Main Circuit Cables and Encoder Cables depending on the cable installation direction. Confirm the order numbers before you order.

Cable Installed toward Load

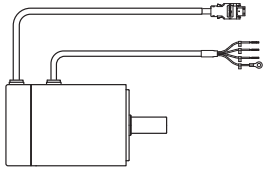

Cable Installed away from Load

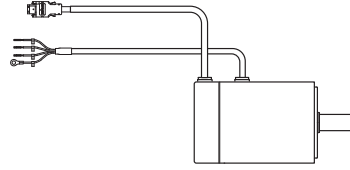

10.3.2 Servomotor Main Circuit Cables

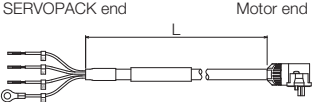
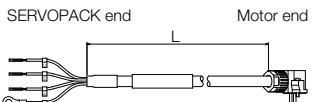
Servomotor Model	Name	Length (L)	Order Number		Appearance
			Standard Cable	Flexible Cable*	
SGM7A-A5 to -C2 50 W to 150 W		3 m	JZSP-C7M10F-03-E	JZSP-C7M12F-03-E	
		5 m	JZSP-C7M10F-05-E	JZSP-C7M12F-05-E	
		10 m	JZSP-C7M10F-10-E	JZSP-C7M12F-10-E	
		15 m	JZSP-C7M10F-15-E	JZSP-C7M12F-15-E	
		20 m	JZSP-C7M10F-20-E	JZSP-C7M12F-20-E	
		30 m	JZSP-C7M10F-30-E	JZSP-C7M12F-30-E	
		40 m	JZSP-C7M10F-40-E	JZSP-C7M12F-40-E	
		50 m	JZSP-C7M10F-50-E	JZSP-C7M12F-50-E	
SGM7A-02 to -06 200 W to 600 W	For Servo- motors with- out Holding Brakes Cable installed toward load	3 m	JZSP-C7M20F-03-E	JZSP-C7M22F-03-E	
		5 m	JZSP-C7M20F-05-E	JZSP-C7M22F-05-E	
		10 m	JZSP-C7M20F-10-E	JZSP-C7M22F-10-E	
		15 m	JZSP-C7M20F-15-E	JZSP-C7M22F-15-E	
		20 m	JZSP-C7M20F-20-E	JZSP-C7M22F-20-E	
		30 m	JZSP-C7M20F-30-E	JZSP-C7M22F-30-E	
		40 m	JZSP-C7M20F-40-E	JZSP-C7M22F-40-E	
		50 m	JZSP-C7M20F-50-E	JZSP-C7M22F-50-E	
SGM7A-08 and -10 750 W, 1.0 kW		3 m	JZSP-C7M30F-03-E	JZSP-C7M32F-03-E	
		5 m	JZSP-C7M30F-05-E	JZSP-C7M32F-05-E	
		10 m	JZSP-C7M30F-10-E	JZSP-C7M32F-10-E	
		15 m	JZSP-C7M30F-15-E	JZSP-C7M32F-15-E	
		20 m	JZSP-C7M30F-20-E	JZSP-C7M32F-20-E	
		30 m	JZSP-C7M30F-30-E	JZSP-C7M32F-30-E	
		40 m	JZSP-C7M30F-40-E	JZSP-C7M32F-40-E	
		50 m	JZSP-C7M30F-50-E	JZSP-C7M32F-50-E	
SGM7A-A5 to -C2 50 W to 150 W		3 m	JZSP-C7M10G-03-E	JZSP-C7M12G-03-E	
		5 m	JZSP-C7M10G-05-E	JZSP-C7M12G-05-E	
		10 m	JZSP-C7M10G-10-E	JZSP-C7M12G-10-E	
		15 m	JZSP-C7M10G-15-E	JZSP-C7M12G-15-E	
		20 m	JZSP-C7M10G-20-E	JZSP-C7M12G-20-E	
		30 m	JZSP-C7M10G-30-E	JZSP-C7M12G-30-E	
		40 m	JZSP-C7M10G-40-E	JZSP-C7M12G-40-E	
		50 m	JZSP-C7M10G-50-E	JZSP-C7M12G-50-E	
SGM7A-02 to -06 200 W to 600 W	For Servo- motors with- out Holding Brakes Cable installed away from load	3 m	JZSP-C7M20G-03-E	JZSP-C7M22G-03-E	
		5 m	JZSP-C7M20G-05-E	JZSP-C7M22G-05-E	
		10 m	JZSP-C7M20G-10-E	JZSP-C7M22G-10-E	
		15 m	JZSP-C7M20G-15-E	JZSP-C7M22G-15-E	
		20 m	JZSP-C7M20G-20-E	JZSP-C7M22G-20-E	
		30 m	JZSP-C7M20G-30-E	JZSP-C7M22G-30-E	
		40 m	JZSP-C7M20G-40-E	JZSP-C7M22G-40-E	
		50 m	JZSP-C7M20G-50-E	JZSP-C7M22G-50-E	
SGM7A-08 and -10 750 W, 1.0 kW		3 m	JZSP-C7M30G-03-E	JZSP-C7M32G-03-E	
		5 m	JZSP-C7M30G-05-E	JZSP-C7M32G-05-E	
		10 m	JZSP-C7M30G-10-E	JZSP-C7M32G-10-E	
		15 m	JZSP-C7M30G-15-E	JZSP-C7M32G-15-E	
		20 m	JZSP-C7M30G-20-E	JZSP-C7M32G-20-E	
		30 m	JZSP-C7M30G-30-E	JZSP-C7M32G-30-E	
		40 m	JZSP-C7M30G-40-E	JZSP-C7M32G-40-E	
		50 m	JZSP-C7M30G-50-E	JZSP-C7M32G-50-E	



* Use Flexible Cables for moving parts of machines, such as robots. The recommended bending radius (R) is 90 mm or larger.

10.3 Cables for the SGM7A Servomotors

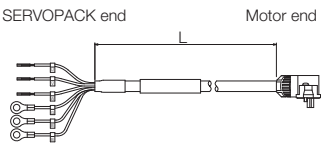
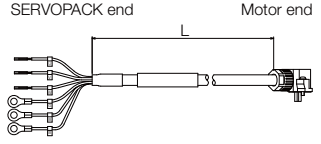
10.3.2 Servomotor Main Circuit Cables

Servomotor Model	Name	Length (L)	Order Number		Appearance
			Standard Cable	Flexible Cable*	
SGM7A-A5 to -C2 50 W to 150 W	For Servo- motors with Holding Brakes Cable installed toward load	3 m	JZSP-C7M13F-03-E	JZSP-C7M14F-03-E	
		5 m	JZSP-C7M13F-05-E	JZSP-C7M14F-05-E	
		10 m	JZSP-C7M13F-10-E	JZSP-C7M14F-10-E	
		15 m	JZSP-C7M13F-15-E	JZSP-C7M14F-15-E	
		20 m	JZSP-C7M13F-20-E	JZSP-C7M14F-20-E	
		30 m	JZSP-C7M13F-30-E	JZSP-C7M14F-30-E	
		40 m	JZSP-C7M13F-40-E	JZSP-C7M14F-40-E	
50 m		JZSP-C7M13F-50-E	JZSP-C7M14F-50-E		
SGM7A-02 to -06 200 W to 600 W		3 m	JZSP-C7M23F-03-E	JZSP-C7M24F-03-E	
		5 m	JZSP-C7M23F-05-E	JZSP-C7M24F-05-E	
		10 m	JZSP-C7M23F-10-E	JZSP-C7M24F-10-E	
		15 m	JZSP-C7M23F-15-E	JZSP-C7M24F-15-E	
		20 m	JZSP-C7M23F-20-E	JZSP-C7M24F-20-E	
		30 m	JZSP-C7M23F-30-E	JZSP-C7M24F-30-E	
	40 m	JZSP-C7M23F-40-E	JZSP-C7M24F-40-E		
SGM7A-08 and -10 750 W, 1.0 kW	3 m	JZSP-C7M33F-03-E	JZSP-C7M34F-03-E		
	5 m	JZSP-C7M33F-05-E	JZSP-C7M34F-05-E		
	10 m	JZSP-C7M33F-10-E	JZSP-C7M34F-10-E		
	15 m	JZSP-C7M33F-15-E	JZSP-C7M34F-15-E		
	20 m	JZSP-C7M33F-20-E	JZSP-C7M34F-20-E		
	30 m	JZSP-C7M33F-30-E	JZSP-C7M34F-30-E		
	40 m	JZSP-C7M33F-40-E	JZSP-C7M34F-40-E		
SGM7A-A5 to -C2 50 W to 150 W	For Servo- motors with Holding Brakes Cable installed away from load	3 m	JZSP-C7M13G-03-E	JZSP-C7M14G-03-E	
		5 m	JZSP-C7M13G-05-E	JZSP-C7M14G-05-E	
		10 m	JZSP-C7M13G-10-E	JZSP-C7M14G-10-E	
		15 m	JZSP-C7M13G-15-E	JZSP-C7M14G-15-E	
		20 m	JZSP-C7M13G-20-E	JZSP-C7M14G-20-E	
		30 m	JZSP-C7M13G-30-E	JZSP-C7M14G-30-E	
		40 m	JZSP-C7M13G-40-E	JZSP-C7M14G-40-E	
50 m		JZSP-C7M13G-50-E	JZSP-C7M14G-50-E		
SGM7A-02 to -06 200 W to 600 W		3 m	JZSP-C7M23G-03-E	JZSP-C7M24G-03-E	
		5 m	JZSP-C7M23G-05-E	JZSP-C7M24G-05-E	
		10 m	JZSP-C7M23G-10-E	JZSP-C7M24G-10-E	
		15 m	JZSP-C7M23G-15-E	JZSP-C7M24G-15-E	
		20 m	JZSP-C7M23G-20-E	JZSP-C7M24G-20-E	
		30 m	JZSP-C7M23G-30-E	JZSP-C7M24G-30-E	
	40 m	JZSP-C7M23G-40-E	JZSP-C7M24G-40-E		
SGM7A-08 and -10 750 W, 1.0 kW	3 m	JZSP-C7M33G-03-E	JZSP-C7M34G-03-E		
	5 m	JZSP-C7M33G-05-E	JZSP-C7M34G-05-E		
	10 m	JZSP-C7M33G-10-E	JZSP-C7M34G-10-E		
	15 m	JZSP-C7M33G-15-E	JZSP-C7M34G-15-E		
	20 m	JZSP-C7M33G-20-E	JZSP-C7M34G-20-E		
	30 m	JZSP-C7M33G-30-E	JZSP-C7M34G-30-E		
	40 m	JZSP-C7M33G-40-E	JZSP-C7M34G-40-E		
50 m	JZSP-C7M33G-50-E	JZSP-C7M34G-50-E			

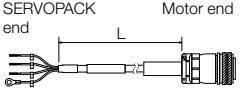
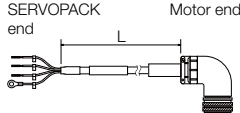
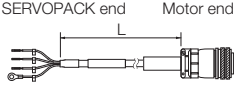
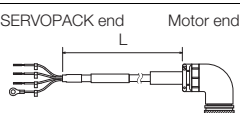
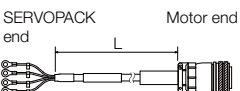
* Use Flexible Cables for moving parts of machines, such as robots. The recommended bending radius (R) is 90 mm or larger.

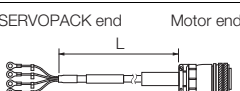
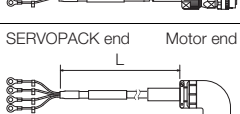
Servo-motor Model	Name	Connector Specifications	Length (L)	Order Number		Appearance
				Standard Cable	Flexible Cable*1	
SGM7A-15 1.5 kW	For Servomotors without Holding Brakes	Straight	3 m	JZSP-UVA101-03-E	JZSP-UVA121-03-E	
			5 m	JZSP-UVA101-05-E	JZSP-UVA121-05-E	
			10 m	JZSP-UVA101-10-E	JZSP-UVA121-10-E	
			15 m	JZSP-UVA101-15-E	JZSP-UVA121-15-E	
			20 m	JZSP-UVA101-20-E	JZSP-UVA121-20-E	
		Right-angle	3 m	JZSP-UVA102-03-E	JZSP-UVA122-03-E	
			5 m	JZSP-UVA102-05-E	JZSP-UVA122-05-E	
			10 m	JZSP-UVA102-10-E	JZSP-UVA122-10-E	
			15 m	JZSP-UVA102-15-E	JZSP-UVA122-15-E	
			20 m	JZSP-UVA102-20-E	JZSP-UVA122-20-E	
	For Servomotors with Holding Brakes (Set of Two Cables*2)	Straight	3 m	JZSP-UVA131-03-E	JZSP-UVA141-03-E	
			5 m	JZSP-UVA131-05-E	JZSP-UVA141-05-E	
			10 m	JZSP-UVA131-10-E	JZSP-UVA141-10-E	
			15 m	JZSP-UVA131-15-E	JZSP-UVA141-15-E	
			20 m	JZSP-UVA131-20-E	JZSP-UVA141-20-E	
Right-angle		3 m	JZSP-UVA132-03-E	JZSP-UVA142-03-E		
		5 m	JZSP-UVA132-05-E	JZSP-UVA142-05-E		
		10 m	JZSP-UVA132-10-E	JZSP-UVA142-10-E		
		15 m	JZSP-UVA132-15-E	JZSP-UVA142-15-E		
		20 m	JZSP-UVA132-20-E	JZSP-UVA142-20-E		
SGM7A-20 2.0 kW	For Servomotors without Holding Brakes	Straight	3 m	JZSP-UVA301-03-E	JZSP-UVA321-03-E	
			5 m	JZSP-UVA301-05-E	JZSP-UVA321-05-E	
			10 m	JZSP-UVA301-10-E	JZSP-UVA321-10-E	
			15 m	JZSP-UVA301-15-E	JZSP-UVA321-15-E	
			20 m	JZSP-UVA301-20-E	JZSP-UVA321-20-E	
		Right-angle	3 m	JZSP-UVA302-03-E	JZSP-UVA322-03-E	
			5 m	JZSP-UVA302-05-E	JZSP-UVA322-05-E	
			10 m	JZSP-UVA302-10-E	JZSP-UVA322-10-E	
			15 m	JZSP-UVA302-15-E	JZSP-UVA322-15-E	
			20 m	JZSP-UVA302-20-E	JZSP-UVA322-20-E	
	For Servomotors with Holding Brakes (Set of Two Cables*2)	Straight	3 m	JZSP-UVA331-03-E	JZSP-UVA341-03-E	
			5 m	JZSP-UVA331-05-E	JZSP-UVA341-05-E	
			10 m	JZSP-UVA331-10-E	JZSP-UVA341-10-E	
			15 m	JZSP-UVA331-15-E	JZSP-UVA341-15-E	
			20 m	JZSP-UVA331-20-E	JZSP-UVA341-20-E	
Right-angle		3 m	JZSP-UVA332-03-E	JZSP-UVA342-03-E		
		5 m	JZSP-UVA332-05-E	JZSP-UVA342-05-E		
		10 m	JZSP-UVA332-10-E	JZSP-UVA342-10-E		
		15 m	JZSP-UVA332-15-E	JZSP-UVA342-15-E		
		20 m	JZSP-UVA332-20-E	JZSP-UVA342-20-E		

*1. Use Flexible Cables for moving parts of machines, such as robots. The recommended bending radius (R) is 90 mm or larger.



*2. This order number is for a set of two cables (Main Power Supply Cable and Holding Brake Cable). When you purchase them separately, the order numbers for Main Power Supply Cables are the same as for a Servomotor without a Holding Brake.

The following order numbers are for a Holding Brake Cable. These Standard Cables are Flexible Cables.

- Cable with Straight Plug: JZSP-U7B23-□□-E
- Cable with Right-angle Plug: JZSP-U7B24-□□-E

10.3 Cables for the SGM7A Servomotors

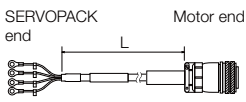
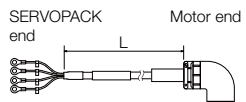
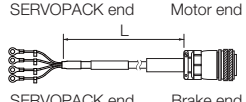
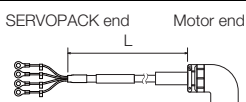
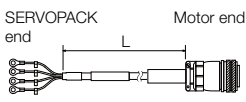
10.3.2 Servomotor Main Circuit Cables

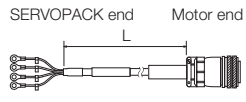
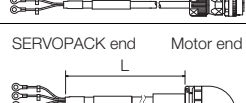
Servo-motor Model	Name	Connector Specifications	Length (L)	Order Number		Appearance
				Standard Cable	Flexible Cable* ¹	
SGM7A-25 2.5 kW	For Servomotors without Holding Brakes	Straight	3 m	JZSP-UVA501-03-E	JZSP-UVA521-03-E	
			5 m	JZSP-UVA501-05-E	JZSP-UVA521-05-E	
			10 m	JZSP-UVA501-10-E	JZSP-UVA521-10-E	
			15 m	JZSP-UVA501-15-E	JZSP-UVA521-15-E	
			20 m	JZSP-UVA501-20-E	JZSP-UVA521-20-E	
		Right-angle	3 m	JZSP-UVA502-03-E	JZSP-UVA522-03-E	
			5 m	JZSP-UVA502-05-E	JZSP-UVA522-05-E	
			20 m	JZSP-UVA502-20-E	JZSP-UVA522-20-E	
	For Servomotors with Holding Brakes (Set of Two Cables* ²)	Straight	3 m	JZSP-U7A551-03-E	JZSP-U7A561-03-E	
			5 m	JZSP-U7A551-05-E	JZSP-U7A561-05-E	
			10 m	JZSP-U7A551-10-E	JZSP-U7A561-10-E	
			15 m	JZSP-U7A551-15-E	JZSP-U7A561-15-E	
			20 m	JZSP-U7A551-20-E	JZSP-U7A561-20-E	
		Right-angle	3 m	JZSP-U7A552-03-E	JZSP-U7A562-03-E	
			5 m	JZSP-U7A552-05-E	JZSP-U7A562-05-E	
			20 m	JZSP-U7A552-20-E	JZSP-U7A562-20-E	
SGM7A-30 3.0 kW	For Servomotors without Holding Brakes	Straight	3 m	JZSP-UVA601-03-E	JZSP-UVA621-03-E	
			5 m	JZSP-UVA601-05-E	JZSP-UVA621-05-E	
			10 m	JZSP-UVA601-10-E	JZSP-UVA621-10-E	
			15 m	JZSP-UVA601-15-E	JZSP-UVA621-15-E	
			20 m	JZSP-UVA601-20-E	JZSP-UVA621-20-E	
		Right-angle	3 m	JZSP-UVA602-03-E	JZSP-UVA622-03-E	
			5 m	JZSP-UVA602-05-E	JZSP-UVA622-05-E	
			20 m	JZSP-UVA602-20-E	JZSP-UVA622-20-E	
	For Servomotors with Holding Brakes (Set of Two Cables* ²)	Straight	3 m	JZSP-UVA631-03-E	JZSP-UVA641-03-E	
			5 m	JZSP-UVA631-05-E	JZSP-UVA641-05-E	
			10 m	JZSP-UVA631-10-E	JZSP-UVA641-10-E	
			15 m	JZSP-UVA631-15-E	JZSP-UVA641-15-E	
			20 m	JZSP-UVA631-20-E	JZSP-UVA641-20-E	
		Right-angle	3 m	JZSP-UVA632-03-E	JZSP-UVA642-03-E	
			5 m	JZSP-UVA632-05-E	JZSP-UVA642-05-E	
			20 m	JZSP-UVA632-20-E	JZSP-UVA642-20-E	

*1. Use Flexible Cables for moving parts of machines, such as robots. The recommended bending radius (R) is 90 mm or larger.

*2. This order number is for a set of two cables (Main Power Supply Cable and Holding Brake Cable). When you purchase them separately, the order numbers for Main Power Supply Cables are the same as for a Servomotor without a Holding Brake.

The following order numbers are for a Holding Brake Cable. These Standard Cables are Flexible Cables.

- Cable with Straight Plug: JZSP-U7B23-□□-E
- Cable with Right-angle Plug: JZSP-U7B24-□□-E

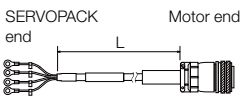
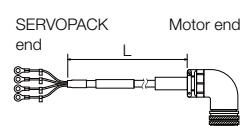
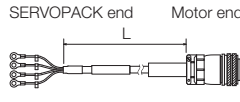
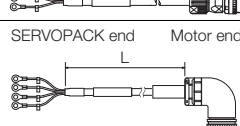
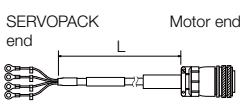
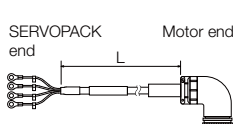
Servo-motor Model	Name	Connector Specifications	Length (L)	Order Number		Appearance
				Standard Cable	Flexible Cable* ¹	
SGM7A-40 and -50 4.0 kW, 5.0 kW	For Servomotors without Holding Brakes	Straight	3 m	JZSP-UVA701-03-E	JZSP-UVA721-03-E	
			5 m	JZSP-UVA701-05-E	JZSP-UVA721-05-E	
			10 m	JZSP-UVA701-10-E	JZSP-UVA721-10-E	
			15 m	JZSP-UVA701-15-E	JZSP-UVA721-15-E	
			20 m	JZSP-UVA701-20-E	JZSP-UVA721-20-E	
		Right-angle	3 m	JZSP-UVA702-03-E	JZSP-UVA722-03-E	
			5 m	JZSP-UVA702-05-E	JZSP-UVA722-05-E	
			10 m	JZSP-UVA702-10-E	JZSP-UVA722-10-E	
			15 m	JZSP-UVA702-15-E	JZSP-UVA722-15-E	
			20 m	JZSP-UVA702-20-E	JZSP-UVA722-20-E	
	For Servomotors with Holding Brakes (Set of Two Cables* ²)	Straight	3 m	JZSP-UVA731-03-E	JZSP-UVA741-03-E	
			5 m	JZSP-UVA731-05-E	JZSP-UVA741-05-E	
			10 m	JZSP-UVA731-10-E	JZSP-UVA741-10-E	
			15 m	JZSP-UVA731-15-E	JZSP-UVA741-15-E	
			20 m	JZSP-UVA731-20-E	JZSP-UVA741-20-E	
Right-angle		3 m	JZSP-UVA732-03-E	JZSP-UVA742-03-E		
		5 m	JZSP-UVA732-05-E	JZSP-UVA742-05-E		
		10 m	JZSP-UVA732-10-E	JZSP-UVA742-10-E		
		15 m	JZSP-UVA732-15-E	JZSP-UVA742-15-E		
		20 m	JZSP-UVA732-20-E	JZSP-UVA742-20-E		
SGM7A-70* ³ 7.0 kW	For Servomotors without Holding Brakes	Straight	3 m	JZSP-UVA901-03-E	JZSP-UVA921-03-E	
			5 m	JZSP-UVA901-05-E	JZSP-UVA921-05-E	
			10 m	JZSP-UVA901-10-E	JZSP-UVA921-10-E	
			15 m	JZSP-UVA901-15-E	JZSP-UVA921-15-E	
			20 m	JZSP-UVA901-20-E	JZSP-UVA921-20-E	
		Right-angle	3 m	JZSP-UVA902-03-E	JZSP-UVA922-03-E	
			5 m	JZSP-UVA902-05-E	JZSP-UVA922-05-E	
			10 m	JZSP-UVA902-10-E	JZSP-UVA922-10-E	
			15 m	JZSP-UVA902-15-E	JZSP-UVA922-15-E	
			20 m	JZSP-UVA902-20-E	JZSP-UVA922-20-E	

*1. Use Flexible Cables for moving parts of machines, such as robots. The recommended bending radius (R) is 90 mm or larger.

*2. This order number is for a set of two cables (Main Power Supply Cable and Holding Brake Cable). When you purchase them separately, the order numbers for Main Power Supply Cables are the same as for a Servomotor without a Holding Brake.

The following order numbers are for a Holding Brake Cable. These Standard Cables are Flexible Cables.

- Cable with Straight Plug: JZSP-U7B23-□□-E
- Cable with Right-angle Plug: JZSP-U7B24-□□-E

*3. A cooling fan is built into the SGM7A-70 Servomotor. There is no specified cable to connect to the built-in cooling fan connector. Use appropriate wiring materials for the built-in cooling fan connector specifications. The cable is available from Yaskawa Controls Co., Ltd. Refer to the following manual for the built-in cooling fan connector specifications that are required to select the cable.

 [Σ-7-Series AC Servo Drive Peripheral Device Selection Manual \(Manual No.: SIEP S80001 32\)](#)

10.3.3 Encoder Cables of 20 m or Less



Servomotor Model	Name	Length (L)	Order Number		Appearance	
			Standard Cable	Flexible Cable* ¹		
SGM7A-A5 to -10 50 W to 1.0 kW	For incremental encoder, or batteryless absolute encoder	3 m	JZSP-C7PI0D-03-E	JZSP-C7PI2D-03-E		
		5 m	JZSP-C7PI0D-05-E	JZSP-C7PI2D-05-E		
		10 m	JZSP-C7PI0D-10-E	JZSP-C7PI2D-10-E		
		15 m	JZSP-C7PI0D-15-E	JZSP-C7PI2D-15-E		
	Cable installed toward load	20 m	JZSP-C7PI0D-20-E	JZSP-C7PI2D-20-E		
		For incremental encoder, or batteryless absolute encoder	3 m	JZSP-C7PI0E-03-E	JZSP-C7PI2E-03-E	
			5 m	JZSP-C7PI0E-05-E	JZSP-C7PI2E-05-E	
			10 m	JZSP-C7PI0E-10-E	JZSP-C7PI2E-10-E	
	15 m		JZSP-C7PI0E-15-E	JZSP-C7PI2E-15-E		
	Cable installed away from load	20 m	JZSP-C7PI0E-20-E	JZSP-C7PI2E-20-E		
		For absolute encoder: With Battery Case* ²	3 m	JZSP-C7PA0D-03-E	JZSP-C7PA2D-03-E	
			5 m	JZSP-C7PA0D-05-E	JZSP-C7PA2D-05-E	
			10 m	JZSP-C7PA0D-10-E	JZSP-C7PA2D-10-E	
	15 m		JZSP-C7PA0D-15-E	JZSP-C7PA2D-15-E		
	Cable installed toward load	20 m	JZSP-C7PA0D-20-E	JZSP-C7PA2D-20-E		
		For absolute encoder: With Battery Case* ²	3 m	JZSP-C7PA0E-03-E	JZSP-C7PA2E-03-E	
5 m			JZSP-C7PA0E-05-E	JZSP-C7PA2E-05-E		
10 m			JZSP-C7PA0E-10-E	JZSP-C7PA2E-10-E		
15 m	JZSP-C7PA0E-15-E		JZSP-C7PA2E-15-E			
Cable installed away from load	20 m	JZSP-C7PA0E-20-E	JZSP-C7PA2E-20-E			
	For incremental encoder, or batteryless absolute encoder	3 m	JZSP-CVP01-03-E	JZSP-CVP11-03-E		
		5 m	JZSP-CVP01-05-E	JZSP-CVP11-05-E		
		10 m	JZSP-CVP01-10-E	JZSP-CVP11-10-E		
15 m		JZSP-CVP01-15-E	JZSP-CVP11-15-E			
20 m		JZSP-CVP01-20-E	JZSP-CVP11-20-E			
For absolute encoder		3 m	JZSP-CVP02-03-E* ³	JZSP-CVP12-03-E* ³		
		5 m	JZSP-CVP02-05-E* ³	JZSP-CVP12-05-E* ³		
		10 m	JZSP-CVP02-10-E* ³	JZSP-CVP12-10-E* ³		
		15 m	JZSP-CVP02-15-E* ³	JZSP-CVP12-15-E* ³		
		20 m	JZSP-CVP02-20-E* ³	JZSP-CVP12-20-E* ³		
SGM7A-15 to -70 1.5 kW to 7.0 kW	For incremental encoder, or batteryless absolute encoder	3 m	JZSP-CVP06-03-E	JZSP-CVP26-03-E		
		5 m	JZSP-CVP06-05-E	JZSP-CVP26-05-E		
		10 m	JZSP-CVP06-10-E	JZSP-CVP26-10-E		
		15 m	JZSP-CVP06-15-E	JZSP-CVP26-15-E		
		20 m	JZSP-CVP06-20-E	JZSP-CVP26-20-E		
	For absolute encoder: With Battery Case* ²	3 m	JZSP-CVP07-03-E* ³	JZSP-CVP27-03-E* ³		
		5 m	JZSP-CVP07-05-E* ³	JZSP-CVP27-05-E* ³		
		10 m	JZSP-CVP07-10-E* ³	JZSP-CVP27-10-E* ³		
		15 m	JZSP-CVP07-15-E* ³	JZSP-CVP27-15-E* ³		
		20 m	JZSP-CVP07-20-E* ³	JZSP-CVP27-20-E* ³		

*1. Use Flexible Cables for moving parts of machines, such as robots. The recommended bending radius (R) is 90 mm or larger.

*2. If a battery is connected to the host controller, the Battery Case is not required.

*3. You cannot use a right-angle connector for the encoder of a SGM7A-70A (7.0 kW) Servomotor. Use a straight connector.

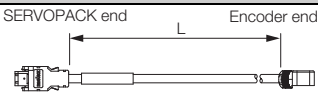
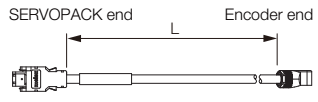
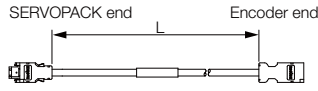
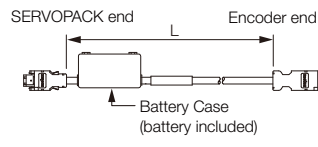
10.3.4 Relay Encoder Cable of 30 m to 50 m

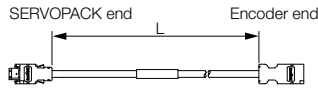
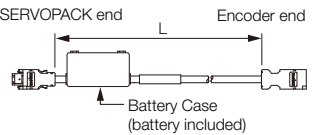
Servomotor Model	Name	Length (L)	Order Number	Appearance
SGM7A-A5 to -10 50 W to 1.0 kW	Encoder-end Cable (for all types of encoders) Cable installed toward load	0.3 m	JZSP-C7PRCD-E	
	Encoder-end Cable (for all types of encoders) Cable installed away from load	0.3 m	JZSP-C7PRCE-E	
	Cables with Connectors on Both Ends (for all types of encoders)	30 m	JZSP-UCMP00-30-E	
		40 m	JZSP-UCMP00-40-E	
		50 m	JZSP-UCMP00-50-E	
Cable with a Battery Case (Required when an absolute encoder is used.*2)	0.3 m	JZSP-CSP12-E		
SGM7A-15 to -70 1.5 kW to 7.0 kW	Encoder-end Cable (for all types of encoders)	0.3 m	JZSP-CVP01-E	
		0.3 m	JZSP-CVP02-E*1	
	Cables with Connectors on Both Ends (for all types of encoders)	30 m	JZSP-UCMP00-30-E	
		40 m	JZSP-UCMP00-40-E	
		50 m	JZSP-UCMP00-50-E	
Cable with a Battery Case (Required when an absolute encoder is used.*2)	0.3 m	JZSP-CSP12-E		

*1. You cannot use a right-angle connector for the encoder of a SGM7A-70A (7.0 kW) Servomotor. Use a straight connector.

*2. This Cable is not required if you use a Servomotor with a Batteryless Absolute Encoder, and you connect a battery to the host controller.

10.4 Cables for the SGM7P Servomotors

10.4.1 System Configurations

The cables shown below are required to connect a Servomotor to a SERVOPACK.

Encoder Cable of 20 m or Less

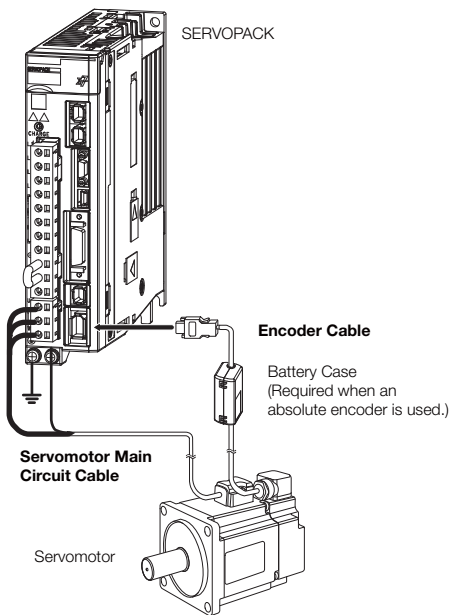

Encoder Cable of 30 m to 50 m (Relay Cable)

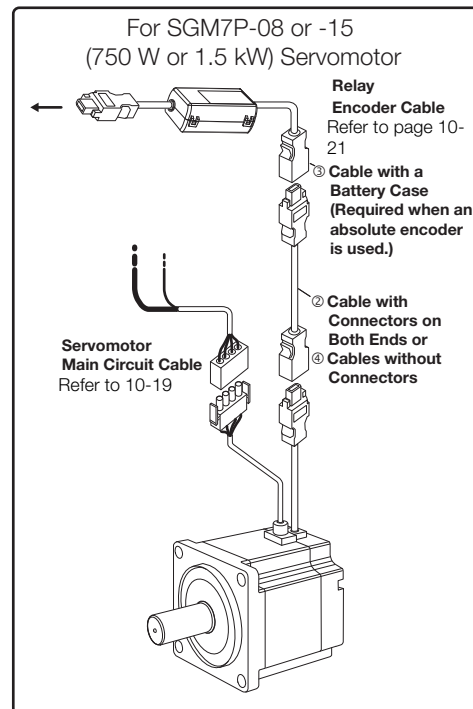
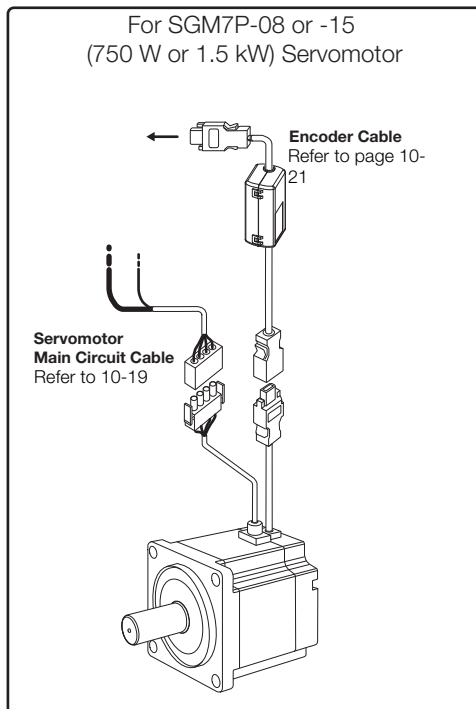
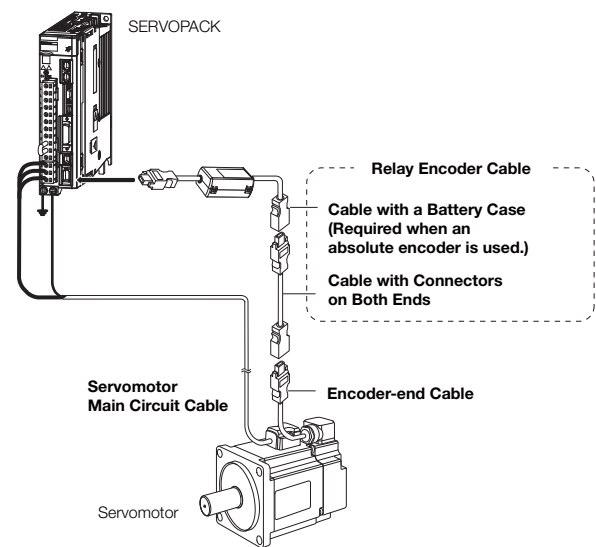

- Note: 1. If the Encoder Cable length exceeds 20 m, be sure to use a Relay Encoder Cable.
2. If you use a Servomotor Main Circuit Cable that exceeds 20 m, the intermittent duty zone in the torque-motor speed characteristics will become smaller because the voltage drop increases.
3. Refer to the following manual for the following information.
- Cable dimensional drawings and cable connection specifications
 - Order numbers and specifications of individual connectors for cables
 - Order numbers and specifications for wiring materials
- 📖 Σ -7-Series AC Servo Drive Peripheral Device Selection Manual (Manual No.: SIEP S80001 32)

10.4.2 Servomotor Main Circuit Cables

This section provides information on selecting a Servomotor Main Circuit Cable. Refer to the following manual for detailed information on Cables and for the wiring materials to make your own cables.

☞ Σ -7-Series Peripheral Device Selection Manual (Manual No.: SIEP S800001 32)

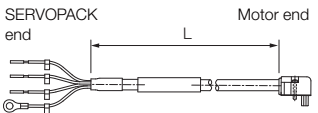
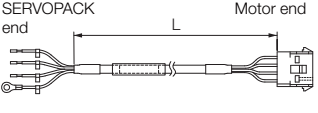
Servomotor Model	Name	Length (L)	Order Number		Appearance
			Standard Cable	Flexible Cable*	
SGM7P-01 100 W	For Servomotors without Holding Brakes	3 m	JZSP-CSM01-03-E	JZSP-CSM21-03-E	
		5 m	JZSP-CSM01-05-E	JZSP-CSM21-05-E	
		10 m	JZSP-CSM01-10-E	JZSP-CSM21-10-E	
		15 m	JZSP-CSM01-15-E	JZSP-CSM21-15-E	
		20 m	JZSP-CSM01-20-E	JZSP-CSM21-20-E	
		30 m	JZSP-CSM01-30-E	JZSP-CSM21-30-E	
		40 m	JZSP-CSM01-40-E	JZSP-CSM21-40-E	
50 m		JZSP-CSM01-50-E	JZSP-CSM21-50-E		
SGM7P-02 and -04 200 W, 400 W		3 m	JZSP-CSM02-03-E	JZSP-CSM22-03-E	
		5 m	JZSP-CSM02-05-E	JZSP-CSM22-05-E	
		10 m	JZSP-CSM02-10-E	JZSP-CSM22-10-E	
		15 m	JZSP-CSM02-15-E	JZSP-CSM22-15-E	
		20 m	JZSP-CSM02-20-E	JZSP-CSM22-20-E	
		30 m	JZSP-CSM02-30-E	JZSP-CSM22-30-E	
	40 m	JZSP-CSM02-40-E	JZSP-CSM22-40-E		
SGM7P-08 750 W	3 m	JZSP-CMM00-03-E	JZSP-CMM01-03-E		
	5 m	JZSP-CMM00-05-E	JZSP-CMM01-05-E		
	10 m	JZSP-CMM00-10-E	JZSP-CMM01-10-E		
	15 m	JZSP-CMM00-15-E	JZSP-CMM01-15-E		
	20 m	JZSP-CMM00-20-E	JZSP-CMM01-20-E		
	30 m	JZSP-CMM00-30-E	JZSP-CMM01-30-E		
	40 m	JZSP-CMM00-40-E	JZSP-CMM01-40-E		
SGM7P-15 1.5 kW	3 m	JZSP-CMM20-03-E	—		
	5 m	JZSP-CMM20-05-E	—		
	10 m	JZSP-CMM20-10-E	—		
	15 m	JZSP-CMM20-15-E	—		
	20 m	JZSP-CMM20-20-E	—		

Continued on next page.

* Use Flexible Cables for moving parts of machines, such as robots. The recommended bending radius (R) is 90 mm or larger.

10.4 Cables for the SGM7P Servomotors

10.4.2 Servomotor Main Circuit Cables

Continued from previous page.

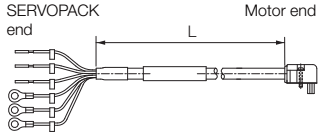
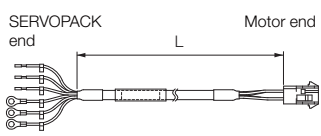
Servomotor Model	Name	Length (L)	Order Number		Appearance
			Standard Cable	Flexible Cable*	
SGM7P-01 100 W	For Servomotors with Holding Brakes	3 m	JZSP-CSM11-03-E	JZSP-CSM31-03-E	
		5 m	JZSP-CSM11-05-E	JZSP-CSM31-05-E	
		10 m	JZSP-CSM11-10-E	JZSP-CSM31-10-E	
		15 m	JZSP-CSM11-15-E	JZSP-CSM31-15-E	
		20 m	JZSP-CSM11-20-E	JZSP-CSM31-20-E	
		30 m	JZSP-CSM11-30-E	JZSP-CSM31-30-E	
		40 m	JZSP-CSM11-40-E	JZSP-CSM31-40-E	
50 m		JZSP-CSM11-50-E	JZSP-CSM31-50-E		
SGM7P-02 and -04 200 W, 400 W		3 m	JZSP-CSM12-03-E	JZSP-CSM32-03-E	
		5 m	JZSP-CSM12-05-E	JZSP-CSM32-05-E	
		10 m	JZSP-CSM12-10-E	JZSP-CSM32-10-E	
		15 m	JZSP-CSM12-15-E	JZSP-CSM32-15-E	
		20 m	JZSP-CSM12-20-E	JZSP-CSM32-20-E	
		30 m	JZSP-CSM12-30-E	JZSP-CSM32-30-E	
	40 m	JZSP-CSM12-40-E	JZSP-CSM32-40-E		
SGM7P-08 750 W	3 m	JZSP-CMM10-03-E	JZSP-CMM11-03-E		
	5 m	JZSP-CMM10-05-E	JZSP-CMM11-05-E		
	10 m	JZSP-CMM10-10-E	JZSP-CMM11-10-E		
	15 m	JZSP-CMM10-15-E	JZSP-CMM11-15-E		
	20 m	JZSP-CMM10-20-E	JZSP-CMM11-20-E		
	30 m	JZSP-CMM10-30-E	JZSP-CMM11-30-E		
	40 m	JZSP-CMM10-40-E	JZSP-CMM11-40-E		
SGM7P-15 1.5 kW	3 m	JZSP-CMM30-03-E	—		
	5 m	JZSP-CMM30-05-E	—		
	10 m	JZSP-CMM30-10-E	—		
	15 m	JZSP-CMM30-15-E	—		
	20 m	JZSP-CMM30-20-E	—		

* Use Flexible Cables for moving parts of machines, such as robots. The recommended bending radius (R) is 90 mm or larger.

10.4.3 Encoder Cables of 20 m or Less

Servomotor Model	Name	Length (L)	Order Number		Appearance
			Standard Cable	Flexible Cable* ¹	
SGM7P-01, -02, -04 100 W, 200 W, 400 W	For incremental encoder or for batteryless absolute encoder	3 m	JZSP-C7PI0D-03-E	JZSP-C7PI2D-03-E	
		5 m	JZSP-C7PI0D-05-E	JZSP-C7PI2D-05-E	
		10 m	JZSP-C7PI0D-10-E	JZSP-C7PI2D-10-E	
		15 m	JZSP-C7PI0D-15-E	JZSP-C7PI2D-15-E	
		20 m	JZSP-C7PI0D-20-E	JZSP-C7PI2D-20-E	
SGM7P-08, -15 750 W, 1500 W	Cable installed toward load	3 m	JZSP-CMP00-03-E	JZSP-CMP10-03-E	
		5 m	JZSP-CMP00-05-E	JZSP-CMP10-05-E	
		10 m	JZSP-CMP00-10-E	JZSP-CMP10-10-E	
		15 m	JZSP-CMP00-15-E	JZSP-CMP10-15-E	
		20 m	JZSP-CMP00-20-E	JZSP-CMP10-20-E	
SGM7P-01, -02, -04 100 W, 200 W, 400 W	For absolute encoder: With Battery Case* ²	3 m	JZSP-C7PA0D-03-E	JZSP-C7PA2D-03-E	
		5 m	JZSP-C7PA0D-05-E	JZSP-C7PA2D-05-E	
		10 m	JZSP-C7PA0D-10-E	JZSP-C7PA2D-10-E	
		15 m	JZSP-C7PA0D-15-E	JZSP-C7PA2D-15-E	
		20 m	JZSP-C7PA0D-20-E	JZSP-C7PA2D-20-E	
SGM7P-08, -15 750 W, 1500 W	Cable installed toward load	3 m	JZSP-CSP19-03-E	JZSP-CSP29-03-E	
		5 m	JZSP-CSP19-05-E	JZSP-CSP29-05-E	
		10 m	JZSP-CSP19-10-E	JZSP-CSP29-10-E	
		15 m	JZSP-CSP19-15-E	JZSP-CSP29-15-E	
		20 m	JZSP-CSP19-20-E	JZSP-CSP29-20-E	

*1. Use Flexible Cables for moving parts of machines, such as robots. The recommended bending radius (R) is 90 mm or larger.

*2. If a battery is connected to the host controller, the Battery Case is not required.

10.4.4 Relay Encoder Cables of 30 m to 50 m

Servomotor Model	Name	Length (L)	Order Number	Appearance
All SGM7P models	Encoder-end Cable (for all types of encoders) Cable installed toward load	0.3 m	JZSP-C7PRCD-E	
	Cable with Connectors on Both Ends (for all types of encoders)	30 m	JZSP-UCMP00-30-E	
		40 m	JZSP-UCMP00-40-E	
		50 m	JZSP-UCMP00-50-E	
	Cable with a Battery Case (Required only if an absolute encoder is used.*)	0.3 m	JZSP-CSP12-E	

* This Cable is not required if you use a Servomotor with a Batteryless Absolute Encoder, and you connect a battery to the host controller.

10.5 Cables for the SGM7G Servomotors

10.5.1 System Configurations

The cables shown below are required to connect a Servomotor to a SERVOPACK.

Encoder Cable of 20 m or Less

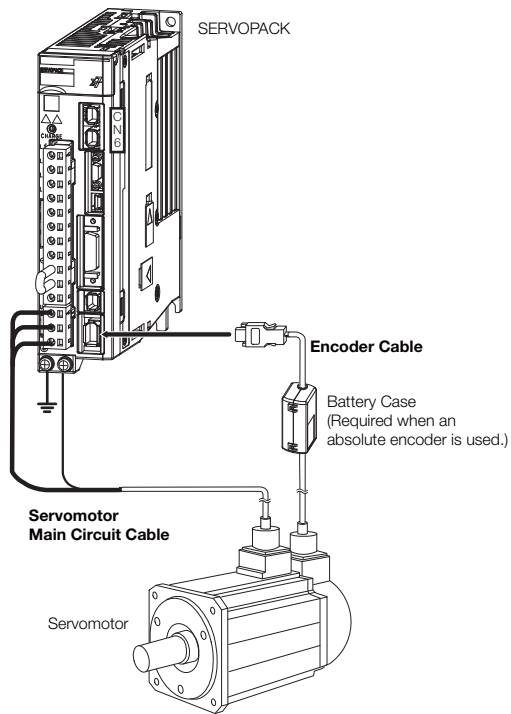

Encoder Cable of 30 m to 50 m (Relay Cable)

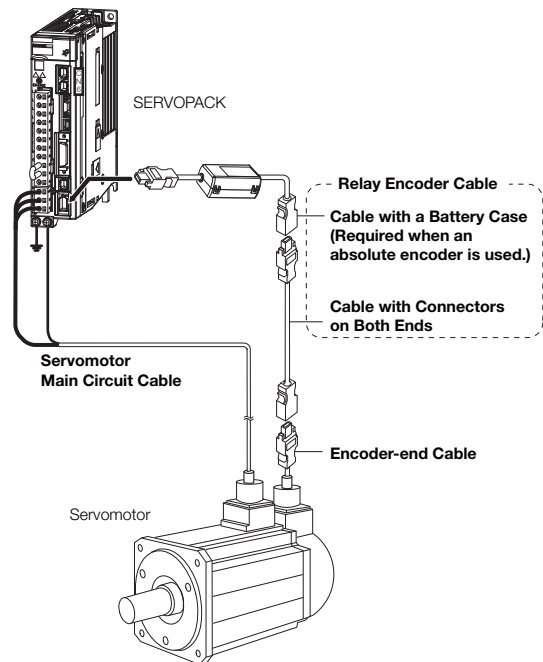

Note: 1. Cables with connectors on both ends that are compliant with an IP67 protective structure and European Safety Standards are not available from Yaskawa for the SGM7G Servomotors. You must make such a cable yourself. Use the Connectors specified by Yaskawa for these Servomotors. (These Connectors are compliant with the standards.) Yaskawa does not specify what wiring materials to use.

2. If the Encoder Cable length exceeds 20 m, be sure to use a Relay Encoder Cable.
3. If you use a Servomotor Main Circuit Cable that exceeds 20 m, the intermittent duty zone in the torque-motor speed characteristics will become smaller because the voltage drop increases.
4. Refer to the following manual for the following information.
 - Cable dimensional drawings and cable connection specifications
 - Order numbers and specifications of individual connectors for cables
 - Order numbers and specifications for wiring materials

📖 Σ -7-Series AC Servo Drive Peripheral Device Selection Manual (Manual No.: S1EP S800001 32)

10.5.2 Servomotor Main Circuit Cables

This section provides information on selecting a Servomotor Main Circuit Cable. Refer to the following manual for detailed information on Cables and for the wiring materials to make your own cables.

☞ Σ -7-Series Peripheral Device Selection Manual (Manual No.: SIEP S800001 32)

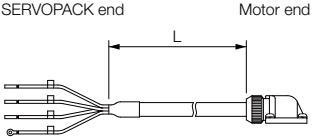
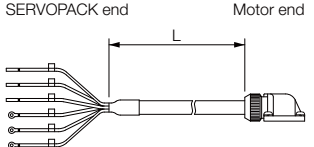
Servomotor Model	Name	Length (L)	Order Number*	Appearance
SGM7G-03 to -05 0.3 kW 0.45 kW	For Servomotors without Holding Brakes	3 m	JZSP-CVM21-03-E	
		5 m	JZSP-CVM21-05-E	
		10 m	JZSP-CVM21-10-E	
		15 m	JZSP-CVM21-15-E	
		20 m	JZSP-CVM21-20-E	
		30 m	JZSP-CVM21-30-E	
		40 m	JZSP-CVM21-40-E	
	50 m	JZSP-CVM21-50-E		
	For Servomotors with Holding Brakes	3 m	JZSP-CVM41-03-E	
		5 m	JZSP-CVM41-05-E	
		10 m	JZSP-CVM41-10-E	
		15 m	JZSP-CVM41-15-E	
		20 m	JZSP-CVM41-20-E	
		30 m	JZSP-CVM41-30-E	
40 m		JZSP-CVM41-40-E		
50 m	JZSP-CVM41-50-E			



Continued on next page.

* Use Flexible Cables for moving parts of machines, such as robots. The recommended bending radius (R) is 90 mm or larger.

10.5 Cables for the SGM7G Servomotors

10.5.2 Servomotor Main Circuit Cables

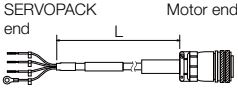
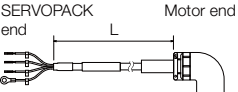
Continued from previous page.

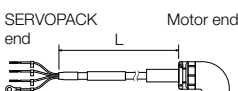
Servo-motor Model	Name	Connector Specifications	Length (L)	Order Number		Appearance
				Standard Cable	Flexible Cable*1	
SGM7G-09, -13 850 W, 1.3 kW	For Servomotors without Holding Brakes	Straight	3 m	JZSP-UVA101-03-E	JZSP-UVA121-03-E	
			5 m	JZSP-UVA101-05-E	JZSP-UVA121-05-E	
			10 m	JZSP-UVA101-10-E	JZSP-UVA121-10-E	
			15 m	JZSP-UVA101-15-E	JZSP-UVA121-15-E	
			20 m	JZSP-UVA101-20-E	JZSP-UVA121-20-E	
		Right-angle	3 m	JZSP-UVA102-03-E	JZSP-UVA122-03-E	
			5 m	JZSP-UVA102-05-E	JZSP-UVA122-05-E	
			10 m	JZSP-UVA102-10-E	JZSP-UVA122-10-E	
			15 m	JZSP-UVA102-15-E	JZSP-UVA122-15-E	
			20 m	JZSP-UVA102-20-E	JZSP-UVA122-20-E	
	For Servomotors with Holding Brakes (Set of Two Cables*2)	Straight	3 m	JZSP-UVA131-03-E	JZSP-UVA141-03-E	
			5 m	JZSP-UVA131-05-E	JZSP-UVA141-05-E	
			10 m	JZSP-UVA131-10-E	JZSP-UVA141-10-E	
			15 m	JZSP-UVA131-15-E	JZSP-UVA141-15-E	
20 m			JZSP-UVA131-20-E	JZSP-UVA141-20-E		
Right-angle		3 m	JZSP-UVA132-03-E	JZSP-UVA142-03-E		
		5 m	JZSP-UVA132-05-E	JZSP-UVA142-05-E		
		10 m	JZSP-UVA132-10-E	JZSP-UVA142-10-E		
		15 m	JZSP-UVA132-15-E	JZSP-UVA142-15-E		
		20 m	JZSP-UVA132-20-E	JZSP-UVA142-20-E		

Continued on next page.



*1. Use Flexible Cables for moving parts of machines, such as robots. The recommended bending radius (R) is 90 mm or larger.

*2. This order number is for a set of two cables (Main Power Supply Cable and Holding Brake Cable). When you purchase them separately, the order numbers for Main Power Supply Cables are the same as for a Servomotor without a Holding Brake.

The following order numbers are for a Holding Brake Cable. These Standard Cables are Flexible Cables.

- Cable with Straight Plug: JZSP-U7B23-□□-E
- Cable with Right-angle Plug: JZSP-U7B24-□□-E

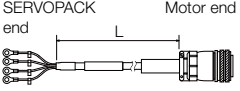
Continued from previous page.

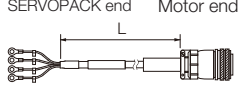
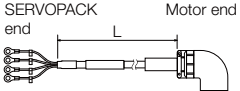
Servo- motor Model	Name	Conne- tor Spec- ifications	Length (L)	Order Number		Appearance
				Standard Cable	Flexible Cable* ¹	
SGM7G- 20 1.8 kW	For Servomotors without Holding Brakes	Straight	3 m	JZSP-UVA301-03-E	JZSP-UVA321-03-E	
			5 m	JZSP-UVA301-05-E	JZSP-UVA321-05-E	
			10 m	JZSP-UVA301-10-E	JZSP-UVA321-10-E	
			15 m	JZSP-UVA301-15-E	JZSP-UVA321-15-E	
			20 m	JZSP-UVA301-20-E	JZSP-UVA321-20-E	
		Right-angle	3 m	JZSP-UVA302-03-E	JZSP-UVA322-03-E	
			5 m	JZSP-UVA302-05-E	JZSP-UVA322-05-E	
			10 m	JZSP-UVA302-10-E	JZSP-UVA322-10-E	
			15 m	JZSP-UVA302-15-E	JZSP-UVA322-15-E	
			20 m	JZSP-UVA302-20-E	JZSP-UVA322-20-E	
	For Servomotors with Holding Brakes (Set of Two Cables* ²)	Straight	3 m	JZSP-UVA331-03-E	JZSP-UVA341-03-E	
			5 m	JZSP-UVA331-05-E	JZSP-UVA341-05-E	
			10 m	JZSP-UVA331-10-E	JZSP-UVA341-10-E	
			15 m	JZSP-UVA331-15-E	JZSP-UVA341-15-E	
			20 m	JZSP-UVA331-20-E	JZSP-UVA341-20-E	
		Right-angle	3 m	JZSP-UVA332-03-E	JZSP-UVA342-03-E	
			5 m	JZSP-UVA332-05-E	JZSP-UVA342-05-E	
			10 m	JZSP-UVA332-10-E	JZSP-UVA342-10-E	
			15 m	JZSP-UVA332-15-E	JZSP-UVA342-15-E	
			20 m	JZSP-UVA332-20-E	JZSP-UVA342-20-E	

Continued on next page.

*1. Use Flexible Cables for moving parts of machines, such as robots. The recommended bending radius (R) is 90 mm or larger.

*2. This order number is for a set of two cables (Main Power Supply Cable and Holding Brake Cable). When you purchase them separately, the order numbers for Main Power Supply Cables are the same as for a Servomotor without a Holding Brake.

The following order numbers are for a Holding Brake Cable. These Standard Cables are Flexible Cables.

- Cable with Straight Plug: JZSP-U7B23-□□-E
- Cable with Right-angle Plug: JZSP-U7B24-□□-E

Note: If you need a Cable with a length of 20 m to 50 m, consider the operating conditions and specify a suitable length.

10.5 Cables for the SGM7G Servomotors

10.5.2 Servomotor Main Circuit Cables

Continued from previous page.

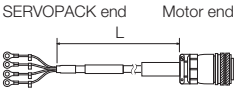
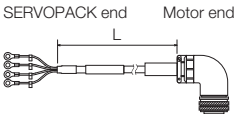
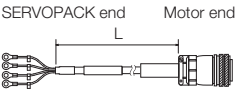
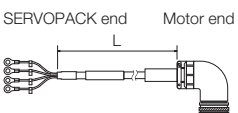
Servo-motor Model	Name	Connector Specifications	Length (L)	Order Number		Appearance
				Standard Cable	Flexible Cable*1	
SGM7G-30 2.4 kW (When using an SGD7S-200A SERVO-PACK.)	For Servomotors without Holding Brakes	Straight	3 m	JZSP-UVA601-03-E	JZSP-UVA621-03-E	
			5 m	JZSP-UVA601-05-E	JZSP-UVA621-05-E	
			10 m	JZSP-UVA601-10-E	JZSP-UVA621-10-E	
			15 m	JZSP-UVA601-15-E	JZSP-UVA621-15-E	
			20 m	JZSP-UVA601-20-E	JZSP-UVA621-20-E	
		Right-angle	3 m	JZSP-UVA602-03-E	JZSP-UVA622-03-E	
			5 m	JZSP-UVA602-05-E	JZSP-UVA622-05-E	
			10 m	JZSP-UVA602-10-E	JZSP-UVA622-10-E	
			15 m	JZSP-UVA602-15-E	JZSP-UVA622-15-E	
			20 m	JZSP-UVA602-20-E	JZSP-UVA622-20-E	
	For Servomotors with Holding Brakes (Set of Two Cables*2)	Straight	3 m	JZSP-UVA631-03-E	JZSP-UVA641-03-E	
			5 m	JZSP-UVA631-05-E	JZSP-UVA641-05-E	
			10 m	JZSP-UVA631-10-E	JZSP-UVA641-10-E	
			15 m	JZSP-UVA631-15-E	JZSP-UVA641-15-E	
			20 m	JZSP-UVA631-20-E	JZSP-UVA641-20-E	
		Right-angle	3 m	JZSP-UVA632-03-E	JZSP-UVA642-03-E	
			5 m	JZSP-UVA632-05-E	JZSP-UVA642-05-E	
			10 m	JZSP-UVA632-10-E	JZSP-UVA642-10-E	
			15 m	JZSP-UVA632-15-E	JZSP-UVA642-15-E	
			20 m	JZSP-UVA632-20-E	JZSP-UVA642-20-E	

Continued on next page.

*1. Use Flexible Cables for moving parts of machines, such as robots. The recommended bending radius (R) is 90 mm or larger.

*2. This order number is for a set of two cables (Main Power Supply Cable and Holding Brake Cable). When you purchase them separately, the order numbers for Main Power Supply Cables are the same as for a Servomotor without a Holding Brake.

The following order numbers are for a Holding Brake Cable. These Standard Cables are Flexible Cables.

- Cable with Straight Plug: JZSP-U7B23-□□-E
- Cable with Right-angle Plug: JZSP-U7B24-□□-E

Note: If you need a Cable with a length of 20 m to 50 m, consider the operating conditions and specify a suitable length.

Continued from previous page.

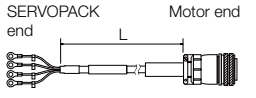
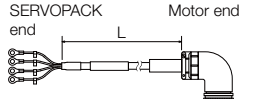
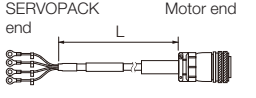
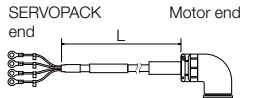
Servo- motor Model	Name	Conne- tor Spec- ifications	Length (L)	Order Number		Appearance
				Standard Cable	Flexible Cable* ¹	
SGM7G- 30 and -44 2.9 kW, 4.4 kW	For Servomotors without Holding Brakes	Straight	3 m	JZSP-UVA701-03-E	JZSP-UVA721-03-E	
			5 m	JZSP-UVA701-05-E	JZSP-UVA721-05-E	
			10 m	JZSP-UVA701-10-E	JZSP-UVA721-10-E	
			15 m	JZSP-UVA701-15-E	JZSP-UVA721-15-E	
			20 m	JZSP-UVA701-20-E	JZSP-UVA721-20-E	
		Right-angle	3 m	JZSP-UVA702-03-E	JZSP-UVA722-03-E	
			5 m	JZSP-UVA702-05-E	JZSP-UVA722-05-E	
			10 m	JZSP-UVA702-10-E	JZSP-UVA722-10-E	
			15 m	JZSP-UVA702-15-E	JZSP-UVA722-15-E	
			20 m	JZSP-UVA702-20-E	JZSP-UVA722-20-E	
	For Servomotors with Holding Brakes (Set of Two Cables * ²)	Straight	3 m	JZSP-UVA731-03-E	JZSP-UVA741-03-E	
			5 m	JZSP-UVA731-05-E	JZSP-UVA741-05-E	
			10 m	JZSP-UVA731-10-E	JZSP-UVA741-10-E	
			15 m	JZSP-UVA731-15-E	JZSP-UVA741-15-E	
			20 m	JZSP-UVA731-20-E	JZSP-UVA741-20-E	
		Right-angle	3 m	JZSP-UVA732-03-E	JZSP-UVA742-03-E	
			5 m	JZSP-UVA732-05-E	JZSP-UVA742-05-E	
			10 m	JZSP-UVA732-10-E	JZSP-UVA742-10-E	
			15 m	JZSP-UVA732-15-E	JZSP-UVA742-15-E	
			20 m	JZSP-UVA732-20-E	JZSP-UVA742-20-E	

Continued on next page.

*1. Use Flexible Cables for moving parts of machines, such as robots. The recommended bending radius (R) is 90 mm or larger.

*2. This order number is for a set of two cables (Main Power Supply Cable and Holding Brake Cable). When you purchase them separately, the order numbers for Main Power Supply Cables are the same as for a Servomotor without a Holding Brake.

The following order numbers are for a Holding Brake Cable. These Standard Cables are Flexible Cables.

- Cable with Straight Plug: JZSP-U7B23-□□-E
- Cable with Right-angle Plug: JZSP-U7B24-□□-E

Note: If you need a Cable with a length of 20 m to 50 m, consider the operating conditions and specify a suitable length.

10.5 Cables for the SGM7G Servomotors

10.5.2 Servomotor Main Circuit Cables

Continued from previous page.

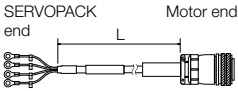
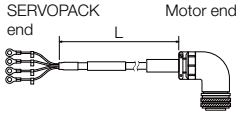
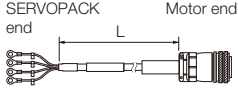
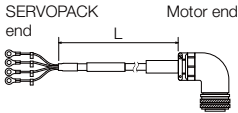
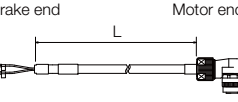
Servo-motor Model	Name	Connector Specifications	Length (L)	Order Number		Appearance
				Standard Cable	Flexible Cable*1	
SGM7G-55 and -75 5.5 kW, 7.5 kW	For Servomotors without Holding Brakes	Straight	3 m	JZSP-UVAA01-03-E	JZSP-UVAA21-03-E	
			5 m	JZSP-UVAA01-05-E	JZSP-UVAA21-05-E	
			10 m	JZSP-UVAA01-10-E	JZSP-UVAA21-10-E	
			15 m	JZSP-UVAA01-15-E	JZSP-UVAA21-15-E	
			20 m	JZSP-UVAA01-20-E	JZSP-UVAA21-20-E	
		Right-angle	3 m	JZSP-UVAA02-03-E	JZSP-UVAA22-03-E	
			5 m	JZSP-UVAA02-05-E	JZSP-UVAA22-05-E	
			10 m	JZSP-UVAA02-10-E	JZSP-UVAA22-10-E	
			15 m	JZSP-UVAA02-15-E	JZSP-UVAA22-15-E	
			20 m	JZSP-UVAA02-20-E	JZSP-UVAA22-20-E	
	For Servomotors with Holding Brakes (Set of Two Cables*2)	Straight	3 m	JZSP-UVAA31-03-E	JZSP-UVAA41-03-E	
			5 m	JZSP-UVAA31-05-E	JZSP-UVAA41-05-E	
			10 m	JZSP-UVAA31-10-E	JZSP-UVAA41-10-E	
			15 m	JZSP-UVAA31-15-E	JZSP-UVAA41-15-E	
20 m			JZSP-UVAA31-20-E	JZSP-UVAA41-20-E		
Right-angle		3 m	JZSP-UVAA32-03-E	JZSP-UVAA42-03-E		
		5 m	JZSP-UVAA32-05-E	JZSP-UVAA42-05-E		
		10 m	JZSP-UVAA32-10-E	JZSP-UVAA42-10-E		
			15 m	JZSP-UVAA32-15-E	JZSP-UVAA42-15-E	
		20 m	JZSP-UVAA32-20-E	JZSP-UVAA42-20-E		

Continued on next page.

*1. Use Flexible Cables for moving parts of machines, such as robots. The recommended bending radius (R) is 90 mm or larger.

*2. This order number is for a set of two cables (Main Power Supply Cable and Holding Brake Cable). When you purchase them separately, the order numbers for Main Power Supply Cables are the same as for a Servomotor without a Holding Brake.

The following order numbers are for a Holding Brake Cable. These Standard Cables are Flexible Cables.

- Cable with Straight Plug: JZSP-U7B23-□□-E
- Cable with Right-angle Plug: JZSP-U7B24-□□-E

Note: If you need a Cable with a length of 20 m to 50 m, consider the operating conditions and specify a suitable length.

Continued from previous page.

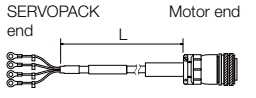
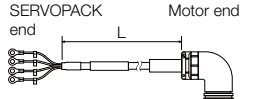
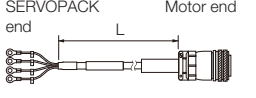
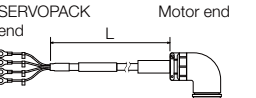
Servo-motor Model	Name	Connector Specifications	Length (L)	Order Number		Appearance
				Standard Cable	Flexible Cable* ¹	
SGM7G-1A and -1E 11 kW, 15 kW	For Servomotors without Holding Brakes	Straight	3 m	JZSP-UVAB01-03-E	JZSP-UVAB21-03-E	
			5 m	JZSP-UVAB01-05-E	JZSP-UVAB21-05-E	
			10 m	JZSP-UVAB01-10-E	JZSP-UVAB21-10-E	
			15 m	JZSP-UVAB01-15-E	JZSP-UVAB21-15-E	
			20 m	JZSP-UVAB01-20-E	JZSP-UVAB21-20-E	
		Right-angle	3 m	JZSP-UVAB02-03-E	JZSP-UVAB22-03-E	
			5 m	JZSP-UVAB02-05-E	JZSP-UVAB22-05-E	
			10 m	JZSP-UVAB02-10-E	JZSP-UVAB22-10-E	
			15 m	JZSP-UVAB02-15-E	JZSP-UVAB22-15-E	
			20 m	JZSP-UVAB02-20-E	JZSP-UVAB22-20-E	
	For Servomotors with Holding Brakes (Set of Two Cables* ²)	Straight	3 m	JZSP-UVAB31-03-E	JZSP-UVAB41-03-E	
			5 m	JZSP-UVAB31-05-E	JZSP-UVAB41-05-E	
			10 m	JZSP-UVAB31-10-E	JZSP-UVAB41-10-E	
			15 m	JZSP-UVAB31-15-E	JZSP-UVAB41-15-E	
			20 m	JZSP-UVAB31-20-E	JZSP-UVAB41-20-E	
		Right-angle	3 m	JZSP-UVAB32-03-E	JZSP-UVAB42-03-E	
			5 m	JZSP-UVAB32-05-E	JZSP-UVAB42-05-E	
			10 m	JZSP-UVAB32-10-E	JZSP-UVAB42-10-E	
			15 m	JZSP-UVAB32-15-E	JZSP-UVAB42-15-E	
			20 m	JZSP-UVAB32-20-E	JZSP-UVAB42-20-E	

*1. Use Flexible Cables for moving parts of machines, such as robots. The recommended bending radius (R) is 90 mm or larger.



*2. This order number is for a set of two cables (Main Power Supply Cable and Holding Brake Cable). When you purchase them separately, the order numbers for Main Power Supply Cables are the same as for a Servomotor without a Holding Brake.

The following order numbers are for a Holding Brake Cable. These Standard Cables are Flexible Cables.

- Cable with Straight Plug: JZSP-U7B23-□□-E
- Cable with Right-angle Plug: JZSP-U7B24-□□-E

Note: If you need a Cable with a length of 20 m to 50 m, consider the operating conditions and specify a suitable length.

10.5.3 Encoder Cables of 20 m or Less

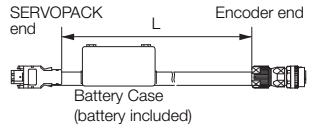
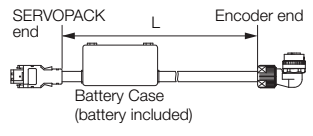
Servomotor Model	Name	Length (L)	Order Number		Appearance	
			Standard Cable	Flexible Cable* ¹		
All SGM7G models	For incremental encoder or for batteryless absolute encoder	3 m	JZSP-CVP01-03-E	JZSP-CVP11-03-E		
		5 m	JZSP-CVP01-05-E	JZSP-CVP11-05-E		
		10 m	JZSP-CVP01-10-E	JZSP-CVP11-10-E		
		15 m	JZSP-CVP01-15-E	JZSP-CVP11-15-E		
		20 m	JZSP-CVP01-20-E	JZSP-CVP11-20-E		
		3 m	JZSP-CVP02-03-E	JZSP-CVP12-03-E		
		5 m	JZSP-CVP02-05-E	JZSP-CVP12-05-E		
		10 m	JZSP-CVP02-10-E	JZSP-CVP12-10-E		
	15 m	JZSP-CVP02-15-E	JZSP-CVP12-15-E			
	For absolute encoder: With Battery Case* ²	3 m	JZSP-CVP06-03-E	JZSP-CVP26-03-E		
		5 m	JZSP-CVP06-05-E	JZSP-CVP26-05-E		
		10 m	JZSP-CVP06-10-E	JZSP-CVP26-10-E		
		15 m	JZSP-CVP06-15-E	JZSP-CVP26-15-E		
		3 m	JZSP-CVP07-03-E	JZSP-CVP27-03-E		
		5 m	JZSP-CVP07-05-E	JZSP-CVP27-05-E		
		10 m	JZSP-CVP07-10-E	JZSP-CVP27-10-E		
15 m		JZSP-CVP07-15-E	JZSP-CVP27-15-E			
		20 m	JZSP-CVP07-20-E	JZSP-CVP27-20-E		

*1. Use Flexible Cables for moving parts of machines, such as robots. The recommended bending radius (R) is 90 mm or larger.

*2. If a battery is connected to the host controller, the Battery Case is not required.

10.5.4 Relay Encoder Cables of 30 m to 50 m

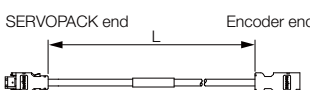
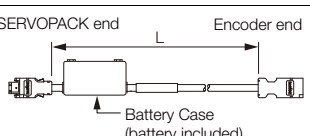
Servomotor Model	Name	Length (L)	Order Number	Appearance
All SGM7G models	Encoder-end Cable (for all types of encoders)	0.3 m	JZSP-CVP01-E	
			JZSP-CVP02-E	
	Cable with Connectors on Both Ends (for all types of encoders)	30 m	JZSP-UCMP00-30-E	
		40 m	JZSP-UCMP00-40-E	
		50 m	JZSP-UCMP00-50-E	
Cable with a Battery Case (Required only if an absolute encoder is used.)*	0.3 m	JZSP-CSP12-E		

* This Cable is not required if you use a Servomotor with a Batteryless Absolute Encoder, and you connect a battery to the host controller.

10.6 Cables for the SGMMV Servomotors

10.6.1 System Configurations

The cables shown below are required to connect a Servomotor to a SERVOPACK.

Encoder Cable of 20 m or Less

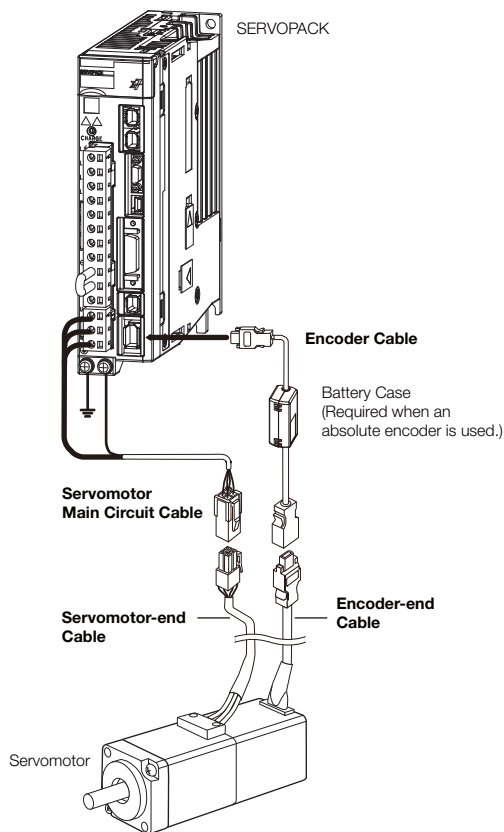

Encoder Cable of 30 m to 50 m (Relay Cable)

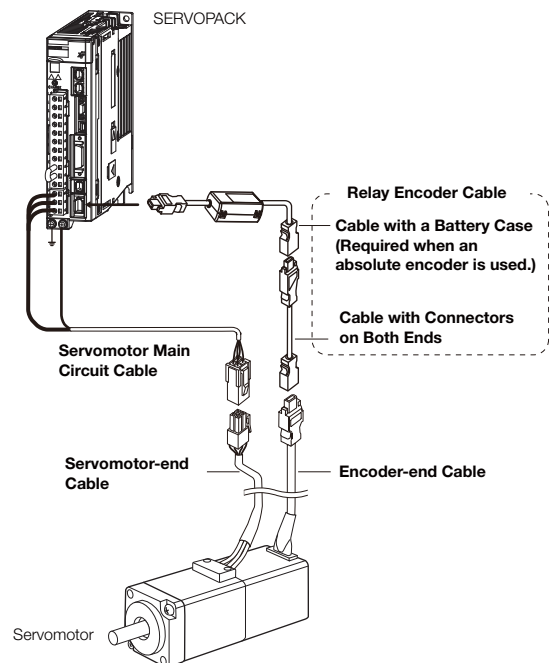

Note: 1. If the Encoder Cable length exceeds 20 m, be sure to use a Relay Encoder Cable.

2. If you use a Servomotor Main Circuit Cable that exceeds 20 m, the intermittent duty zone in the torque-speed characteristics will become smaller because the voltage drop increases.

3. Refer to the following manual for the following information.

- Cable dimensional drawings and cable connection specifications
- Order numbers and specifications of individual connectors for cables
- Order numbers and specifications for wiring materials

📖 *Σ-7-Series AC Servo Drive Peripheral Device Selection Manual* (Manual No.: SIEP S800001 32)

10.6.2 Servomotor Main Circuit Cables

Name	Length (L)	Order Number		Appearance
		Standard Cable	Flexible Cable*	
For Servomotors without Holding Brakes	3 m	JZSP-CF2M00-03-E	JZSP-CF2M20-03-E	
	5 m	JZSP-CF2M00-05-E	JZSP-CF2M20-05-E	
	10 m	JZSP-CF2M00-10-E	JZSP-CF2M20-10-E	
	15 m	JZSP-CF2M00-15-E	JZSP-CF2M20-15-E	
	20 m	JZSP-CF2M00-20-E	JZSP-CF2M20-20-E	
	30 m	JZSP-CF2M00-30-E	JZSP-CF2M20-30-E	
	40 m	JZSP-CF2M00-40-E	JZSP-CF2M20-40-E	
	50 m	JZSP-CF2M00-50-E	JZSP-CF2M20-50-E	
For Servomotors with Holding Brakes	3 m	JZSP-CF2M03-03-E	JZSP-CF2M23-03-E	
	5 m	JZSP-CF2M03-05-E	JZSP-CF2M23-05-E	
	10 m	JZSP-CF2M03-10-E	JZSP-CF2M23-10-E	
	15 m	JZSP-CF2M03-15-E	JZSP-CF2M23-15-E	
	20 m	JZSP-CF2M03-20-E	JZSP-CF2M23-20-E	
	30 m	JZSP-CF2M03-30-E	JZSP-CF2M23-30-E	
	40 m	JZSP-CF2M03-40-E	JZSP-CF2M23-40-E	
	50 m	JZSP-CF2M03-50-E	JZSP-CF2M23-50-E	

* Use Flexible Cables for moving parts of machines, such as robots. The recommended bending radius (R) is 90 mm or larger.

10.6.3 Encoder Cables of 20 m or Less

Name	Length (L)	Order Number		Appearance
		Standard Cable	Flexible Cable*	
Cables with Connectors on Both Ends (for incremental encoder)	3 m	JZSP-CMP00-03-E	JZSP-CMP10-03-E	
	5 m	JZSP-CMP00-05-E	JZSP-CMP10-05-E	
	10 m	JZSP-CMP00-10-E	JZSP-CMP10-10-E	
	15 m	JZSP-CMP00-15-E	JZSP-CMP10-15-E	
	20 m	JZSP-CMP00-20-E	JZSP-CMP10-20-E	
Cables with Connectors on Both Ends (for absolute encoder: With Battery Case)	3 m	JZSP-CSP19-03-E	JZSP-CSP29-03-E	
	5 m	JZSP-CSP19-05-E	JZSP-CSP29-05-E	
	10 m	JZSP-CSP19-10-E	JZSP-CSP29-10-E	
	15 m	JZSP-CSP19-15-E	JZSP-CSP29-15-E	
	20 m	JZSP-CSP19-20-E	JZSP-CSP29-20-E	

* Use Flexible Cables for moving parts of machines, such as robots. The recommended bending radius (R) is 68 mm or larger.

10.6.4 Relay Encoder Cables of 30 m to 50 m

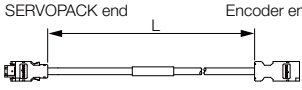
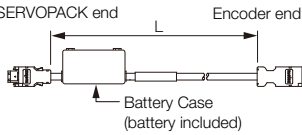
Name	Length (L)	Order Number	Appearance
Cables with Connectors on Both Ends (for incremental or absolute encoder)	30 m	JZSP-UCMP00-30-E	
	40 m	JZSP-UCMP00-40-E	
	50 m	JZSP-UCMP00-50-E	
Cable with a Battery Case (Required when an absolute encoder is used.)*	0.3 m	JZSP-CSP12-E	

* This Cable is not required if a battery is connected to the host controller.

10.7 Wiring Servomotors and SERVOPACKs

10.7.1 Wiring Precautions

CAUTION

- Do not connect the Servomotor directly to an industrial power supply. Doing so will destroy the Servomotor. You cannot operate a Servomotor without a SERVOPACK that is designed for it.

General Precautions

- Never perform any wiring work while the power supply is ON.
- Always connect the Servomotor Main Circuit Cable before you connect the Encoder Cable. If you connect the Encoder Cable first, the encoder may be damaged due to the difference in electrical potential from the FG.
- Never touch the connector pins on the Servomotor directly with your hands. Particularly the encoder may be damaged by static electricity.
- For the following Servomotor models, use the screws to secure the cable connectors to the Servomotor. Make sure that they are securely attached.
 - SGM7J Servomotors
 - SGM7A Servomotors up to 1.0 kW
 - SGM7G Servomotors up to 450 W
 - SGM7P Servomotors up to 400 W
 If they are not securely attached, the protective structure specifications may not be satisfied.
- Do not remove rubber packings or O-rings. Also, make sure that rubber packings and O-rings do not come off. If the rubber packings or O-rings are not securely attached, the protective structure specifications may not be satisfied.
- Separate the Servomotor Main Circuit Cable from the I/O Signal Cables and Encoder Cable by at least 30 cm.
- Do not connect magnetic contactors, reactors, or other devices on the cables that connect the SERVOPACK and Servomotor. Failure to observe this caution may result in malfunction or damage.
- Do not subject the cables to excessive bending stress or tension. The conductors in the Encoder Cable and Servomotor Main Circuit Cable are as thin as 0.2 mm² or 0.3 mm². Wire them so that they are not subjected to excessive stress.
- If you secure the cables with cable ties, protect the cables with cushioning material.
- If the cable will be bent repeatedly, e.g., if the Servomotor will move in the machine, use Flexible Cables. If you do not use Flexible Cables, the cables may break.
- Before you connect the wires, make sure that there are no mistakes in the wiring.
- Always use the connectors specified by Yaskawa and insert them correctly.
- When you connect a connector, check it to make sure there is no foreign matter, such as metal clippings, inside.
- The connectors are made of resin. To prevent damage, do not apply any strong impact.
- Perform all wiring so that stress is not applied to the connectors. The connectors may break if they are subjected to stress.
- If you move the Servomotor while the cables are connected, always hold onto the main body of the Servomotor. If you lift the Servomotor by the cables when you move it, the connectors may be damaged or the cables may be broken.

Grounding Precautions

The ground terminal on the SERVOPACK is used to ground the Servomotor.

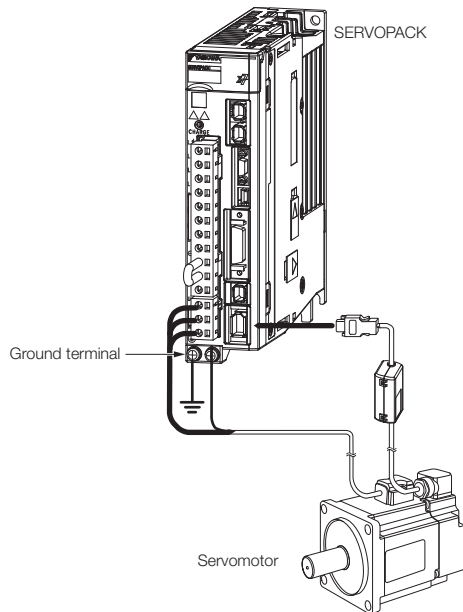

Precautions for Standard Cables

Do not use standard cables in applications that require a high degree of flexibility, such as twisting and turning, or in which the cables themselves must move. When you use Standard Cables, observe the recommended bending radius given in the following table and perform all wiring so that stress is not applied to the cables. Use the cables so that they are not repeatedly bent.

Cable Diameter	Recommended Bending Radius [R]
Less than 8 mm	15 mm min.
8 mm	20 mm min.
Over 8 mm	Cable diameter × 3 mm min.

Precautions for Flexible Cables

- The Flexible Cables have a service life of 10,000,000 operations minimum when used at the recommended bending radius of 90 mm or larger under the following test conditions. The service life of a Flexible Cable is reference data under special test conditions. The service life of a Flexible Cable greatly depends on the amount of mechanical shock, how the cable is attached, and how the cable is secured.

Test Conditions

- One end of the cable is repeatedly moved forward and backward for 320 mm using the test equipment shown in the following figure.
- The lead wires are connected in series, and the number of cable return operations until a lead wire breaks are counted. One round trip is counted as one bend.

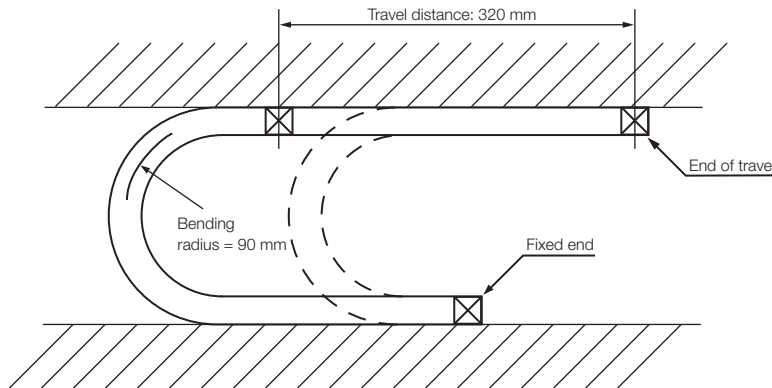

Note: The service life of a Flexible Cable indicates the number of bends while the lead wires are electrically charged for which no cracks or damage that affects the performance of the cable sheathing occur. Breaking of the shield wire is not considered.

- Straighten out the Flexible Cable when you connect it. If the cable is connected while it is twisted, it will break faster. Check the indication on the cable surface to make sure that the cable is not twisted.
- Do not secure the portions of the Flexible Cable that move. Stress will accumulate at the point that is secured, and the cable will break faster. Secure the cable in as few locations as possible.
- If a Flexible Cable is too long, looseness will cause it to break faster. If the Flexible Cable is too short, stress at the points where it is secured will cause it to break faster. Adjust the cable length to the optimum value.
- Do not allow Flexible Cables to interfere with each other. Interference will restrict the motion of the cables, causing them to break faster. Separate the cables sufficiently, or provide partitions between them when wiring.

10.7.2 Wiring Procedure

This manual provides the wiring procedure only for the Servomotors.

Refer to the SERVOPACK manual for information on wiring the SERVOPACKs.

1. Remove the protective cap and protective tape from the Servomotor connectors.

- Information**
- Some models of Servomotors do not have protective tape.
 - The number of connectors depends on the model of the Servomotor.

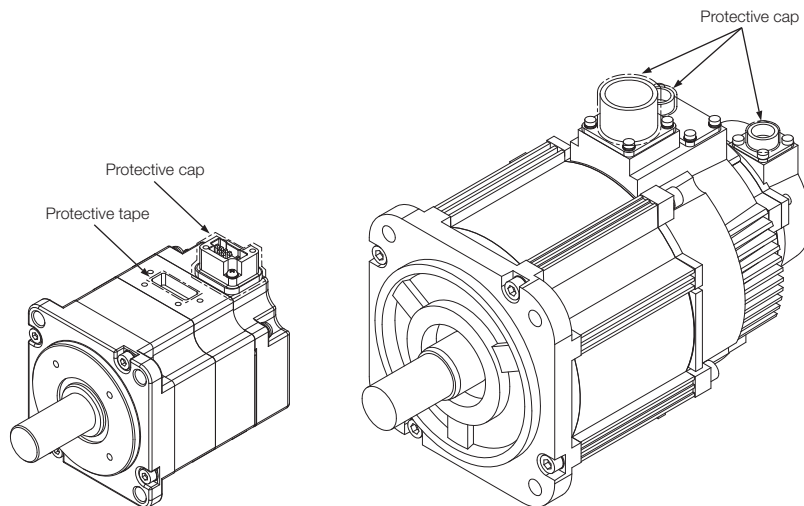

2. Attach the Servomotor Main Circuit Cable and tighten the screws.

Pay attention to the orientation of the cable (i.e., load or non-load side) when you attach it. Refer to the following table for the tightening torque.

Servomotor Model	Tightening Torque	Servomotor Model	Tightening Torque
SGM7J-A5 to -06	0.15 N·m	SGM7G-03, -05	0.44 N·m
SGM7J-08	0.33 N·m	SGM7P-01 to -04 with design revision order A	0.15 N·m
SGM7A-A5 to -06	0.15 N·m	SGM7P-01 to -04 with design revision order E	0.18 N·m
SGM7A-08 to -10	0.33 N·m		

• Leads on Non-load Side

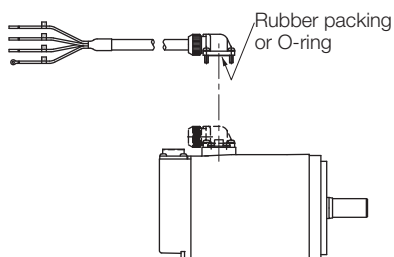

• Leads on Load Side

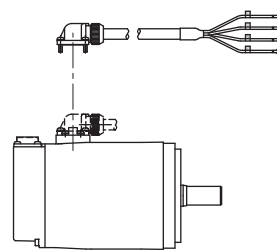

- Information**
- There are two Servomotor Main Circuit Cables for the SGM7G-09 to SGM7G-1E Servomotors with Holding Brakes (the Main Power Supply Cable and the Holding Brake Cable). Attach both of them.
 - The SGM7A-70 Servomotors have a Servomotor Main Circuit Cable and a Fan Cable. Attach both of them.
 - The degree of protection depends on the design revision order for the SGM7P-01 to -04 Servomotors, and therefore the tightening torque is different.

10.7.2 Wiring Procedure

3. Attach the Encoder Cable and tighten the screws. Pay attention to the orientation of the cable (i.e., load or non-load side) when you attach it.

- Tightening torque:

SGM7J and SGM7A Servomotors up to 1.0 kW and SGM7P Servomotors up to 400 W: 0.15 N·m

To extend the Encoder Cable to from 30 to 50 m, proceed to step 4.

4. Connect a Cable with Connectors on Both Ends to the Encoder Cable.

5. If necessary, connect a Cable with a Battery Case to the Cable with Connectors on Both Ends.

This concludes the procedure.

Maintenance and Inspection



This chapter describes the maintenance, inspection, and disposal of a Servomotor.

11.1	Periodic Inspections	11-2
11.2	Service Lives of Parts	11-3
11.3	Disposing of Servomotors	11-4

11.1 Periodic Inspections

The following table gives the periodic inspection items for a Servomotor. The inspection periods given in the table are guidelines. Determine the optimum inspection periods based on the application conditions and environment.

 CAUTION
<ul style="list-style-type: none"> ● Before you perform any maintenance or inspection work, turn OFF the power supply, confirm that the CHARGE indicator on the front of the SERVOPACK has gone out, and then use a tester to check the voltage between the positive and negative terminals on the SERVOPACK. Start inspection work only after you have confirmed that the main circuit voltage has dropped. If there is any main circuit voltage left, the risk of electric shock still exists. Do not touch the Servomotor or any wiring. ● All inspection and maintenance work must be performed only by qualified engineers. There is a risk of electric shock or injury. ● Contact your Yaskawa representative for help with failures, repairs, or part replacement.

Item	Inspection Period	Basic Inspection and Maintenance Procedure	Remarks
Check the coupling between the Servomotor and the machine.	Before starting operation	<ul style="list-style-type: none"> • Make sure that there are no loose mounting screws between the Servomotor and machine. • Make sure that there is no looseness in the coupling between the Servomotor and machine. • Make sure that there is no misalignment. 	-
Check for vibration and noise.	Daily	Inspect by touching and by listening.	There should be no more vibration or noise than normal.
Exterior	Check for dirt and grime.	Clean off the dirt and grime with a cloth or pressurized air.	-
Measure the insulation resistance.	At least once a year	Disconnect the Servomotor from the SERVOPACK and measure the insulation resistance at 500 V with an insulation resistance meter. (Measurement method: Measure the resistance between phase U, V, or W on the Servomotor's power line and FG.) The insulation is normal if the resistance is 10 MΩ or higher.	If the resistance is less than 10 MΩ, contact your Yaskawa representative.
Replace the oil seal.	At least once every 5,000 hours	Contact your Yaskawa representative.	This inspection applies only to Servomotors with Oil Seals.
Overhaul	At least once every 5 years or every 20,000 hours	Contact your Yaskawa representative.	-

11.2 Service Lives of Parts

The following table gives the standard service lives of the parts of the Servomotor. Contact your Yaskawa representative using the following table as a guide. After an examination of the part in question, we will determine whether the part should be replaced. Even if the service life of a part has not expired, replacement may be required if abnormalities occur. The standard service lives in the table are only for reference. The actual service lives will depend on the application conditions and environment.

Part	Standard Service Life	Remarks
Bearing	20,000 hours	The service life is affected by operating conditions. Check for abnormal sounds and vibration during inspections.
Oil Seal	5,000 hours	The service life is affected by operating conditions. Check for oil leaks during inspections.
Holding Brake	20,000 hours	The service life is affected by operating conditions. Check for abnormal sounds and vibration during inspections. Confirm that the brake is released when power is supplied and check for any changes in the operating time of the brake.

11.3 Disposing of Servomotors

When disposing of a Servomotor, treat it as ordinary industrial waste. However, local ordinances and national laws must be observed. Implement all labeling and warnings as a final product as required.

Appendices

12

The appendices provide additional information on Servomotors with Gears and reference information on selecting Servomotor capacity.

12.1 Terminology and Data for Servomotors with Gears . . 12-2

- 12.1.1 Terminology for Servomotors with Low-backlash Gears 12-2
- 12.1.2 Noise Data 12-2
- 12.1.3 Efficiency 12-3

12.2 Reference Information for Servomotor Capacity Selection . . . 12-4

- 12.2.1 Formulas Required to Select the Servomotor Capacity 12-4
- 12.2.2 GD^2 for Simple Diagrams 12-5
- 12.2.3 Conversions between Engineering Units and SI Units 12-6
- 12.2.4 Application Examples by Type of Application . . 12-7

12.1 Terminology and Data for Servomotors with Gears

12.1.1 Terminology for Servomotors with Low-backlash Gears

Item	Measurement Method and Definition	Typical Value for Low-Backlash Gear
Rated Torque (N·m)	The rated output torque of the Servomotor is the input torque to the gear. The rated torque is this value multiplied by the inverse of the gear ratio and efficiency.	-
Lost Motion (arc-min)	The difference in the torsion angle with a $\pm 5\%$ rated torque load (maximum value at any four positions during output).	3 max.
Torsion Rigidity (arc-min)	Higher torsion angle value on one side with a \pm rated torque load.	10 max.
Angle Transmission Deviation Accuracy (arc-min)	The difference between the absolute accuracy and the accuracy for one rotation under no-load conditions during output.	6 max.

Refer to the following graph for lost motion and torsion rigidity.

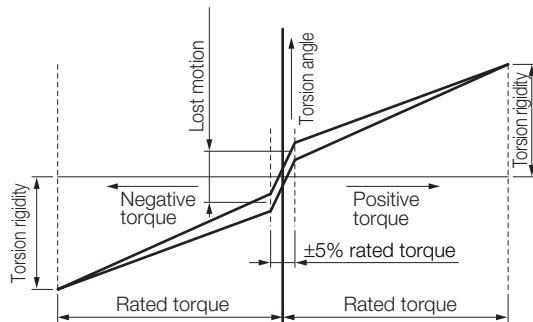

12.1.2 Noise Data

The following noise data for Servomotors with Gears is only for reference. The data may vary slightly depending on the capacity and gear ratio of the Servomotor.

Measurement Conditions

- Scale A: 50 cm
- Ground noise: 28 dB

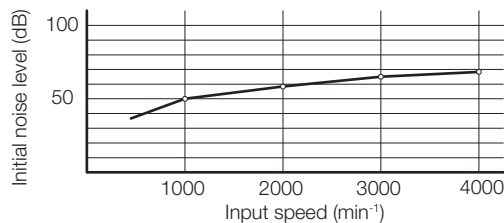

12.1.3 Efficiency

The output torque and motor speed produce the following trends in efficiency. The values in the tables of ratings and specifications for Servomotors with Gears are given at the rated motor torque and rated motor speed.

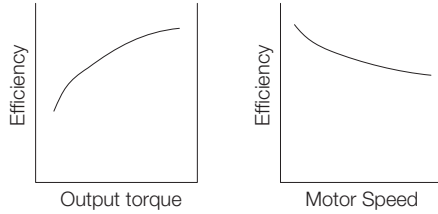

12.2 Reference Information for Servomotor Capacity Selection

12.2.1 Formulas Required to Select the Servomotor Capacity

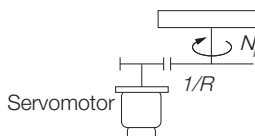
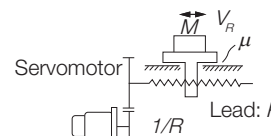
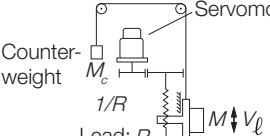
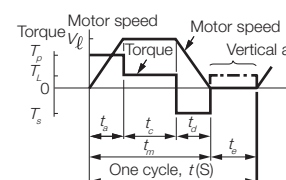
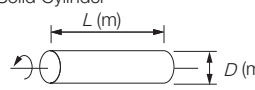
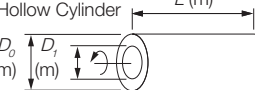
Type of Motion	Rotary Motion	Linear Motion	
		Horizontal Axis	Vertical Axis
Machine Configuration			
	N_ℓ : Load shaft speed (min ⁻¹) V_ℓ : Load speed (m/min) T_ℓ : Load torque calculated at load shaft (N·m) μ : Friction coefficient	P_B : Ball screw lead (m) M : Linear motion section mass (kg) M_C : Counterweight mass (kg)	$1/R$: Gear ratio η : Mechanical efficiency T_{PM} : Servomotor instantaneous maximum torque (N·m)
Speed Diagram			
Travel distance (m)	$R = \frac{V_\ell}{60} \cdot \frac{t_a + 2t_c + t_d}{2} \quad \left(t_a = \text{If...}t_d, R... = \frac{V_\ell}{60} (t_m - t_a) \right)$		
Load Shaft Speed (min ⁻¹)	N_ℓ	$N_\ell = \frac{V_\ell}{P_B}$	
Motor Shaft Speed (min ⁻¹)	$N_M = N_\ell \cdot R$		
Load Torque Calculated at Motor Shaft (N·m)	$T_L = \frac{T_\ell}{R \cdot \eta}$	$T_L = \frac{9.8 \times \mu \cdot M \cdot P_B}{2\pi \cdot R \cdot \eta}$	$T_L = \frac{9.8 \times (M - M_C) P_B}{2\pi \cdot R \cdot \eta}$
Load Moment of Inertia Calculated at Motor Shaft (kg·m ²)	$J_L = J_{L1} + J_{L2} + J_{L3}$		
Linear Motion Section	-	$J_{L1} = M \cdot \left(\frac{P_B}{2\pi R} \right)^2$	$J_{L1} = (M + M_C) \cdot \left(\frac{P_B}{2\pi R} \right)^2$
Rotary Motion Section	<ul style="list-style-type: none"> Solid Cylinder  Hollow Cylinder  	$J_k = \frac{1}{8} M_k \cdot D^2$ OR $J_k = \frac{\pi}{32} \rho \cdot L \cdot D^4$ M_k : Solid cylinder mass (kg) ρ : Density (kg/m ³)...Iron $\rho = 7.87 \times 10^3$ (kg/m ³) ...Aluminum $\rho = 2.70 \times 10^3$ (kg/m ³)	$J_k = \frac{1}{8} M_k (D_o^2 + D_i^2)$ OR $J_k = \frac{\pi}{32} \rho \cdot L (D_o^4 - D_i^4)$
	Moment of Inertia of Rotary Motion Section Calculated at Motor Shaft Rotary motion section at gear input shaft $J_{L2} = J_k$ Rotary motion section at gear output shaft $J_{L3} = \frac{J_k}{R^2}$		
Minimum Starting Time (s)	$t_{am} = \frac{2\pi \cdot N_M (J_M + J_L)}{60 (T_{PM} - T_L)}$		

Continued on next page.

Continued from previous page.

Type of Motion	Rotary Motion	Linear Motion	
		Horizontal Axis	Vertical Axis
Minimum Braking Time (s)		$t_{dm} = \frac{2\pi \cdot N_M (J_M + J_L)}{60 (T_{PM} + T_L)}$	
Load Moving Power (W)		$P_o = \frac{2\pi \cdot N_M \cdot T_L}{60}$	
Load Acceleration Power (W)		$P_a = \left(\frac{2\pi \cdot N_M}{60}\right)^2 \frac{J_L}{t_a}$	$(t_a \geq t_{am})$
Required Starting Torque (N·m)		$T_p = \frac{2\pi \cdot N_M (J_M + J_L)}{60 \times t_a} + T_L$	$(t_a \geq t_{am})$
Required Braking Torque (N·m)		$T_s = \frac{2\pi \cdot N_M (J_M + J_L)}{60 \times t_d} - T_L$	$(t_d \geq t_{dm})$
Effective Torque Value (N·m)		$T_{rms} = \sqrt{\frac{T_p^2 \cdot t_a + T_L^2 \cdot t_c + T_s^2 \cdot t_d}{t}}$	$T_{rms} = \sqrt{\frac{T_p^2 \cdot t_a + T_L^2 (t_c + t_d) + T_s^2 \cdot t_d}{t}}$

12.2.2 GD² for Simple Diagrams

When Rotary Shaft Is Aligned with Center Line of Cylinder	Solid cylinder ($D^2 = D_o^2/2$) (OR $GD^2 = 125\pi \rho L D^4$ ρ : Density (g/cm ³)...Copper: 7.866 L : Length (m) D : Diameter (m))		Hollow cylinder $D^2 = (D_o^2 + D_i^2)/2$ (OR $GD^2 = 125\pi \rho L (D_o^4 + D_i^4)$ ρ : Density (g/cm ³) L : Length (m) D_o, D_i : Diameter (m))	
	Rectangular solid $D^2 = (b^2 + c^2)/3$		Cylindrical body $D^2 = L^2/3 + D_o^2/4$	
When Rotary Shaft Runs Through Gravitational Center	Sphere $D^2 = \frac{2}{5} D_o^2$		Hollow sphere $D^2 = \frac{2}{5} \cdot \frac{D_o^5 - D_i^3}{D_o^3 - D_i^3}$	
	Cone $D^2 = \frac{3}{10} D_o^2$		Wheel $D^2 = D_o^2 + \frac{3}{4} D_i^2$	
When Rotary Shaft Is on One End	Rectangular solid $D^2 = (4b^2 + C^2)/3$		Cylindrical body $D^2 = \frac{4}{3} L^2 + \frac{D_o^2}{4}$	
When Rotary Shaft Is Outside Rotating Body	Rectangular solid $D^2 = \frac{4b^2 + C^2}{3} + 4(bd + d^2)$		Cylindrical body $D^2 = \frac{4}{3} L^2 + \frac{D_o^2}{4} + 4(dL + d^2)$	

Continued on next page.

Continued from previous page.

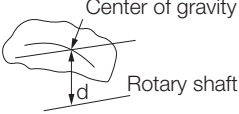
General Formula When Rotary Shaft Is outside Rotating Body	General formula for diameter of rotation when rotary shaft is outside rotating body $D_2^2 = D_1^2 + 4 d^2$ D_1 : Diameter of rotation when shaft that is parallel to rotary shaft and runs through center of gravity virtually operates as a rotary shaft	
--	--	---

Information $GD^2 = \text{Weight} \times (\text{Diameter of rotation})^2$

12.2.3 Conversions between Engineering Units and SI Units

The following table provides the conversion rates between engineering units and SI units for typical physical quantities required for capacity selection.

Quantity	Engineering Unit	SI Unit	Conversion Factor
Force or load	kgf	N	1 kgf = 9.80665 N
Weight	kgf	–	The numerical values are the same for mass in the traditional unit and the SI unit. (The mass SI unit Wkg is used for objects in the Wkgf traditional unit.)
Mass	kgf·s ² /m	kg	
Torque	kgf·m	N·m	1 kgf·m = 9.80665 N·m
Inertia (moment of inertia)	gf·cm·s ²	kg·m ²	1 gf·cm·s ² = 0.980665 × 10 ⁻⁴ kg·m ²
GD ²	kgf·m ²	kg·m ²	Relationship between GD ² (kgf·m ²) and moment of inertia J (kg·m ²) $J = \frac{GD^2}{4}$

12.2.4 Application Examples by Type of Application

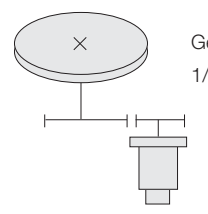
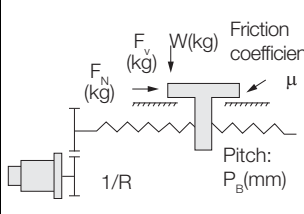
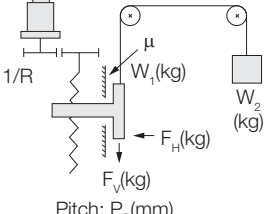
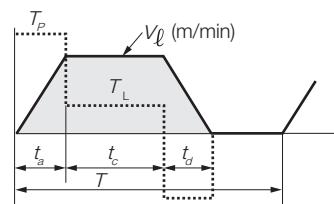
Machine Configuration		Rotating Body	Horizontal Ball Screw	Vertical Ball Screw
				
Load Speed, N_l (min ⁻¹)		N_l	Load speed (m/min) $\frac{1000 \times V_l}{P_B}$	Load speed (m/min) $\frac{1000 \times V_l}{P_B}$
Speed Calculated at Motor Shaft, N_M (min ⁻¹)		$R \times N_l$	$R \times N_l$	$R \times N_l$
Linear Motion Section, GD_2 (kg·m ²)	GD^2_l Calculated at Load Shaft	-	$W \cdot \left(\frac{P_B}{1000\pi}\right)^2$	$W \cdot \left(\frac{P_B}{1000\pi}\right)^2$ [However, $W=W_1+W_2$]
	GD^2_L Calculated at Motor Shaft	$GD^2_L \times \left(\frac{1}{R}\right)^2$	$GD^2_L \times \left(\frac{1}{R}\right)^2$ (OR $W \cdot \left(\frac{V_l}{\pi \cdot N_M}\right)^2$)	$GD^2_L \times \left(\frac{1}{R}\right)^2$ (OR $W \cdot \left(\frac{V_l}{\pi \cdot N_M}\right)^2$) [However, $W=W_1+W_2$]
Load Torque (kg·m)	T_l Calculated at Load Shaft	T_l	$\{\mu \cdot (W + F_v) + F_H\} \cdot \frac{P_B}{2000\pi}$	$\{\mu \cdot F_H + W_1 - W_2 + F_v\} \cdot \frac{P_B}{2000\pi}$
	T_L Calculated at Motor Shaft	$T_l \times \frac{1}{R} \times \frac{1}{\eta}$ Mechanical efficiency	$T_l \times \frac{1}{R} \times \frac{1}{\eta}$ Mechanical efficiency (OR $\frac{\{\mu \cdot (W + F_v) + F_H\} \cdot V_l}{2\pi \cdot N_M \cdot \eta}$)	$T_l \times \frac{1}{R} \times \frac{1}{\eta}$ Mechanical efficiency (OR $\frac{\{\mu \cdot F_H + W_1 - W_2 + F_v\} \cdot V_l}{2\pi \cdot N_M \cdot \eta}$)
Load Moving Power, P_O (kW)		$\frac{T_l \cdot N_l}{973 \times \eta}$	$\frac{\{\mu \cdot (W + F_v) + F_H\} \cdot V_l}{6120 \times \eta}$	$\frac{\{\mu \cdot F_H + W_1 - W_2 + F_v\} \cdot V_l}{6120 \times \eta}$
Load Acceleration Power		$\frac{GD^2_l \cdot N_l^2}{365 \times 10^3 \times t_a}$ Acceleration time (s)	$\frac{GD^2_l \cdot N_l^2}{365 \times 10^3 \times t_a}$ Acceleration time (s)	$\frac{GD^2_l \cdot N_l^2}{365 \times 10^3 \times t_a}$ Acceleration time (s)
Starting Torque, T_P (kg·m) Deceleration Torque, T_S (kg·m) Effective Torque Value, T_{rms} (kg·m)			$T_P = \frac{(GD_M^2 + GD_L^2) \cdot N_M}{375 \cdot t_a} + T_L$ $T_S = \frac{(GD_M^2 + GD_L^2) \cdot N_M}{375 \cdot t_d} - T_L$ $T_{rms} = \sqrt{\frac{T_P^2 \cdot t_a + T_L^2 \cdot t_c + T_S^2 \cdot t_d}{T}}$ <p>(When a load torque is applied while stopped for a vertical ball screw:</p> $T_{rms} = \sqrt{\frac{T_P^2 \cdot t_a + T_L^2 \cdot (T - t_a - t_d) + T_S^2 \cdot t_d}{T}}$	
System Remarks		-	<ul style="list-style-type: none"> The gear backlash is a problem. Suitable for applications for which increasing system speed is not required. A large torque can be generated by a small motor. 	<ul style="list-style-type: none"> Falling when $W_1 \neq W_2$ Brake timing

Continued on next page.

Continued from previous page.

Machine Configuration		Roll Feeder	Rack and Pinion
Load Speed, N_ℓ (min^{-1})	$\frac{1000 \times V_\ell}{P_B}$ <p>[However, $P_B = \pi \cdot d_p$]</p>	$\frac{1000 \times V_\ell}{P_B}$ <p>[However, $P_B = \pi \cdot d_p$ OR $P_B = Z_p \cdot L_p$]</p>	
Speed Calculated at Motor Shaft, N_M (min^{-1})	$R \times N_\ell$	$R \times N_\ell$	
Linear Motion Section, GD_2 ($\text{kg} \cdot \text{m}^2$)	GD_ℓ^2 Calculated at Load Shaft	$W \cdot \left(\frac{d_p}{1000}\right)^2$	$W \cdot \left(\frac{d_p}{1000}\right)^2$
	GD_L^2 Calculated at Motor Shaft	$GD_L^2 \times \left(\frac{1}{R}\right)^2$ [OR $W \cdot \left(\frac{V_\ell}{\pi \cdot N_M}\right)^2$]	$GD_L^2 \times \left(\frac{1}{R}\right)^2$ [OR $W \cdot \left(\frac{V_\ell}{\pi \cdot N_M}\right)^2$]
Load Torque ($\text{kg} \cdot \text{m}$)	T_ℓ Calculated at Load Shaft	$(F_t + \mu_1 W + \mu_2 N) \cdot \frac{d_p}{2000}$	$\{\mu \cdot (W + F_v) + F_H\} \cdot \frac{d_p}{2000}$
	T_L Calculated at Motor Shaft	$T_\ell \times \frac{1}{R} \times \frac{1}{\eta}$ ← Mechanical efficiency [OR $\frac{(F_t + \mu_1 W + \mu_2 N) \cdot V_\ell}{2\pi \cdot N_M \cdot \eta}$]	$T_\ell \times \frac{1}{R} \times \frac{1}{\eta}$ ← Mechanical efficiency [OR $\frac{\{\mu \cdot (W + F_v) + F_H\} \cdot V_\ell}{2\pi \cdot N_M \cdot \eta}$]
Load Moving Power, P_O (kW)	$\frac{(F_t + \mu_1 W + \mu_2 N) \cdot V_\ell}{6120 \times \eta}$	$\frac{\{\mu \cdot (W + F_v) + F_H\} \cdot V_\ell}{6120 \times \eta}$	
Load Acceleration Power	$\frac{GD_\ell^2 \cdot N_\ell^2}{365 \times 10^3 \times t_a}$ Acceleration time (s)	$\frac{GD_\ell^2 \cdot N_\ell^2}{365 \times 10^3 \times t_a}$ Acceleration time (s)	
Starting Torque, T_P ($\text{kg} \cdot \text{m}$) Deceleration Torque, T_S ($\text{kg} \cdot \text{m}$) Effective Torque Value, T_{rms} ($\text{kg} \cdot \text{m}$)		$T_P = \frac{(GD_M^2 + GD_L^2) \cdot N_M}{375 \cdot t_a} + T_L$ $T_S = \frac{(GD_M^2 + GD_L^2) \cdot N_M}{375 \cdot t_d} - T_L$ $T_{rms} = \sqrt{\frac{T_P^2 \cdot t_a + T_L^2 \cdot t_c + T_S^2 \cdot t_d}{T}}$ <p>[When a load torque is applied while stopped for a vertical ball screw: $T_{rms} = \sqrt{\frac{T_P^2 \cdot t_a + T_L^2 \cdot (T - t_a - t_d) + T_S^2 \cdot t_d}{T}}$]</p>	
System Remarks	<ul style="list-style-type: none"> Feeding of coiled and sheet materials Roller slipping affects accuracy. A measuring roller pulse generator may also be installed separately. 	<ul style="list-style-type: none"> Can be used for positioning with long travel distances. A separate pulse generator is often installed. 	

Continued on next page.

Continued from previous page.

Machine Configuration		Chains and Timing Belts	Dollies
Load Speed, N_ℓ (min^{-1})	Load speed (m/min)		Load speed (m/min)
	$\frac{1000 \times V_\ell}{P_B}$ <p>[However, $P_B = \pi \cdot d_p$ OR $P_B = Z_p \cdot L_p$]</p>	$\frac{1000 \times V_\ell}{P_B}$ <p>[However, $P_B = \pi \cdot d_p$]</p>	
Speed Calculated at Motor Shaft, N_M (min^{-1})		$R \times N_\ell$	$R \times N_\ell$
Linear Motion Section, GD_2 ($\text{kg} \cdot \text{m}^2$)	GD_2^ℓ Calculated at Load Shaft		$W \cdot \left(\frac{d_p}{1000}\right)^2$
	GD_2^L Calculated at Motor Shaft		$GD_2^L \times \left(\frac{1}{R}\right)^2$ [OR $W \cdot \left(\frac{V_\ell}{\pi \cdot N_M}\right)^2$]
Load Torque ($\text{kg} \cdot \text{m}$)	T_ℓ Calculated at Load Shaft		$\{\mu \cdot (W + F_v) + F_H\} \cdot \frac{d_p}{2000}$
	T_L Calculated at Motor Shaft		$T_\ell \times \frac{1}{R} \times \frac{1}{\eta}$ ← efficiency [OR $\frac{\{\mu \cdot (W + F_v) + F_H\} \cdot V_\ell}{2\pi \cdot N_M \cdot \eta}$]
Load Moving Power, P_O (kW)		$\frac{\{\mu \cdot (W + F_v) + F_H\} \cdot V_\ell}{6120 \times \eta}$	$\frac{C \cdot W \cdot V_\ell}{6120 \times 10^3 \times \eta}$
Load Acceleration Power		$\frac{GD^2 \ell \cdot N_\ell^2}{365 \times 10^3 \times t_a}$ Acceleration time (s)	$\frac{GD^2 \ell \cdot N_\ell^2}{365 \times 10^3 \times t_a}$ Acceleration time (s)
Starting Torque, T_P ($\text{kg} \cdot \text{m}$) Deceleration Torque, T_S ($\text{kg} \cdot \text{m}$) Effective Torque Value, T_{rms} ($\text{kg} \cdot \text{m}$)			$T_P = \frac{(GD_M^2 + GD_L^2) \cdot N_M}{375 \cdot t_a} + T_L$ $T_S = \frac{(GD_M^2 + GD_L^2) \cdot N_M}{375 \cdot t_d} - T_L$ $T_{rms} = \sqrt{\frac{T_P^2 \cdot t_a + T_L^2 \cdot t_c + T_S^2 \cdot t_d}{T}}$ <p>[When a load torque is applied while stopped for a vertical ball screw:</p> $T_{rms} = \sqrt{\frac{T_P^2 \cdot t_a + T_L^2 \cdot (T - t_a - t_d) + T_S^2 \cdot t_d}{T}}$ <p>]</p>
System Remarks		<ul style="list-style-type: none"> Positioning of conveyors Chain looseness, movement, and pitch error are problems (not suitable for frequent use). Radial load for overtightened belt chains 	<ul style="list-style-type: none"> Dolly slipping

Revision History

The revision dates and numbers of the revised manuals are given on the bottom of the back cover.

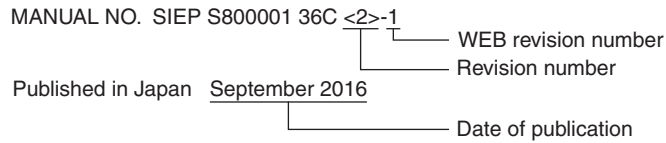

Date of Publication	Rev. No.	WEB Rev. No.	Section	Revised Contents
December 2018	<7>	0	Back cover	Revision: Address
October 2018	<6>	0	–	Same changes as for SIEP S800001 36E<5>-1 for the Web
October 2018	<5>	1	Preface	Partly revised.
			5.3.2	Revision: Dimension KL1 of SGM7A-15, -20, -25
May 2018		0	All chapters	Addition: Information on SGM7M Servomotors Partly revised.
November 2017	<4>	0	Back cover	Revision: Address
December 2016	<3>	0	–	Same changes as for SIEP S800001 36C<2>-1 for the Web
			Preface	Partly revised.
			All chapters	Addition: Information on models with 24-bit batteryless absolute encoders (model numbers: SGM7J-□□A6A, SGM7A-□□A6A, SGM7P-□□A6A, and SGM7G-□□A6A) Addition: Information on Σ-7C SERVOPACKs (model numbers: SGD7C-□□□AMAA)
			Back cover	Revision: Address
September 2016	<2>	1	Preface	Revision: Safety Standards
			9.5.2	Revision: Tightening torque for SGM7P Servomotors
June 2016		0	All chapters	Partly revised.
			Preface	Revision: UL standards and European directives
			Chapters 1 and 9	Addition: Information on SGMMV Servomotors
			Chapter 3	Newly added.
			Chapters 6 and 7	Order of chapters changed.
			Back cover	Revision: Address
April 2015	<1>	0	All chapters	Partly revised.
			Preface	Additions: Troubleshooting precautions Revision: Compliance with UL Standards, EU Directives, and Other Safety Standards
			Chapters 1, 4, 8	Addition: Information on SGM7A-40A, -50A, and -70A Servomotors
			Chapters 1, 5, 8	Additions: Information on SGM7G-30A, -44A, -55A, -75A, -1AA, and -1EA Servomotors
			Chapters 1, 8	Addition: Information on SGM7P Servomotors
			1.2	Revision: Nameplates
			1.1.3, 4.3, 8.1.2	Revision: For changes to SGM7A Servomotor specifications
			3.2, 4.2, 5.2, 6.2	Addition: Precautions for derating
			5.2.1, 6.2.1	Revision: Thermal class
			Chapter 6	Newly added.
April 2014	–	–	–	First edition

Σ-7-Series AC Servo Drive Rotary Servomotor Product Manual

IRUMA BUSINESS CENTER (SOLUTION CENTER)

480, Kamifujisawa, Iruma, Saitama, 358-8555, Japan
Phone: +81-4-2962-5151 Fax: +81-4-2962-6138
<http://www.yaskawa.co.jp>

YASKAWA AMERICA, INC.

2121, Norman Drive South, Waukegan, IL 60085, U.S.A.
Phone: +1-800-YASKAWA (927-5292) or +1-847-887-7000 Fax: +1-847-887-7310
<http://www.yaskawa.com>

YASKAWA ELÉTRICO DO BRASIL LTDA.

777, Avenida Piraporinha, Diadema, São Paulo, 09950-000, Brasil
Phone: +55-11-3585-1100 Fax: +55-11-3585-1187
<http://www.yaskawa.com.br>

YASKAWA EUROPE GmbH

Hauptstraße 185, 65760 Eschborn, Germany
Phone: +49-6196-569-300 Fax: +49-6196-569-398
<http://www.yaskawa.eu.com> E-mail: info@yaskawa.eu.com

YASKAWA ELECTRIC KOREA CORPORATION

35F, Three IFC, 10 Gukjegeumyung-ro, Yeongdeungpo-gu, Seoul, 07326, Korea
Phone: +82-2-784-7844 Fax: +82-2-784-8495
<http://www.yaskawa.co.kr>

YASKAWA ASIA PACIFIC PTE. LTD.

30A, Kallang Place, #06-01, 339213, Singapore
Phone: +65-6282-3003 Fax: +65-6289-3003
<http://www.yaskawa.com.sg>

YASKAWA ELECTRIC (THAILAND) CO., LTD.

59, 1st-5th Floor, Flourish Building, Soi Ratchadapisek 18, Ratchadapisek Road, Huaykwang, Bangkok, 10310, Thailand
Phone: +66-2-017-0099 Fax: +66-2-017-0799
<http://www.yaskawa.co.th>

YASKAWA ELECTRIC (CHINA) CO., LTD.

22F, Link Square 1, No.222, Hubin Road, Shanghai, 200021, China
Phone: +86-21-5385-2200 Fax: +86-21-5385-3299
<http://www.yaskawa.com.cn>

YASKAWA ELECTRIC (CHINA) CO., LTD. BEIJING OFFICE

Room 1011, Tower W3 Oriental Plaza, No.1, East Chang An Ave.,
Dong Cheng District, Beijing, 100738, China
Phone: +86-10-8518-4086 Fax: +86-10-8518-4082

YASKAWA ELECTRIC TAIWAN CORPORATION

12F, No. 207, Sec. 3, Beishin Rd., Shindian Dist., New Taipei City 23143, Taiwan
Phone: +886-2-8913-1333 Fax: +886-2-8913-1513 or +886-2-8913-1519
<http://www.yaskawa.com.tw>

YASKAWA**YASKAWA ELECTRIC CORPORATION**

In the event that the end user of this product is to be the military and said product is to be employed in any weapons systems or the manufacture thereof, the export will fall under the relevant regulations as stipulated in the Foreign Exchange and Foreign Trade Regulations. Therefore, be sure to follow all procedures and submit all relevant documentation according to any and all rules, regulations and laws that may apply.

Specifications are subject to change without notice for ongoing product modifications and improvements.

© 2014 YASKAWA ELECTRIC CORPORATION

MANUAL NO. SIEP S800001 36F <7>-0

Published in Japan December 2018

18-10-15

Original instructions