

# Digital Controller E5AR E5ER

## User's Manual

# OMRON

**OMRON Corporation**  
Industrial Automation Company

**Control Devices Division H.Q.**  
**Analog Controller Division**  
Shiokoji Horikawa, Shimogyo-ku,  
Kyoto, 600-8530 Japan  
Tel: (81)75-344-7080/Fax: (81)75-344-7189

**Regional Headquarters**

**OMRON EUROPE B.V.**  
Wegalaan 67-69, NL-2132 JD Hoofddorp  
The Netherlands  
Tel: (31)2356-81-300/Fax: (31)2356-81-388

**OMRON ELECTRONICS LLC**  
1 East Commerce Drive, Schaumburg, IL 60173  
U.S.A.  
Tel: (1)847-843-7900/Fax: (1)847-843-8568

**OMRON ASIA PACIFIC PTE. LTD.**  
83 Clemenceau Avenue,  
#11-01, UE Square,  
239920 Singapore  
Tel: (65)6835-3011/Fax: (65)6835-2711

**OMRON (CHINA) CO., LTD.**  
Room 2211, Bank of China Tower,  
200 Yin Cheng Road (M),  
Shanghai, 200120 China  
Tel: (86)21-5037-2222/Fax: (86)21-5037-2200

**Authorized Distributor:**

# Introduction

OMRON products are manufactured for use according to proper procedures by a qualified operator and only for the purposes described in this manual.

This manual describes the functions, performance, and application methods needed for optimum use of the E5AR/E5ER Digital Controllers.

Please observe the following items when using the E5AR/E5ER Digital Controllers.

- This product is designed for use by qualified personnel with a knowledge of electrical systems.
- Read this manual carefully and make sure you understand it well to ensure that you are using the E5AR/E5ER Digital Controllers correctly.
- Keep this manual in a safe location so that it is available for reference when required.

## Precaution in using the product

Before using the Controller under the following conditions, make sure that the ratings and performance characteristics of the Controller are sufficient for the systems, machines, and equipment, and be sure to provide the systems, machines, and equipment with double safety mechanisms, and also consult your OMRON representative.

- Using the Controller under conditions which are not described in the manual
- Applying the Controller to nuclear control systems, railroad systems, aviation systems, vehicles, combustion systems, medical equipment, amusement machines, safety equipment, and other systems, machines, and equipment
- Applying the Controller to systems, machines, and equipment that may have a serious influence on lives and property if used improperly, and especially require safety

### Notice

- (1) All rights reserved. No part of this manual may be reprinted or copied without the prior written permission of OMRON.
- (2) The specifications and other information in this manual are subject to change without notice for purposes of improvement.
- (3) Considerable care has been taken in the preparation of this manual; however, OMRON assumes no responsibility or liability for any errors or inaccuracies that may appear. In the event that a problem is discovered, please contact one of the Omron offices or agents listed at the end of the manual, and provide the catalogue number shown on the cover of the manual.

## Read and Understand this Manual

Please read and understand this manual before using the product. Please consult your OMRON representative if you have any questions or comments.

## Warranty and Limitations of Liability

### WARRANTY

OMRON's exclusive warranty is that the products are free from defects in materials and workmanship for a period of one year (or other period if specified) from date of sale by OMRON.

OMRON MAKES NO WARRANTY OR REPRESENTATION, EXPRESS OR IMPLIED, REGARDING NON-INFRINGEMENT, MERCHANTABILITY, OR FITNESS FOR PARTICULAR PURPOSE OF THE PRODUCTS. ANY BUYER OR USER ACKNOWLEDGES THAT THE BUYER OR USER ALONE HAS DETERMINED THAT THE PRODUCTS WILL SUITABLY MEET THE REQUIREMENTS OF THEIR INTENDED USE. OMRON DISCLAIMS ALL OTHER WARRANTIES, EXPRESS OR IMPLIED.

### LIMITATIONS OF LIABILITY

OMRON SHALL NOT BE RESPONSIBLE FOR SPECIAL, INDIRECT, OR CONSEQUENTIAL DAMAGES, LOSS OF PROFITS OR COMMERCIAL LOSS IN ANY WAY CONNECTED WITH THE PRODUCTS, WHETHER SUCH CLAIM IS BASED ON CONTRACT, WARRANTY, NEGLIGENCE, OR STRICT LIABILITY.

In no event shall the responsibility of OMRON for any act exceed the individual price of the product on which liability is asserted.

IN NO EVENT SHALL OMRON BE RESPONSIBLE FOR WARRANTY, REPAIR, OR OTHER CLAIMS REGARDING THE PRODUCTS UNLESS OMRON'S ANALYSIS CONFIRMS THAT THE PRODUCTS WERE PROPERLY HANDLED, STORED, INSTALLED, AND MAINTAINED AND NOT SUBJECT TO CONTAMINATION, ABUSE, MISUSE, OR INAPPROPRIATE MODIFICATION OR REPAIR.

## Application Considerations

### SUITABILITY FOR USE

OMRON shall not be responsible for conformity with any standards, codes, or regulations that apply to the combination of products in the customer's application or use of the products.

At the customer's request, OMRON will provide applicable third party certification documents identifying ratings and limitations of use that apply to the products. This information by itself is not sufficient for a complete determination of the suitability of the products in combination with the end product, machine, system, or other application or use.

The following are some examples of applications for which particular attention must be given. This is not intended to be an exhaustive list of all possible uses of the products, nor is it intended to imply that the uses listed may be suitable for the products.

- Outdoor use, uses involving potential chemical contamination or electrical interference, or conditions or uses not described in this manual.
- Nuclear energy control systems, combustion systems, railroad systems, aviation systems, medical equipment, amusement machines, vehicles, safety equipment, and installations subject to separate industry or government regulations.
- Systems, machines, and equipment that could present a risk to life or property.

Please know and observe all prohibitions of use applicable to the products.

NEVER USE THE PRODUCTS FOR AN APPLICATION INVOLVING SERIOUS RISK TO LIFE OR PROPERTY WITHOUT ENSURING THAT THE SYSTEM AS A WHOLE HAS BEEN DESIGNED TO ADDRESS THE RISKS, AND THAT THE OMRON PRODUCTS ARE PROPERLY RATED AND INSTALLED FOR THE INTENDED USE WITHIN THE OVERALL EQUIPMENT OR SYSTEM.

### PROGRAMMABLE PRODUCTS

OMRON shall not be responsible for the user's programming of a programmable product, or any consequence thereof.

## Disclaimers

### **CHANGE IN SPECIFICATIONS**

Product specifications and accessories may be changed at any time based on improvements and other reasons.

It is our practice to change model numbers when published ratings or features are changed, or when significant construction changes are made. However, some specifications of the products may be changed without any notice. When in doubt, special model numbers may be assigned to fix or establish key specifications for your application on your request. Please consult with your OMRON representative at any time to confirm actual specifications of purchased products.

### **DIMENSIONS AND WEIGHTS**

Dimensions and weights are nominal and are not to be used for manufacturing purposes, even when tolerances are shown.

### **PERFORMANCE DATA**

Performance data given in this manual is provided as a guide for the user in determining suitability and does not constitute a warranty. It may represent the result of OMRON's test conditions, and the users must correlate it to actual application requirements. Actual performance is subject to the OMRON Warranty and Limitations of Liability.

### **ERRORS AND OMISSIONS**

The information in this document has been carefully checked and is believed to be accurate; however, no responsibility is assumed for clerical, typographical, or proofreading errors, or omissions.

## Precautions

### Definition of Safety Notices and Information





The following notation is used in this manual to provide precautions required to ensure safe usage of the product.

The safety precautions that are provided are extremely important to safety. Always read and heed the information provided in all safety precautions.





The following notation is used.

|  |  |
|--|--|
|  <b>Caution</b> | Indicates a potentially hazardous situation which, if not avoided, may result in minor or moderate injury or in property damage. |
|--|--|

### ● Symbols

| Symbol                   |   | Meaning   |
|--------------------------|---|---|
| <b>Caution</b>           |  | <b>General Caution</b><br>Indicates non-specific general cautions, warnings and dangers.              |
|                          |  | <b>Electrical Shock Caution</b><br>Indicates possibility of electric shock under specific conditions. |
| <b>Prohibition</b>       |  | <b>General Prohibition</b><br>Indicates non-specific general prohibitions.                            |
| <b>Mandatory Caution</b> |  | <b>General Caution</b><br>Indicates non-specific general cautions, warnings, and dangers.             |

● Precautions

|  <b>CAUTION</b>  |   |
|---|---|
| Do not touch any of the terminals or terminal blocks while power is being supplied. Doing so may occasionally result in minor injury due to electric shock.   |    |
| Do not touch the terminals, or electronic components or patterns on the PCB within 1 minute after turning OFF the power. Doing so may occasionally result in minor injury due to electric shock.  |   |
| Do not allow pieces of metal, wire clippings, or fine metallic shavings or filings from installation to enter the product. Doing so may occasionally result in electric shock, fire, or malfunction.  |    |
| Do not use the product in locations where flammable or explosive gases are present. Doing so may occasionally result in minor or moderate explosion, causing minor or moderate injury, or property damage.  |   |
| Do not attempt to disassemble, repair, or modify the product. Doing so may occasionally result in minor injury due to electric shock.   |   |
| Tighten the screws on the terminal block and the connector locking screws securely using a tightening torque within the following ranges. Loose screws may occasionally cause fire, resulting in minor or moderate injury, or damage to the equipment.<br>Terminal block screws: 0.40 to 0.56 N·m   |  |
| Perform correct setting of the product according to the application. Failure to do so may occasionally cause unexpected operation, resulting in minor or moderate injury, or damage to the equipment.   |   |
| Ensure safety in the event of product failure by taking safety measures, such as installing a separate overheating prevention alarm system. Product failure may occasionally prevent control, or operation of alarm outputs, resulting in damage to the connected facilities and equipment.   |   |
| Do not use the equipment for measurements within Measurement Categories II, III, or IV (according to IEC61010-1). Doing so may occasionally cause unexpected operation, resulting in minor or moderate injury, or damage to the equipment. Use the equipment for measurements only within the Measurement Category for which the product is designed. |   |
| The service life of the output relays depends on the switching capacity and switching conditions. Consider the actual application conditions and use the product within the rated load and electrical service life. Using the product beyond its service life may occasionally result in contact welding or burning.                                  |  |

## Precautions for Safe Use

- (1) Use and store the product within the specified ambient temperature and humidity ranges. If several products are mounted side-by-side or arranged in a vertical line, the heat dissipation will cause the internal temperature of the products to rise, shortening the service life. If necessary, cool the products using a fan or other cooling method.
- (2) Provide sufficient space around the product for heat dissipation. Do not block the vents on the product.
- (3) Use the product within the noted supply voltage and rated load.
- (4) Be sure to confirm the name and polarity for each terminal before wiring the terminal block and connectors.
- (5) Do not connect anything to unused terminals.
- (6) Use the specified size of crimp terminals (M3, width: 5.8 mm max.) for wiring the terminal block.
- (7) To connect bare wires to the terminal block, use AWG22 to AWG14 (cross-sectional area: 0.326 to 2.081 mm<sup>2</sup>) to wire the power supply terminals and AWG28 to AWG16 (cross-sectional area: 0.081 to 1.309 mm<sup>2</sup>) for other terminals. (Length of exposed wire: 6 to 8 mm)
- (8) Ensure that the rated voltage is achieved no longer than 2 s after turning the power ON.
- (9) Turn OFF the power first before drawing out the product. Never touch the terminals or the electronic components, or subject them to physical shock. When inserting the product, do not allow the electronic components to contact the case.
- (10) Do not remove the inner circuit board.
- (11) Output turns OFF when shifting to the initial setting level in certain modes. Take this into consideration when setting up the control system.
- (12) Allow the product to warm up for at least 30 minutes after the power is turned ON.
- (13) Install surge absorbers or noise filters in devices near the product that generate noise (in particular, devices with an inductance component, such as motors, transformers, solenoids, and magnetic coils). If a noise filter is used for the power supply, check the voltage and current, and install the noise filter as close as possible to the product. Separate the product as far as possible from devices generating strong high-frequency noise (e.g., high-frequency welders and high-frequency sewing machines) or surges. Do not tie noise filter input/output wires together.
- (14) Keep the wiring for the product's terminal block and connector separate from high-voltage, high-current power lines to prevent inductive noise. Do not run the wiring parallel to or in the same cable as power lines. The influence of noise can also be reduced by using separate wiring ducts or shield lines.
- (15) Install an external switch or circuit breaker and label them clearly so that the operator can quickly turn OFF the power.
- (16) Do not use the product in the following locations:
  - Locations where dust or corrosive gases (in particular, sulfuric or ammonia gas) are present.
  - Locations where icing or condensation may occur.
  - Locations exposed to direct sunlight.
  - Locations subject to excessive shock or vibration.
  - Locations where the product may come into contact with water or oil.
  - Locations subject to direct radiant heat from heating equipment.
  - Locations subject to extreme temperature changes.
- (17) Cleaning: Do not use thinners. Use commercially available alcohol.

## Precautions for Correct Use

### ● Service Life

Use the product within the following temperature and humidity ranges:

Temperature: -10 to 55°C (no icing or condensation)

Humidity: 25% to 85%

When the product is installed inside a control panel, make sure that the temperature around the product, not the temperature around the control panel, does not exceed 55°C.

The service life of this product and similar electronic devices is determined not only by the number of switching operations of relays but also by the service life of internal electronic components. Component service life is affected by the ambient temperature: the higher the temperature becomes, the shorter the service life becomes and, the lower the temperature becomes, the longer the service life becomes. Therefore, the service life can be extended by lowering the temperature of the product.

Be sure to install the product according to the specified conditions. Otherwise, the heat generated by the product will cause the internal temperature to rise, shortening the service life. If necessary, cool the product using fans or other means of air ventilation.

When providing forced cooling, however, be careful not to cool down the terminals sections alone to avoid measurement errors.

### ● Noise Countermeasures

To prevent inductive noise, separate the wiring for the product's terminal block and connector from high-voltage, high-current power lines. Do not run the wiring parallel to or in the same cable as power lines. The influence of noise can also be reduced by using separate wiring ducts or shield lines.

Install surge absorbers or noise filters in devices near the product that generate noise (in particular, devices with an inductance component, such as motors, transformers, solenoids, and magnetic coils).

If a noise filter is used for the power supply, check the voltage and current, and install the noise filter as close as possible to the product.

Separate the product as far as possible from devices generating strong high-frequency noise (e.g., high-frequency welders and high-frequency sewing machines) or surges.

### ● Measurement Accuracy

When extending the thermocouple lead wire, be sure to use a compensating wire that matches the thermocouple type.

When extending the lead wire of the platinum resistance thermometer, be sure to use wires that have low resistance, and make sure that the resistances of the three lead wires are the same.

If the measurement accuracy is low, check whether the input shift is set correctly.

### ● Waterproofing

The degree of protection is as shown below.

|             |      |
|-------------|------|
| Front panel | IP66 |
| Rear case   | IP20 |
| Terminals   | IP00 |



# About this Manual

## ● How to use the manual

| Purpose                            | Related section  | Contents  |
|------------------------------------|--|---|
| General explanation of the E5AR/ER | Section 1 Overview   | Explains the features, part names, and main functions of the E5AR/ER.                                     |
| Setup                              | Section 2 Preparations<br>Section 3 Typical Control Examples             | Explains how to set up the E5AR/ER for operation (mounting, wiring, initial settings).                    |
| Basic operation of the E5AR/ER     | Section 4 Settings Required for Basic Control<br>Section 8 Setting Data  | Explains the basic functions of the E5AR/ER.  |
| Advanced functions of the E5AR/ER  | Section 5 Functions and Operations<br>Section 8 Setting Data             | Explains how to use the customized functions (scaling, SP ramp, etc.) to get the most out of the E5AR/ER. |
| Communication functions            | Section 6 Communication (CompoWay/F)<br>Section 7 Communication (Modbus) | Explains how to use communication-based functions.  |
| User calibration                   | Section 9 User Calibration   | Explains calibration procedures that can be performed by the user.  |
| Troubleshooting                    | Section 10 Troubleshooting   | Explains what to do when you encounter a problem.   |
| Appendix                           |  | Product specifications. List of settings.<br>Can be used to make a copy of your settings.                 |

For details on using DeviceNet communications functions, refer to the *E5AR/E5ER Digital Controller DeviceNet Communications User's Manual (H124)*.

## ● Special markings

### (1) Important

This appears in cases where incorrect settings or operation will prevent a function from achieving the expected result.



Set the input type before setting the scaling value.  
If the input type is changed after setting the scaling value, the scaling value will be automatically initialized.

### (2) Hint

This gives useful hints, advice, and other supplemental information.



The rise and fall values of the SP ramp of the E5AR/ER can be set separately.

(3) Marks used to indicate "Function," "Setting," "Monitor," and "Reference" in "Setting Data" in Section 8 are explained in Section 8.

## ● Abbreviations

Abbreviations used in the setting data, illustrations, and text are as follows.

| Abbreviation | Meaning                      |
|--------------|------------------------------|
| PV           | Present value                |
| SP           | Set point                    |
| SV           | Set value                    |
| AT           | Auto-tuning (A.T)            |
| EU           | Unit of industrial quantity* |
| ch           | Channel                      |

\* Data after scaling is shown in industrial units such as °C, m, and g, and "EU" is used to indicate the minimum increment of such a quantity. For example, the minimum increment of 50.02 m is 0.01 m, and thus 1 EU would be equal to 0.01 m.

## ● Notation used for settings

Letters, numbers and abbreviations in settings that appear in the E5AR/ER display are as follows.

|   |   |   |   |   |   |   |   |   |   |   |   |   |
|---|---|---|---|---|---|---|---|---|---|---|---|---|
| A | B | C | D | E | F | G | H | I | J | K | L | M |
|---|---|---|---|---|---|---|---|---|---|---|---|---|

|   |   |   |   |   |   |   |   |   |   |   |   |   |
|---|---|---|---|---|---|---|---|---|---|---|---|---|
| N | O | P | Q | R | S | T | U | V | W | X | Y | Z |
|---|---|---|---|---|---|---|---|---|---|---|---|---|

|   |   |   |   |   |   |   |   |   |   |                             |
|---|---|---|---|---|---|---|---|---|---|-----------------------------|
| 0 | 1 | 2 | 3 | 4 | 5 | 6 | 7 | 8 | 9 | -1 (Most significant digit) |
|---|---|---|---|---|---|---|---|---|---|-----------------------------|

## ● Revision History

The revision code of this manual is given at the end of the catalog number at the bottom left of the back cover. The following table outlines the changes made to the manual during each revision. Page numbers refer to the previous version.

|          |            |
|----------|------------|
| Cat. No. | Z182-E1-03 |
|----------|------------|

| Revision code | Date          | Pages and changes   |
|---------------|---------------|---|
| 01            | May 2003      | Original production   |
| 02            | February 2004 | <p>The following changes were made. Other changes were also made to improve general quality.</p> <p><b>Introduction:</b> Descriptions mainly on precautionary information updated.</p> <p><b>Page 1-5:</b> "Bar graph" added to the top list.</p> <p><b>Page 1-6:</b> "Function key 1" added to the "Auto/Manual key."</p> <p><b>Page 1-7:</b> Note at the bottom of the page corrected.</p> <p><b>Page 1-8:</b> Event input assignment diagram corrected.</p> <p><b>Page 1-10:</b> Control/transfer output allocation diagram corrected.</p> <p><b>Page 1-12:</b> Item 11 corrected to "Communications method."</p> <p><b>Pages 2-4 to 2-7:</b> Terminal arrangement graphics corrected.</p> <p><b>Page 2-8:</b> Paragraph below the table deleted.</p> <p><b>Page 2-9:</b> Note added below the table.</p> <p><b>Page 2-10:</b> E5ER graphic on the right side deleted and "E5ER" on the left graphic changed to "E5ER-□4□□"</p> <p><b>Page 2-11:</b> "Event inputs 3 to 7" corrected to "event inputs 3 to 6" in two paragraphs under <i>Event inputs (terminals)</i>.</p> <p><b>Page 3-11 (and throughout the manual):</b> "Control initial setting level 2" corrected to "Control initial setting 2 level."</p> <p><b>Page 3-16:</b> The RSP indicator in the graphic under <i>RUN level (Ch 2)</i> corrected to OFF from ON.</p> <p><b>Page 4-7:</b> "PID adjustment level" corrected to "PID setting level."</p> <p><b>Page 4-22:</b> Auxiliary output assignment diagram corrected.</p> <p><b>Page 4-25:</b> Item 8 "Press the level key twice" corrected to "Press the level key three times."</p> <p><b>Page 4-31:</b> Item (1) "About two seconds" corrected to "About four seconds."</p> <p><b>Page 5-9:</b> Monitor and setting range for SP ramp time unit in the top table corrected.</p> <p><b>Page 5-30:</b> "Auto/Manual (Adjustment level)" corrected to "Auto/Manual (RUN level)" under <i>Auto/Manual</i>.</p> <p><b>Page 8-12:</b> DOTC: Disturbance time constant under <i>Adjustment level</i> corrected to "0.01-99.99."</p> <p><b>Pages 8-15, 8-16, 8-19, 8-27, 8-31, and 8-32:</b> "PID Set No." corrected to "PID."</p> <p><b>Page 8-26:</b> The seven segment display (7.LSP) at the right top placed in a white box.</p> <p><b>Page 8-35:</b> Description added to RSPH and RSPL in the bottom graphic.</p> <p><b>Page 8-46:</b> Description under <i>Setting range</i> in the top table corrected.</p> <p><b>Page 8-49:</b> The second "Cascade standard control" in the bottom table corrected to "Cascade heating/cooling control."</p> <p><b>Page 8-51:</b> The default value under <i>straight-line approximation</i> corrected from ON to OFF.</p> <p><b>Page A-2:</b> Note 3 added below the Unit Ratings table.</p> <p><b>Page A-2:</b> "Outflow current: Approx. 7 mA" under <i>Unit ratings</i> corrected to "Short-circuit current: Approx. 4 mA."</p> <p><b>Page A-3:</b> "(±5% FS)± digit or less" under <i>Indication accuracy</i> corrected to "(±5% FS)± 1 digit max."</p> <p><b>Page A-3:</b> "0.2 to 99.9 seconds" under <i>Control period</i> corrected to "0.2 to 99.0 seconds."</p> <p><b>Page A-3:</b> "Acceleration: 10 m/s<sup>2</sup>" under <i>Vibration tolerance</i> corrected to "Acceleration: 20 m/s<sup>2</sup>."</p> <p><b>Page A-19:</b> Description under <i>Setting (monitor) value</i> for 0E0C corrected.</p> <p><b>Page A-20:</b> Description under <i>Setting (monitor) value</i> for 0E20 corrected.</p> <p><b>Page A-22:</b> The second "Cascade standard control" in the table corrected to "Cascade heating/cooling control."</p> <p><b>Page A-30:</b> DOTC: Disturbance time constant under <i>Adjustment level</i> corrected to "0.01-99.99."</p> |
| 02A           | November 2004 | <p>The following changes were made.</p> <p><b>Page A-3:</b> Information was added to the table and accompanying notes.</p>  |

| Revision code | Date     | Pages and changes   |
|---------------|----------|---|
| 03            | May 2005 | <p>The following changes were made.</p> <p><b>Page 4-10:</b> Information added on direct/reverse operation, alarms, input shift, SP ramp, and PID.</p> <p><b>Page 5-6:</b> "0.0000" corrected to "0.000" and "210.0°C" corrected to "190.0°C" in text and graph.</p> <p><b>Pages 5-13 and 8-32:</b> Setting range changed from "10% to 110% of setting range" to "-19999 to 99999" in table, and related note removed.</p> <p><b>Page 5-26:</b> Condition B changed to "At power on" for standby sequence restart.</p> <p><b>Page 8-37:</b> Note added.</p> |



# Contents

|                                 |      |
|---------------------------------|------|
| Introduction                    | I    |
| Precaution in using the product | I    |
| Precautions                     | IV   |
| Precautions for Safe Use        | VI   |
| Precautions for Correct Use     | VII  |
| About this Manual               | VIII |

## Section 1 Overview

|     |   |      |
|-----|---|------|
| 1.1 | Main Features of the E5AR/ER                  | 1-2  |
|     | Inputs  | 1-2  |
|     | Controller                                    | 1-2  |
|     | Outputs                                       | 1-3  |
| 1.2 | Part Names and Functions                      | 1-4  |
|     | Front   | 1-4  |
|     | How to read the display                       | 1-5  |
|     | Explanation of the keys                       | 1-6  |
| 1.3 | Input/output Configuration and Main Functions | 1-7  |
|     | Input/output configuration                    | 1-7  |
|     | Main functions                                | 1-8  |
|     | Explanation of Model Numbers                  | 1-12 |

## Section 2 Preparations

|     |                          |      |
|-----|--------------------------|------|
| 2.1 | Installation             | 2-2  |
|     | Dimensions               | 2-2  |
|     | Installation             | 2-2  |
| 2.2 | How to Use the Terminals | 2-4  |
|     | E5AR                     | 2-4  |
|     | E5ER                     | 2-8  |
|     | Precautions when wiring  | 2-11 |
|     | Wiring                   | 2-11 |

## Section 3 Typical Control Examples

|     |   |      |
|-----|---|------|
| 3.1 | Standard control                                      | 3-2  |
|     | Application   | 3-2  |
|     | Wiring  | 3-2  |
|     | Settings  | 3-3  |
|     | Adjustment  | 3-4  |
| 3.2 | Heating/cooling control of a chemical reaction device | 3-5  |
|     | Application   | 3-5  |
|     | Wiring  | 3-6  |
|     | Settings  | 3-6  |
|     | Adjustment  | 3-7  |
|     | Settings for heating/cooling control                  | 3-8  |
| 3.3 | Position proportional control of a ceramic kiln       | 3-9  |
|     | Application   | 3-9  |
|     | Wiring  | 3-10 |
|     | Settings  | 3-10 |
|     | Adjustment  | 3-11 |
|     | Settings for position proportional control            | 3-12 |

|     |  |      |
|-----|--|------|
| 3.4 | Cascade control of reflow ovens .....  | 3-13 |
|     | Application .....                      | 3-13 |
|     | Wiring .....                           | 3-14 |
|     | Settings .....                         | 3-14 |
|     | Adjustment .....                       | 3-15 |
| 3.5 | Ratio control of dyeing machines ..... | 3-18 |
|     | Application .....                      | 3-18 |
|     | Wiring .....                           | 3-19 |
|     | Settings .....                         | 3-19 |
|     | Adjustment .....                       | 3-21 |

## Section 4 Settings Required for Basic Control

|      |   |      |
|------|---|------|
| 4.1  | Setting levels and key operation .....                    | 4-2  |
| 4.2  | Set values .....  | 4-4  |
| 4.3  | Initial setting examples .....                            | 4-5  |
| 4.4  | Setting the input type .....                              | 4-8  |
|      | Input type .....  | 4-8  |
|      | Scaling .....   | 4-9  |
| 4.5  | Selecting the temperature units .....                     | 4-12 |
| 4.6  | Selecting the control mode .....                          | 4-13 |
| 4.7  | Setting output parameters .....                           | 4-14 |
|      | Control period .....                                      | 4-14 |
|      | Direct operation (cool) / Reverse operation (heat) .....  | 4-14 |
|      | Output type .....   | 4-15 |
|      | Output assignment .....                                   | 4-15 |
| 4.8  | Setting and changing the SP .....                         | 4-17 |
|      | Setting and changing the SP .....                         | 4-17 |
| 4.9  | Performing ON/OFF control .....                           | 4-18 |
|      | ON/OFF Control .....                                      | 4-18 |
|      | Settings .....  | 4-19 |
| 4.10 | Determining the PID constants (AT, manual settings) ..... | 4-20 |
|      | AT (Auto-tuning) .....                                    | 4-20 |
|      | Manual settings .....                                     | 4-22 |
| 4.11 | Using auxiliary output .....                              | 4-23 |
|      | Auxiliary output assignment .....                         | 4-23 |
|      | Alarm types .....   | 4-24 |
|      | Alarm values .....  | 4-25 |
|      | Settings .....  | 4-25 |
| 4.12 | Starting and stopping control .....                       | 4-27 |
|      | Control run / Control stop .....                          | 4-27 |
|      | Settings .....  | 4-28 |
| 4.13 | Performing manual control .....                           | 4-29 |
|      | Manual mode .....   | 4-29 |
| 4.14 | Changing channels .....                                   | 4-31 |
|      | Changing channels .....                                   | 4-31 |
| 4.15 | Operational considerations .....                          | 4-32 |

## Section 5 Functions and Operations

|     |  |     |
|-----|--|-----|
| 5.1 | Input adjustment functions .....           | 5-2 |
|     | Input shift .....                          | 5-2 |
|     | First order lag operation .....            | 5-5 |
|     | Move average .....                         | 5-5 |
|     | Broken-line approximation .....            | 5-6 |
|     | Extraction of square root operations ..... | 5-7 |
|     | Other input adjustment functions .....     | 5-7 |

|     |  |      |
|-----|--|------|
| 5.2 | Control functions .....                          | 5-8  |
|     | SP ramp .....                                    | 5-8  |
|     | Banks .....                                      | 5-9  |
|     | SP limits .....                                  | 5-12 |
|     | PID sets .....                                   | 5-12 |
|     | Disturbance overshoot adjustment .....           | 5-14 |
| 5.3 | Output adjustment functions .....                | 5-16 |
|     | MV limit .....                                   | 5-16 |
|     | MV change rate limit .....                       | 5-17 |
|     | MV at Stop .....                                 | 5-18 |
|     | MV at PV error .....                             | 5-18 |
| 5.4 | Display and key adjustment functions .....       | 5-19 |
|     | Display scan .....                               | 5-19 |
|     | PF settings (function keys) .....                | 5-21 |
|     | Other display and key adjustment functions ..... | 5-23 |
| 5.5 | Protecting settings .....                        | 5-24 |
|     | Protect .....                                    | 5-24 |
| 5.6 | Alarm adjustment functions .....                 | 5-26 |
|     | Alarm hysteresis .....                           | 5-26 |
|     | Standby sequence .....                           | 5-26 |
|     | Alarm latch .....                                | 5-27 |
|     | Close in alarm/Open in alarm .....               | 5-27 |
| 5.7 | Using event input .....                          | 5-29 |
|     | Event input allocation .....                     | 5-29 |
| 5.8 | Using transfer output .....                      | 5-32 |
|     | Transfer output settings .....                   | 5-32 |
| 5.9 | Using communication functions .....              | 5-34 |
|     | Setting communication parameters .....           | 5-34 |
|     | Write via communication .....                    | 5-35 |

## Section 6 Communication (CompoWay/F)

|     |  |      |
|-----|--|------|
| 6.1 | Communication method .....   | 6-2  |
|     | CompoWay/F communication protocol .....  | 6-2  |
|     | Communication specifications .....   | 6-2  |
|     | Transfer protocol (Communication/CompoWay/F) .....                             | 6-2  |
| 6.2 | Frames (Communication/CompoWay/F) .....  | 6-4  |
|     | Command frame .....  | 6-4  |
|     | Response frame .....   | 6-5  |
| 6.3 | FINS-mini text .....   | 6-6  |
| 6.4 | Variable areas .....   | 6-7  |
| 6.5 | Reading the variable area .....  | 6-9  |
| 6.6 | Writing to the variable area .....   | 6-10 |
| 6.7 | Operation commands (Communication/CompoWay/F) .....                            | 6-11 |
| 6.8 | Setting areas .....  | 6-13 |
| 6.9 | Commands and responses (Communication/CompoWay/F) .....                        | 6-14 |
|     | Monitor value read (Communication/CompoWay/F) .....                            | 6-14 |
|     | Setting data read (Communication/CompoWay/F) .....                             | 6-15 |
|     | Monitor value / setting data compound read<br>(Communication/CompoWay/F) ..... | 6-16 |
|     | Protect level setting data write .....   | 6-17 |
|     | Setting data write (Communication/CompoWay/F) .....                            | 6-17 |
|     | Setting data compound write (Communication/CompoWay/F) .....                   | 6-18 |
|     | Monitor value / setting data compound read store (write) .....                 | 6-19 |
|     | Monitor value / setting data compound read store check (read) .....            | 6-20 |
|     | Monitor value / setting data compound store read .....                         | 6-20 |



|   |      |
|---|------|
| Write via communication .....                           | 6-21 |
| Control Run / Control Stop .....                        | 6-21 |
| Bank change .....                                       | 6-22 |
| AT execute .....  | 6-23 |
| AT cancel .....   | 6-23 |
| Write mode .....  | 6-24 |
| RAM data store .....                                    | 6-25 |
| Software reset .....                                    | 6-25 |
| Move to setting area 1 .....                            | 6-26 |
| Move to protect level .....                             | 6-26 |
| Auto / Manual .....                                     | 6-27 |
| Initialize settings .....                               | 6-27 |
| Cancel latch .....                                      | 6-28 |
| SP mode .....   | 6-28 |
| Read machine attributes .....                           | 6-29 |
| Controller status read (Communication/CompoWay/F) ..... | 6-30 |
| Echo back test .....                                    | 6-31 |
| 6.10 Program example .....                              | 6-32 |
| N88Basic .....  | 6-32 |

## Section 7 Communication (Modbus)

|   |      |
|---|------|
| 7.1 Communication method .....                          | 7-2  |
| Modbus communication protocol .....                     | 7-2  |
| Communication specifications .....                      | 7-2  |
| Transfer protocol (Communication/Modbus) .....          | 7-2  |
| 7.2 Frames .....  | 7-4  |
| Command frame .....                                     | 7-4  |
| Response frame .....                                    | 7-5  |
| 7.3 List of functions .....                             | 7-7  |
| 7.4 Variable area .....                                 | 7-8  |
| 7.5 Reading the variable area .....                     | 7-10 |
| 7.6 Writing to the variable area .....                  | 7-12 |
| 7.7 Operation commands (Communication/Modbus) .....     | 7-14 |
| 7.8 Setting areas .....                                 | 7-16 |
| 7.9 Commands and responses (Communication/Modbus) ..... | 7-17 |
| Monitor value read (Communication/Modbus) .....         | 7-17 |
| Read setting data (Communication/Modbus) .....          | 7-18 |
| Write setting data to protect level .....               | 7-19 |
| Write setting data (Communication/Modbus) .....         | 7-19 |
| Write via communication .....                           | 7-21 |
| Control Run / Control Stop .....                        | 7-21 |
| Bank change .....                                       | 7-22 |
| AT execute .....  | 7-23 |
| AT cancel .....   | 7-23 |
| Write mode .....  | 7-24 |
| RAM data store .....                                    | 7-25 |
| Software reset .....                                    | 7-25 |
| Move to setting area 1 .....                            | 7-26 |
| Move to protect level .....                             | 7-26 |
| Auto / Manual .....                                     | 7-27 |
| Initialize settings .....                               | 7-27 |
| Cancel latch .....                                      | 7-28 |
| SP mode .....   | 7-28 |
| Echo back test .....                                    | 7-29 |

## Section 8 Setting data

|      |   |       |      |
|------|---|-------|------|
| 8.1  | How to use this section                 | ..... | 8-2  |
| 8.2  | Protect level (L.PrL)                   | ..... | 8-3  |
| 8.3  | Operation level ( )                     | ..... | 8-5  |
| 8.4  | Adjustment level (L.AdJ)                | ..... | 8-12 |
| 8.5  | Adjustment 2 level (L.Ad2)              | ..... | 8-22 |
| 8.6  | Bank setting level (L.bnk)              | ..... | 8-26 |
| 8.7  | PID setting level (L.PId)               | ..... | 8-30 |
| 8.8  | Approximation setting level (L.tE1)     | ..... | 8-33 |
| 8.9  | Input initial setting level (L.I)       | ..... | 8-35 |
| 8.10 | Control initial setting level (L.i)     | ..... | 8-41 |
| 8.11 | Control initial setting 2 level (L.2)   | ..... | 8-45 |
| 8.12 | Alarm setting level (L.A)               | ..... | 8-53 |
| 8.13 | Display adjustment level (L.Y)          | ..... | 8-59 |
| 8.14 | Communication setting level (L.S)       | ..... | 8-63 |
| 8.15 | Advanced function setting level (L.AdF) | ..... | 8-67 |
| 8.16 | Expansion control setting level (L.EuL) | ..... | 8-72 |

## Section 9 User calibration

|     |   |       |      |
|-----|---|-------|------|
| 9.1 | Setting data for user calibration               | ..... | 9-2  |
| 9.2 | User calibration                                | ..... | 9-4  |
| 9.3 | Thermocouple input calibration                  | ..... | 9-5  |
| 9.4 | Analog input calibration                        | ..... | 9-8  |
| 9.5 | Resistance temperature input sensor calibration | ..... | 9-10 |
| 9.6 | Output calibration                              | ..... | 9-12 |
| 9.7 | Inspecting indicator accuracy                   | ..... | 9-13 |

## Section 10 Troubleshooting

|      |   |       |      |
|------|---|-------|------|
| 10.1 | Troubleshooting checklist                                   | ..... | 10-2 |
| 10.2 | Error messages  | ..... | 10-3 |
| 10.3 | Inferring causes from conditions (abnormal measured values) | ..... | 10-4 |
| 10.4 | Inferring causes from conditions (abnormal control)         | ..... | 10-5 |
| 10.5 | Inferring causes from conditions (abnormal output)          | ..... | 10-7 |
| 10.6 | Inferring causes from conditions (communication problems)   | ..... | 10-8 |

## Appendix

|  |       |      |
|--|-------|------|
| Specifications   | ..... | A-2  |
| Unit ratings   | ..... | A-2  |
| Unit performance specifications                          | ..... | A-3  |
| Sensor input setting ranges · Indicator (control) ranges | ..... | A-4  |
| ASCII Codes  | ..... | A-5  |
| Setting list   | ..... | A-6  |
| Initialization due to setting changes                    | ..... | A-28 |
| Setting data list  | ..... | A-30 |

## Index



# Section 1 Overview

|     |   |     |
|-----|---|-----|
| 1.1 | Main Features of the E5AR/ER .....                  | 1-2 |
| 1.2 | Part Names and Functions .....                      | 1-4 |
| 1.3 | Input/output Configuration and Main Functions ..... | 1-7 |

## 1.1 Main Features of the E5AR/ER

The E5AR/ER is an advanced controller that features high-speed and high-precision control.

The E5AR/ER has the following features:

### ■ Inputs

#### ● High-speed sampling

#### ● High accuracy/ high resolution

- 50-ms sampling period
- Accuracy Thermocouple:  
(Larger of  $\pm 0.1\%$  PV or  $\pm 1^\circ\text{C}$ )  $\pm 1$  digit max  
Platinum resistance temperature input sensor:  
(Larger of  $\pm 0.1\%$  PV or  $\pm 0.5^\circ\text{C}$ )  $\pm 1$  digit max  
Analog input: ( $\pm 0.1\%$  FS)  $\pm 1$  digit max  
(For non-standard specifications, see "Specifications" on page A-2 of the Appendix)
- Input resolution:  $1/100^\circ\text{C}$   
(Pt 100: Resolution range  $0.01^\circ\text{C}$ ,  $-150.00$  to  $150.00^\circ\text{C}$  is available)
- High-speed sampling and high accuracy / high resolution are simultaneously achieved to enable high-accuracy, high-speed control to match the application.

#### ● Multi-inputs

- Wide range of temperature inputs and analog inputs are available.  
Temperature inputs :  
Thermocouples K, J, T, E, L, U, N, R, S, B, W  
Platinum resistance temperature input sensors: Pt 100  
Analog inputs: Current inputs: 4 to 20 mA, 0 to 20mA  
Voltage inputs: 1 to 5 V, 0 to 5V, 0 to 10V

#### ● Multi-point inputs

- A 2-input type and a 4-point input type are available for the E5AR. A 2-point input type is available for the E5ER.
- All multi-point inputs also support multi-input, eliminating the need for an externally connected converter.

### ■ Controller

#### ● Banks

- Up to 8 banks can be created to store SPs (local SP), alarm values, and PID set numbers.
- Switch between banks by bank selection (event input, key operation, or communication).

#### ● PID sets

- Up to 8 PID sets can be created to store settings (PID value, MV limits, and automatic selection range upper limit) for PID control.

### ● Ample control modes and control functions

- Selection of a PID is possible not only by direct specification of the PID Set No. in a bank, but also by PID set automatic selection according to the present value and deviation.
- Supports typical control modes (standard control, heating/cooling control, proportional control, cascade control). Note that proportional control and cascade control are only possible on 2-input types.
- Floating control or closed control can be selected for position proportional types. Floating control allows position proportional control without a potentiometer.
- Remote SP  
Two-input types can use an external input for the set point.
- SP ramp function  
This limits the amount of change of the set point based on the rate of change (SP ramp value). This function is useful for control applications such as firing ceramics where sudden changes in temperature are not desirable.  
The E5AR/ER allows an SP ramp rise value and fall value to be set separately.

## ■ Outputs

### ● Multi-output

- Multi-output supporting current output and voltage output (pulse) is available.

### ● High resolution

- Resolution of current output  
0 to 20 mA: Approx. 54,000 resolution  
4 to 20 mA: Approx. 43,000 resolution

### ● Control period

- The control period can be set as short as 0.2 seconds, allowing precise time sharing proportional control.

# 1.2 Part Names and Functions

## ■ Front

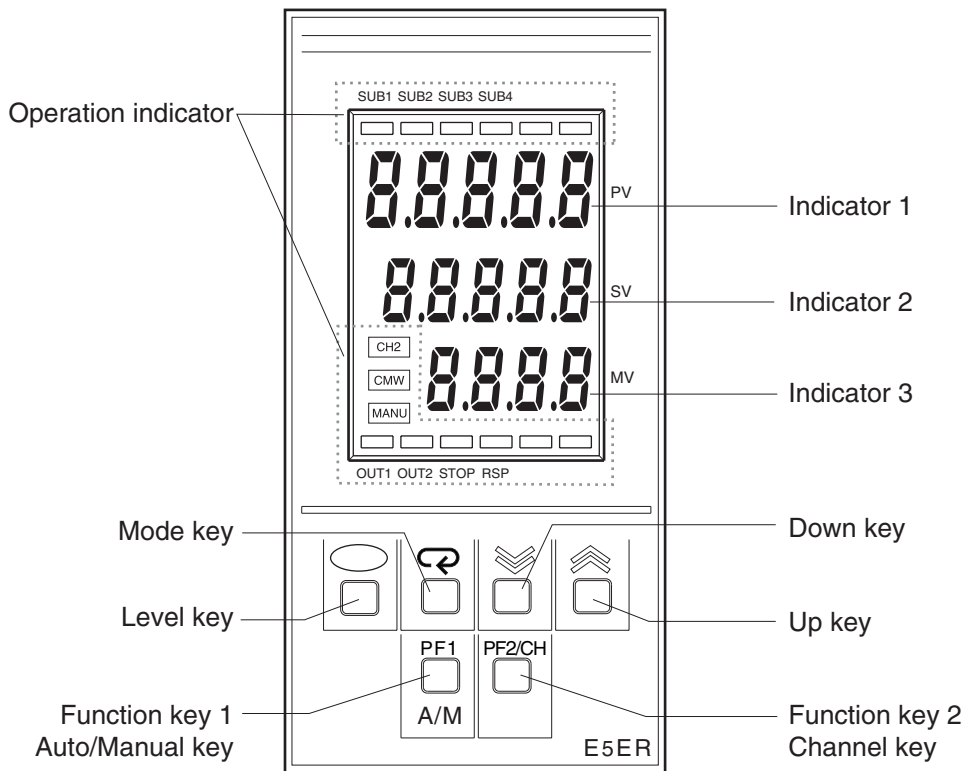
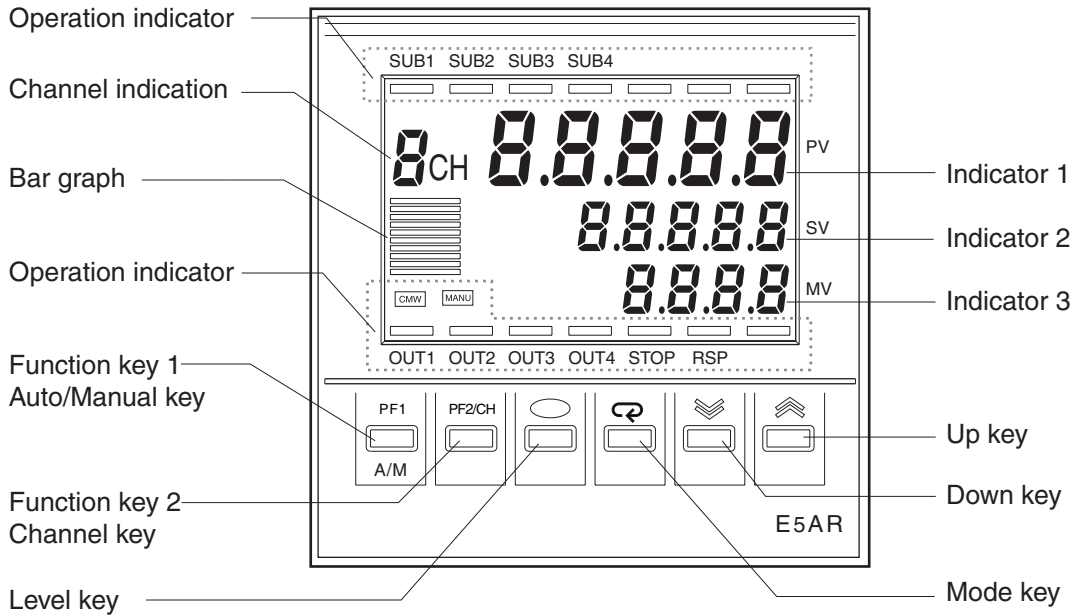

## ■ How to read the display

- **Display 1** Shows the present value and the setting data's name or error name. (Red)
- **Display 2** Shows the set point value and the set value of the setting data. (Green)
- **Display 3** Shows the Manipulated Variable MV and the bank number or level name. (Orange)
- **Channel indication** Shows the set channel number.  
Only appears on a multi-point input type. On a single input type, the display is always off. (Orange)  
The E5ER shows the corresponding channel when the "CH2" operation indicator is lit.
- **Bar graph** Shows a bar graph of the settings.
- **Operation indicators**

| Operation indicators | Model |      | Common indicator/Single channel indicator | Explanation   |
|----------------------|-------|------|---|---|
|                      | E5AR  | E5ER |   |   |
| OUT1                 | ●     | ●    | Common indicator (orange)                 | Turns on/off when control output 1 is ON/OFF.*2   |
| OUT2                 | ●     | ●    |   | Turns on/off when control output 2 is ON/OFF.*2   |
| OUT3                 | ●     | –    |   | Turns on/off when control output 3 is ON/OFF.*2   |
| OUT4                 | ●     | –    |   | Turns on/off when control output 4 is ON/OFF.*2   |
| SUB1                 | ●     | ●    | Common indicator (red)                    | Turns on/off when the output function assigned to auxiliary output 1 is ON/OFF.   |
| SUB2                 | ●     | ●    |   | Turns on/off when the output function assigned to auxiliary output 2 is ON/OFF.   |
| SUB3                 | ●     | ●    |   | Turns on/off when the output function assigned to auxiliary output 3 is ON/OFF.   |
| SUB4                 | ●     | ●    |   | Turns on/off when the output function assigned to auxiliary output 4 is ON/OFF.   |
| STOP                 | ●     | ●    | Single channel indicator (orange)         | Turns on when operation stops. Otherwise is off.<br>Turns on during control at an event input or when "run/stop" is switched to stop. |
| RSP                  | ●     | ●    | Single channel indicator (orange)         | Turns on when the SP mode is set to remote. Otherwise is off.   |
| MANU                 | ●     | ●    | Single channel indicator (orange)         | Turns on when operation is set to manual mode. Otherwise is off.  |
| CMW                  | ●     | ●    | Common indicator (orange)                 | Turns on/off when write via communication is ON/OFF (enabled/disabled).   |
| CH2                  | –     | ●    | Single channel indicator (orange)         | Turns on when the displayed channel is 2. Otherwise is off.   |

\*1: ●: Indicates that the model has the function. Note that function may be disabled depending on the settings, and in this case the indicator is always off.

–: Indicates that the model does not have the function.



\*2: When the control output is current output, the indicator turns off when the MV is 0% or less, and turns on when the manipulated variable is greater than 0%.

## Explanation of the keys

| Key | Name                             | Explanation   |
|-----|----------------------------------|---|
|     | Level key                        | Press to change setting levels.   |
|     | Mode key                         | Press to change the setting data within a setting level.  |
|     | Up key                           | Each time  is pressed, the value of display 2 increases. Hold down the key to increase the value quickly. The key is also used to scroll forward through the setting item.  |
|     | Down key                         | Each time  is pressed, the value of display 2 decreases. Hold down the key to decrease the value quickly. The key is also used to scroll backward through the setting item.   |
|     | Protect key                      | Press to change to a protected level. See "4.1 Configuration of Setting Levels and Key Operation" (page 4-2) for operation when the  key and  are pressed simultaneously.   |
|     | Function key 1 / Auto/Manual key | When pressed, this function key activates the function set in "PF1 setting".<br>Example: "PF1 setting" is "A/M" ("A/M" is the default setting)<br>Functions as an Auto / Manual key (hereafter shown as the  key) that is used to switch between auto mode and manual mode. The mode changes when the key is pressed for at least one second (the timing of key release does not matter).                           |
|     | Function key 2 / channel key     | Functions as a channel key for multi-channel control.*<br>For 1-point input types, the key acts as a function key that activates the function set in "PF2 setting" when pressed.<br>When used as a channel key:<br>Switches channels on models with a multi-channel configuration. The channel switching sequence is as follows:<br>CH1 → CH2 → ... → Highest channel set in "Enabled channel setting"<br>↑ _____ ↓ |

\*Functions as a start key for the displayed scan.

# 1.3 Input/output Configuration and Main Functions

## Input/output configuration

The input/output configuration of the E5AR/ER and internal setting item are shown in the following diagram.

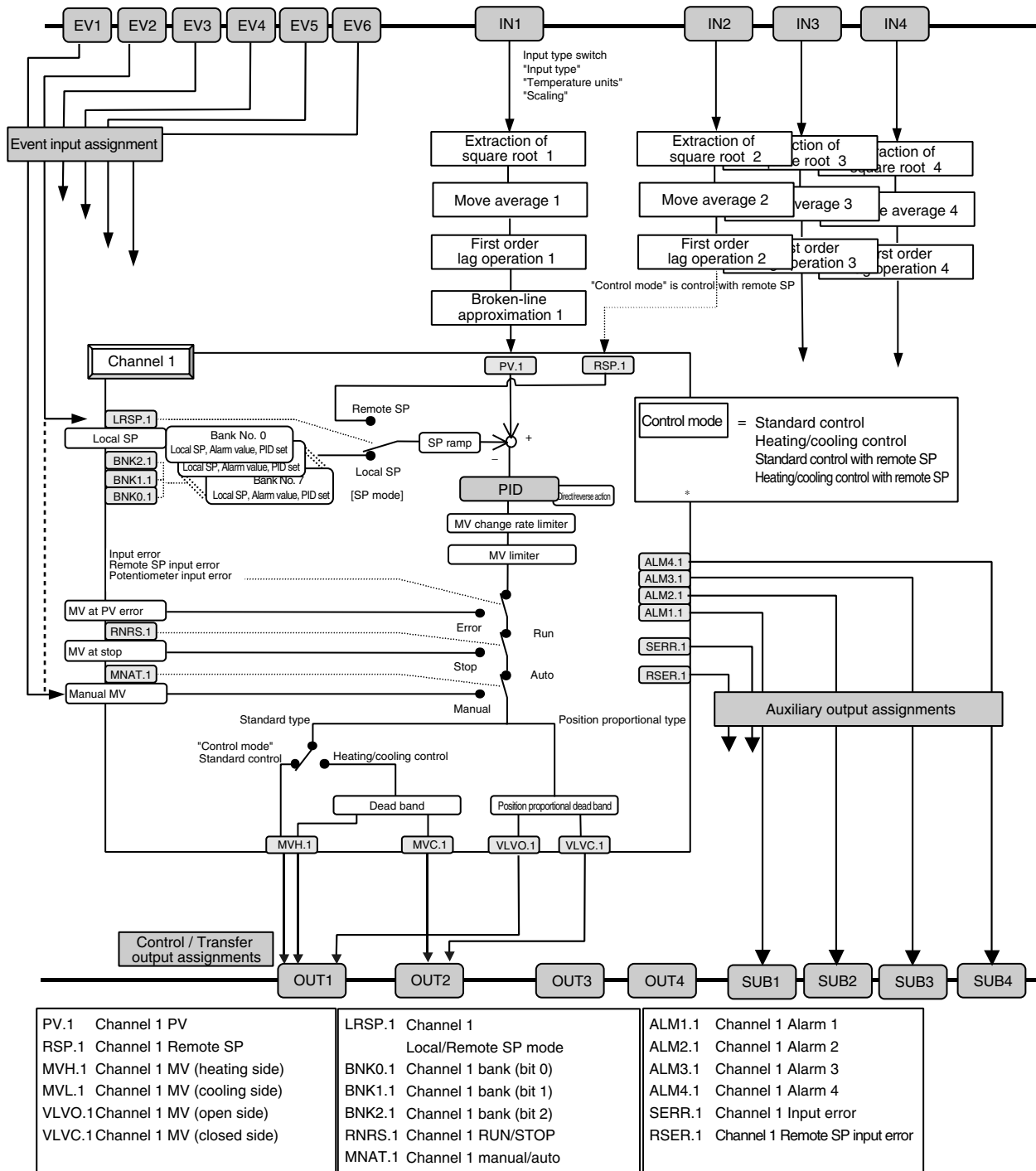

Multi-point input types have the same setting data for channels 2 to 4 depending on the number of input points.

\* Cascade standard control, Cascade heating/cooling control, position proportional control and ratio control are also available. See "Section 3, Typical Control Examples" (page 3-1).

## ■ Main functions

### ● Input

After selecting the temperature input (TC: thermocouple or PT: resistance temperature input sensor) or analog input (current input or voltage input), with the input type switch select the input type in parameter setting.

If the input type SW is set to temperature input (resistance temperature input sensor or thermocouple), the temperature unit can be set. If the input type SW is set to analog input (current input or voltage input), scaling and the decimal point position can be set.

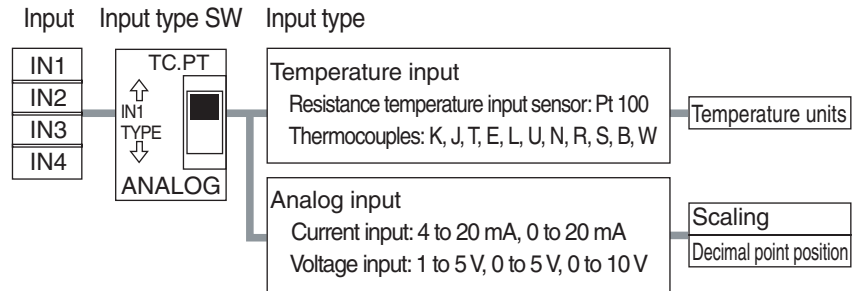

### Location of input type switch

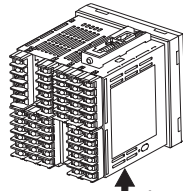

Input type SW (bottom)

### ● Event input assignment

An operation command can be assigned to each event input. If event input is to be used, use an E5AR/ER-□□B/D.

In the case of a multi-point input type, assignment data can be set for channels 2 and higher as needed for the number of channels.

The operation instruction "Write via communication OFF/ON" is common to all channels

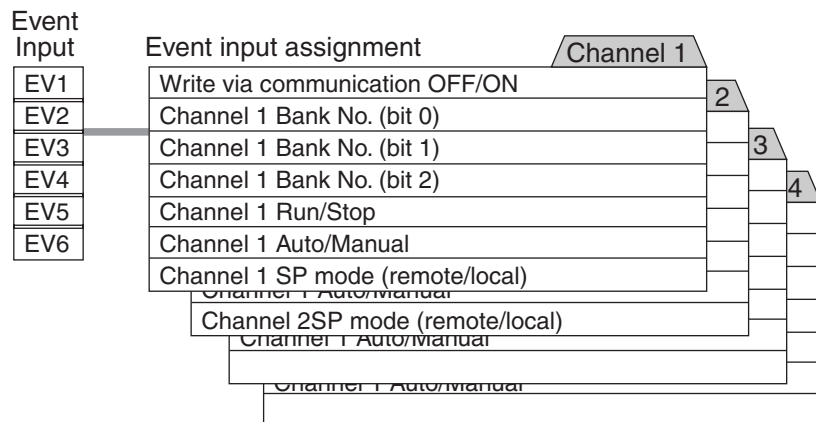

## ● Control mode

The type of control performed by each controller is selected by setting the control mode. Setting the control mode sets default values for the output assignments required for the control.

After setting the control mode, specify direct / reverse operation for each channel.

### Standard type

Control modes that can be selected vary depending on the number of input points.

| Control mode                           | 1-input type | 2-input type                             | 4-input type | Out-put      | Control / Transfer output assignment   |
|--|--------------|--|--------------|--------------|--|
| Standard control                       | IN1          | IN1                                      | IN1          | OUT1         | Channel 1 control output (heating side)  |
|  |              | IN2                                      | IN2          | OUT2         | Channel 2 control output (heating side)  |
|  |              |  | IN3          | OUT3         | Channel 3 control output (heating side)  |
|  |              |  | IN4          | OUT4         | Channel 4 control output (heating side)  |
| Heating/cooling control                | IN1          | IN1                                      | IN1          | OUT1         | Channel 1 control output (heating side)  |
|  |              |  |              | OUT2         | Channel 1 control output (cooling side)  |
|  |              | IN2                                      | IN2          | OUT3         | Channel 2 control output (heating side)  |
|  |              |  |              | OUT4         | Channel 1 control output (cooling side)  |
| Standard control with remote SP        | –            | IN1<br>IN2: Remote SP                    | –            | OUT1         | Channel 1 control output (heating side)  |
| Heating/cooling control with remote SP | –            | IN1<br>IN2: Remote SP                    | –            | OUT1<br>OUT2 | Channel 1 control output (heating side)<br>Channel 1 control output (cooling side) |
| Ratio control                          | –            | IN1<br>IN2: Ratio setting                | –            | OUT1         | Channel 1 control output (heating side)  |
| Cascade standard control               | –            | IN1: Primary loop<br>IN2: Secondary loop | –            | OUT1         | Channel 2 control output (heating side)  |
| Cascade heating/cooling control        | –            | IN1: Primary loop<br>IN2: Secondary loop | –            | OUT1<br>OUT2 | Channel 1 control output (heating side)<br>Channel 1 control output (cooling side) |

| Direct/Reverse operation    | Description   |
|-----------------------------|---|
| Direct operation (cooling)  | Control whereby the MV is increased as the present value increases<br>(When the present value (PV) is higher than the set point (SP), the MV is increased in proportion to the difference between the PV and the SP.) |
| Reverse operation (heating) | Control whereby the MV is decreased as the present value increases<br>(When the present value (PV) is lower than the set point (SP), the MV is increased in proportion to the difference between the PV and the SP.)  |

- When pulse output is used, the control period must be set for each channel.

**Position proportional type**

The position proportional type only uses standard control.

| Control mode     | 1-input type | 2-input type | 4-input type | Out-put | Control / Transfer output assignment   |
|------------------|--------------|--------------|--------------|---------|--|
| Standard control | IN1          | -            | -            | OUT1    | Channel 1 control output (open side)   |
|                  |              |              |              | OUT2    | Channel 1 control output (closed side) |

| Direct/Reverse action    | Description   |
|--------------------------|---|
| Direct action (cooling)  | Control whereby the MV is increased as the present value increases<br>(When the present value (PV) is higher than the set point (SP), the MV is increased in proportion to the difference between the PV and the SP.) |
| Reverse action (heating) | Control whereby the MV is decreased as the present value increases<br>(When the present value (PV) is lower than the set point (SP), the MV is increased in proportion to the difference between the PV and the SP.)  |

- Floating control and closed control can also be selected for the position proportional type. Floating control allows position proportional control without a potentiometer.

**● Control / Transfer output allocation**

Use this setting to assign what type of data is output from each output. For the multi-point input type, assignment data can be set for channels 2 and higher as needed for the number of channels.

| Output | Control / transfer output allocation | Channel 1 | 2 | 3 | 4 |
|--------|--------------------------------------|-----------|---|---|---|
| OUT1   | Channel 1 control output (heat)      |           |   |   |   |
| OUT2   | Channel 1 control output (cool)      |           |   |   |   |
| OUT3   | Channel 1 SP                         |           |   |   |   |
| OUT4   | Channel 1 ramp SP                    |           |   |   |   |
|        | Channel 1 present value              |           |   |   |   |
|        | Channel 1 control output (heat)      |           |   |   |   |
|        | Channel 1 control output (cool)      |           |   |   |   |
|        | Channel 1 valve opening              |           |   |   |   |
|        | Channel 2 control output (heat)      |           |   |   |   |
|        | Channel 2 control output (cool)      |           |   |   |   |
|        | Channel 3 control output (heat)      |           |   |   |   |
|        | Channel 4 control output (heat)      |           |   |   |   |

When used for control output, assignments are made automatically based on the control mode setting as explained on the previous page. No changes are necessary.

When used for transfer output type, assign the data to be transferred to an unused output.

For outputs supporting multi-output, specify pulse voltage output or linear current output according to the multi-output output type.

For linear current output, 0 to 20 mA or 4 to 20 mA can be selected. Pulse voltage output is 12 V DC, 40 mA.

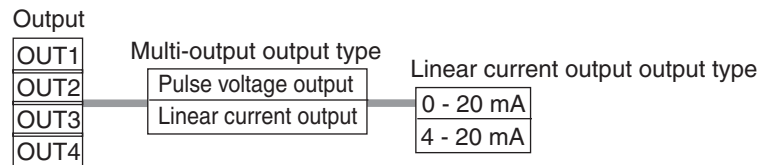

● **Auxiliary output assignments**

Use this setting to assign what type of data is output from each auxiliary output.

For the multi-point input type, assignment data can be set for channels 2 and higher as needed for the number of channels. The U-ALM output is an OR output with alarm functions 1 to 4 for all channels.

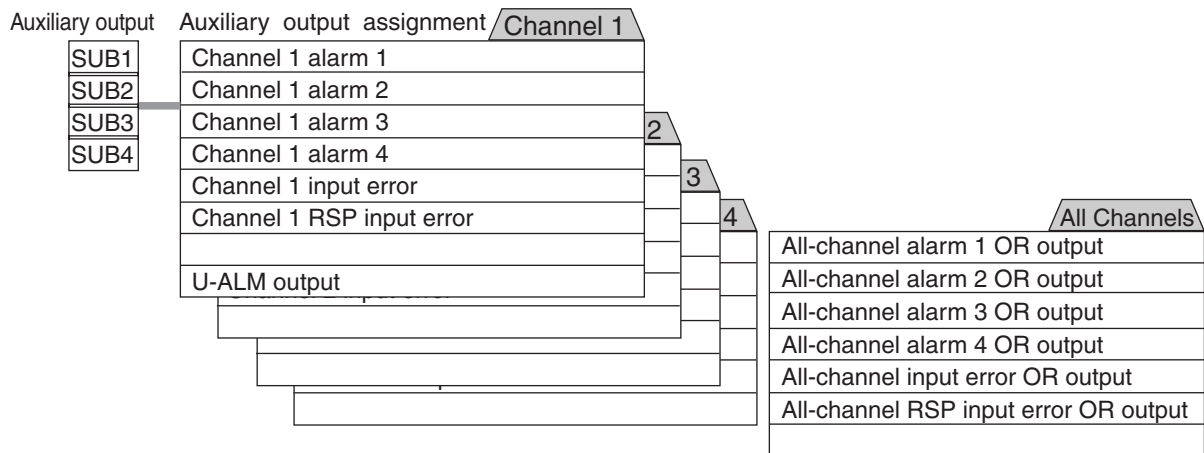

## ■ Explanation of Model Numbers

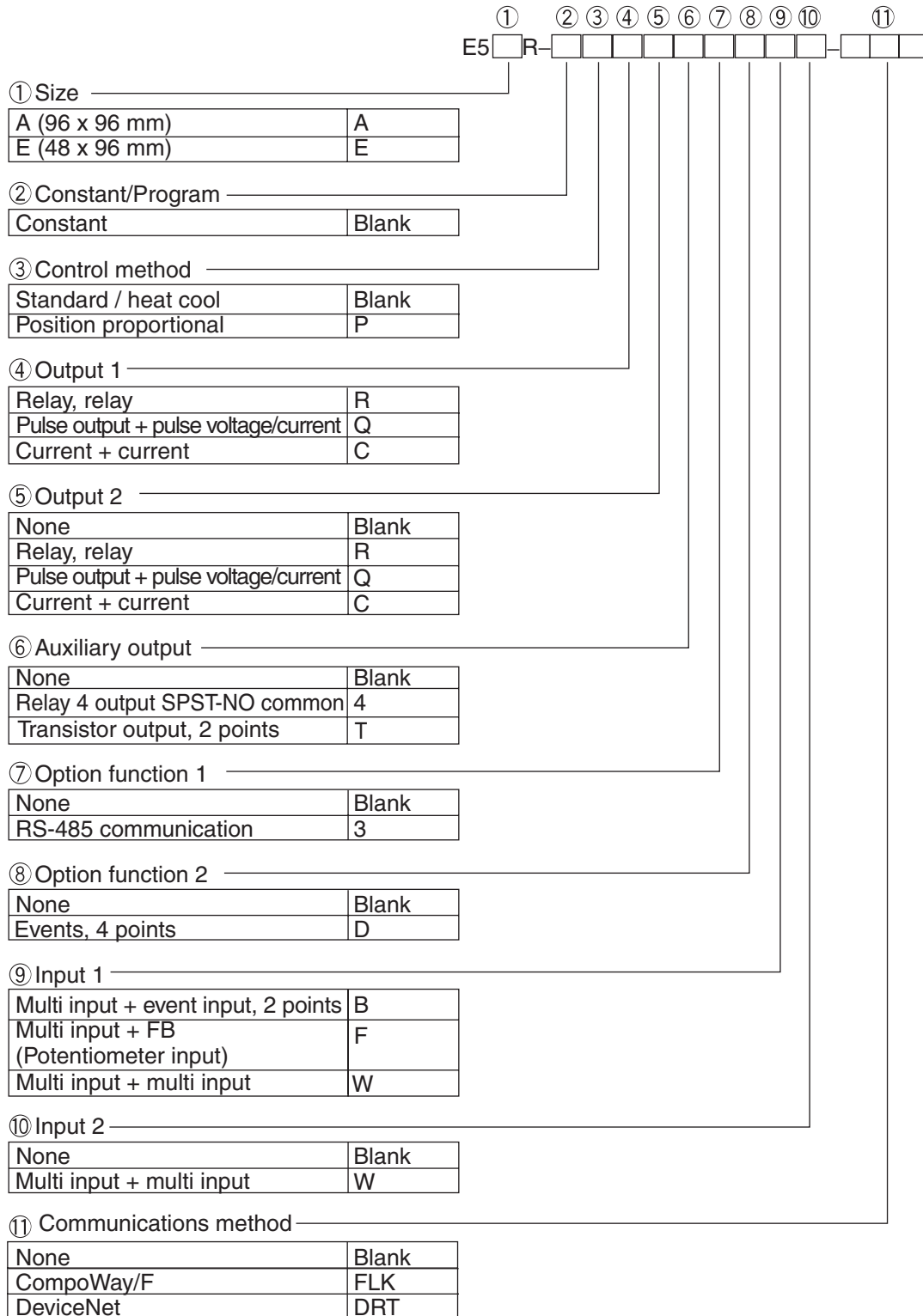

The above is an explanation based on functionality. There may be some differences from the product line depending on the combination of features selected. Please check the catalogue when ordering. For details on using DeviceNet communications functions, refer to the *E5AR/E5ER Digital Controller DeviceNet Communications User's Manual (H124)*.

# Section 2 Preparations

|     |                               |     |
|-----|-------------------------------|-----|
| 2.1 | Installation .....            | 2-2 |
| 2.2 | How to Use the Terminals..... | 2-4 |



## 2.1 Installation

### ■ Dimensions

E5AR

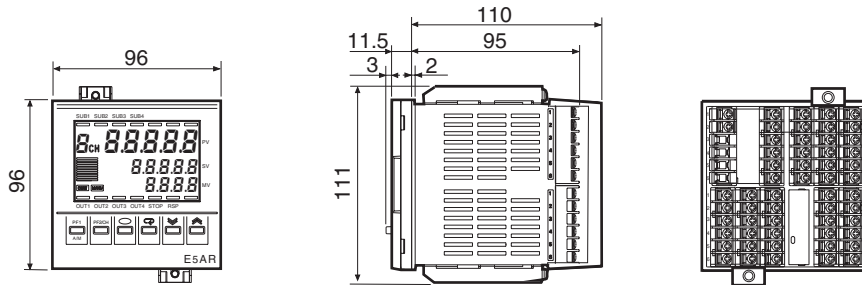

E5ER

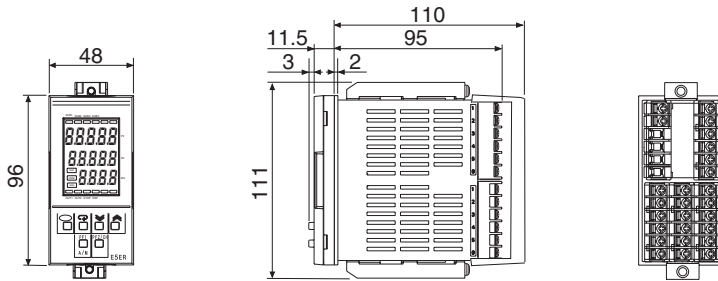

### ■ Installation

#### ● Panel cutout dimensions

E5AR

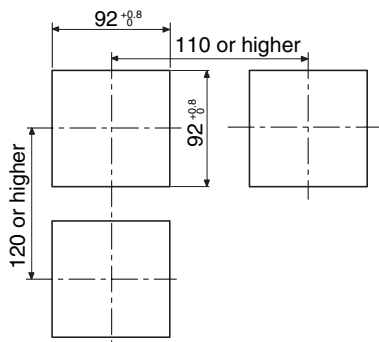

E5ER

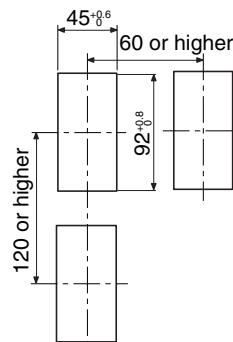

## ● Installation procedure

- ① If the front of the unit needs to be watertight, attach the provided watertight packing. If the front of the unit does not need to be watertight, the watertight packing does not need to be attached.
- ② Insert the unit into the cutout in the panel.
- ③ Insert the accompanying fittings into the grooves on the top and bottom of the rear case.
- ④ Gradually tighten the screws in the top and bottom fittings, alternating between each so that they are balanced. Tighten until the ratchet turns without engaging.

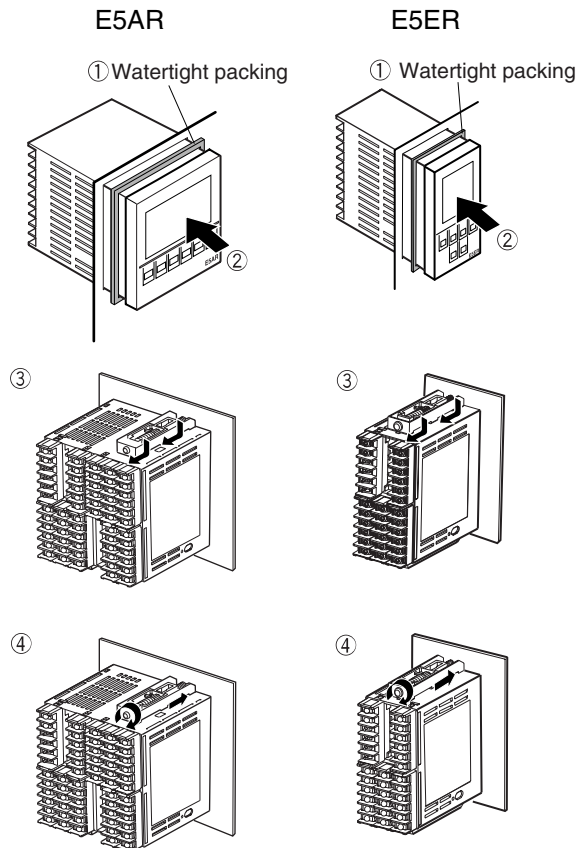

## ● Pulling the unit out

Normally there is no need to pull out the unit, however, it can be pulled out if needed for maintenance purposes.

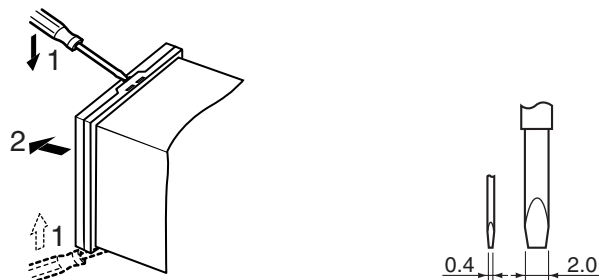

When pulling the unit out, place a cloth over the screwdriver to prevent scratches and other damage.

## 2.2 How to Use the Terminals

Verify the layout of the terminals (A - , 1 - ) using the engravings on the top and sides of the case

### ■ E5AR

#### E5AR-Q4B

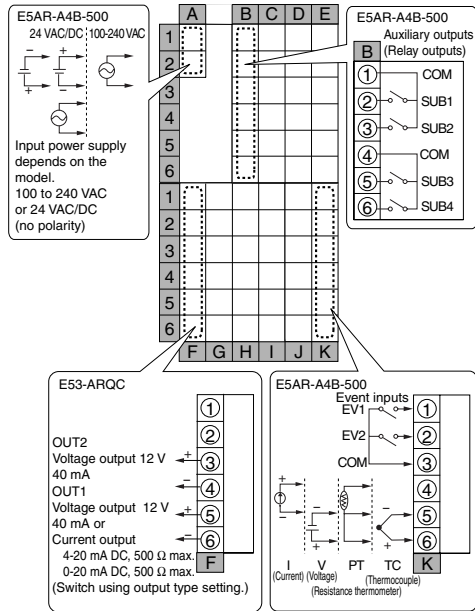

#### E5AR-C4B

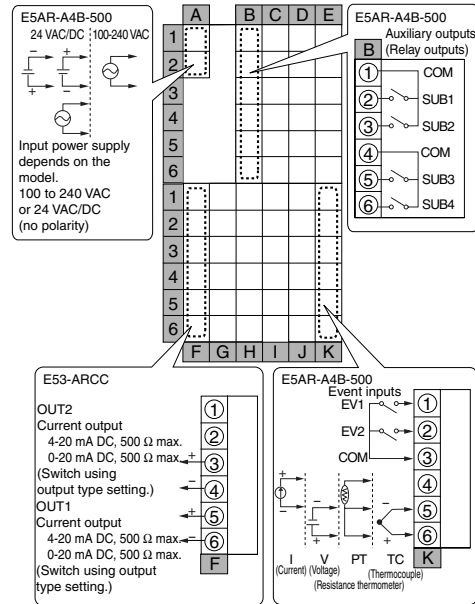

#### E5AR-Q43B-FLK

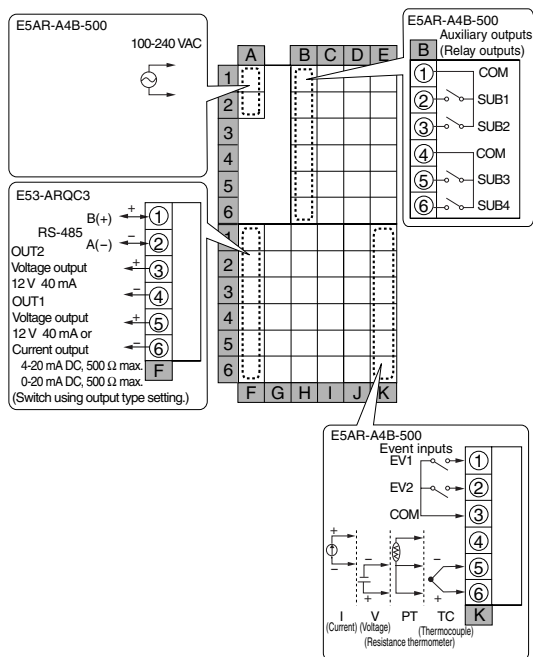

#### E5AR-C43B-FLK

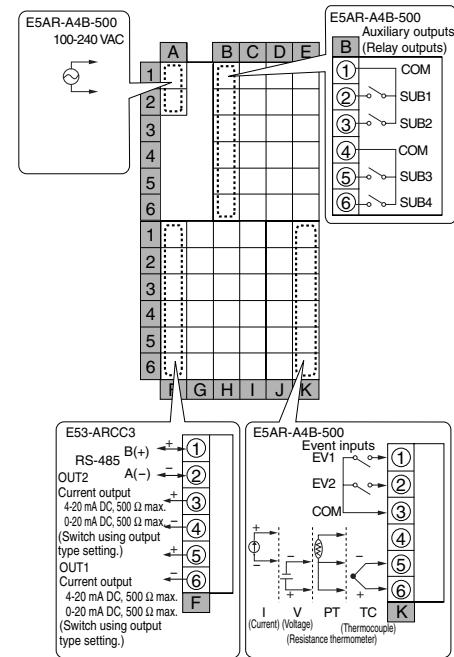

E5AR-Q43DB-FLK

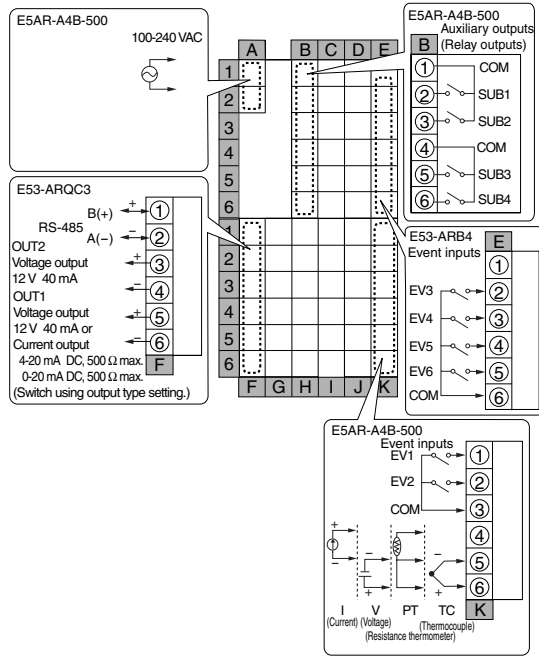

E5AR-C43DB-FLK

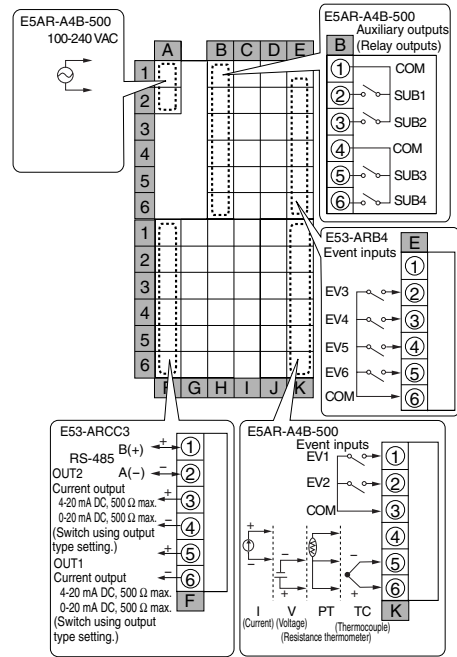

E5AR-QC43DB-FLK

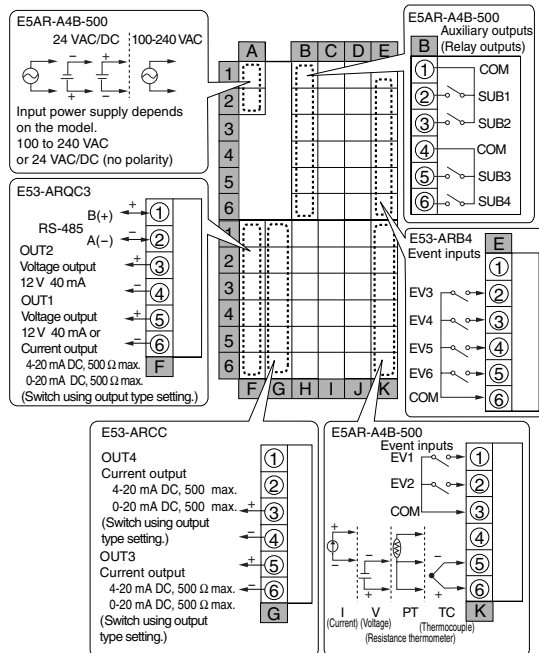

### E5AR-Q43DW-FLK (2-loop Control)

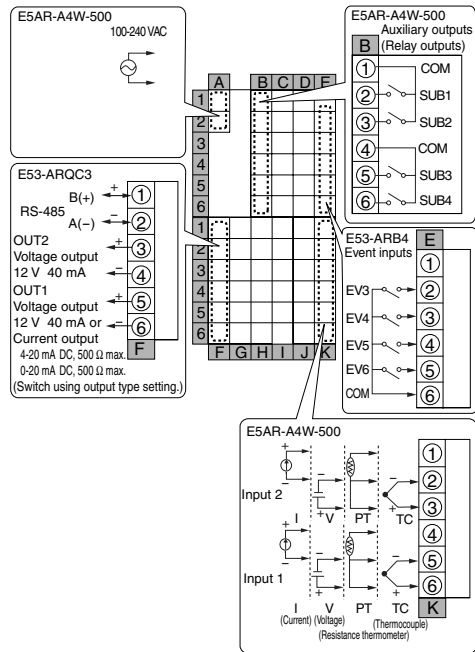

### E5AR-C43DW-FLK (2-loop Control)

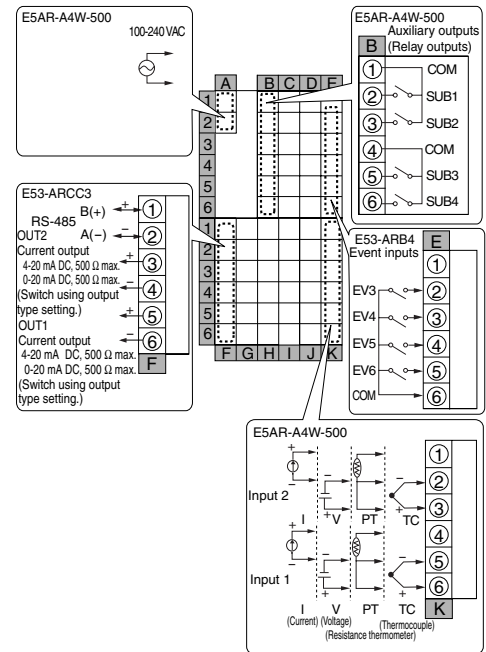

### E5AR-QQ43DW-FLK (2-loop Control)

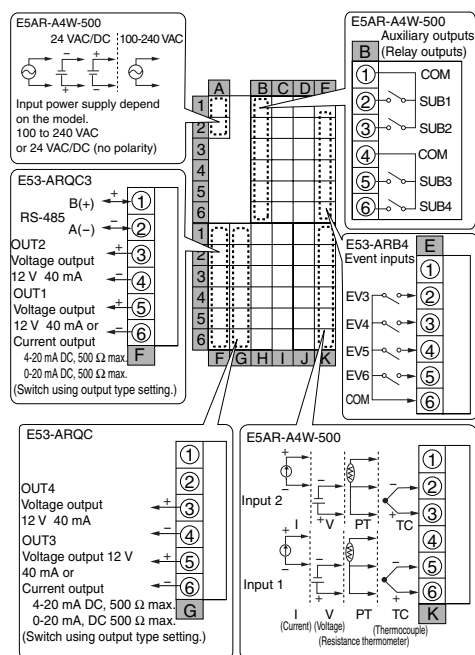

**E5AR-CC43DWW-FLK (4-loop Control)**

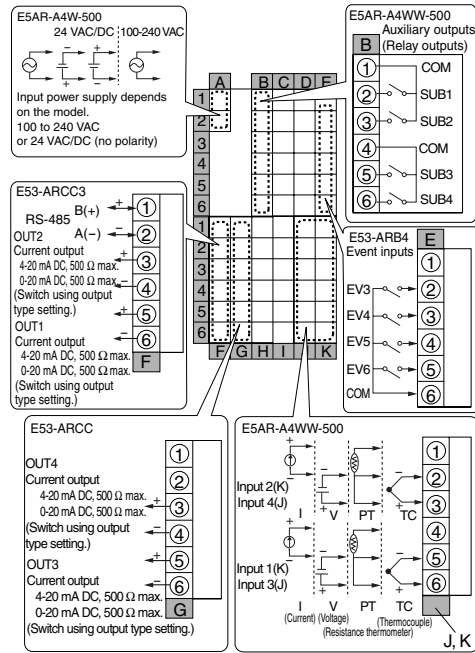

**E5AR-QQ43DWW-FLK (4-loop Control)**

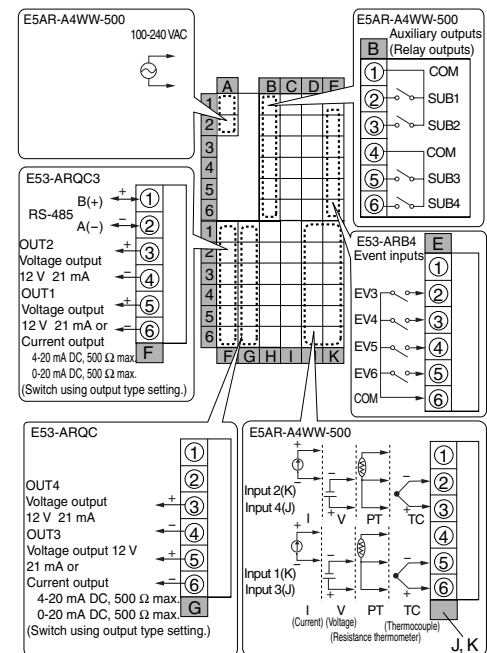

**E5AR-PR4DF**

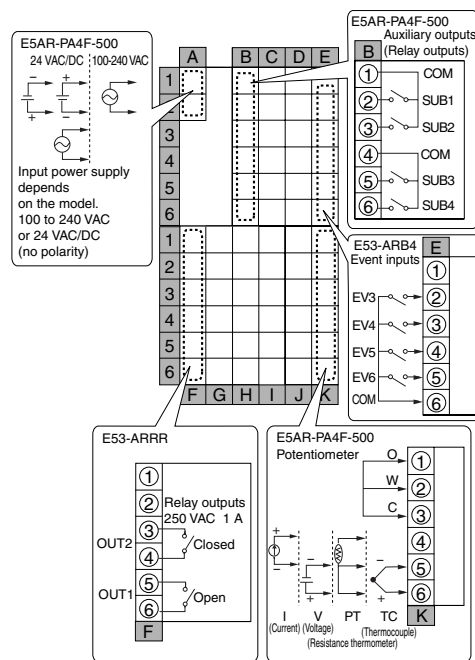

**E5AR-PRQ43DF-FLK**

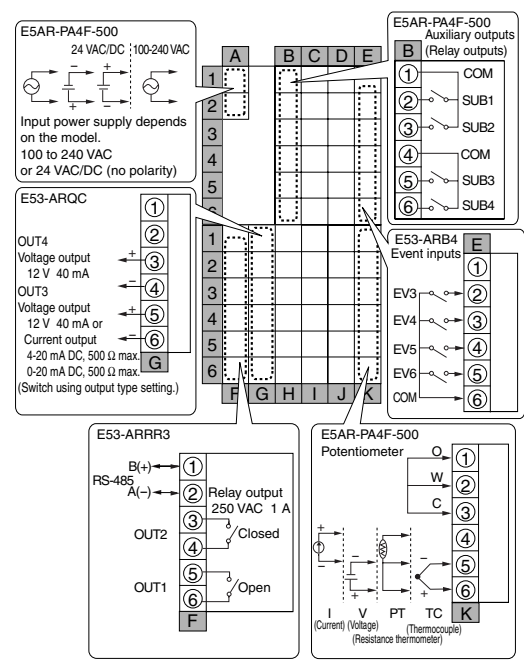

## E5ER

### E5ER-Q4B

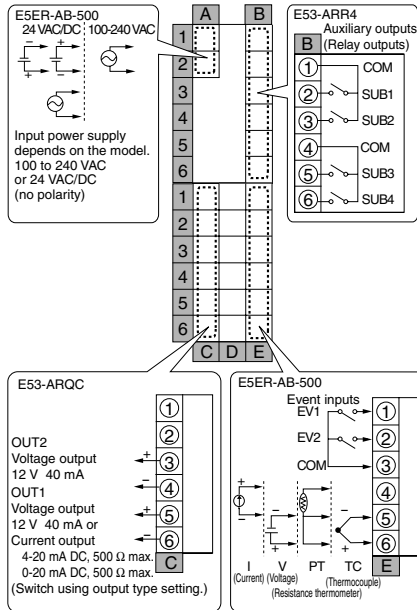

### E5ER-C4B

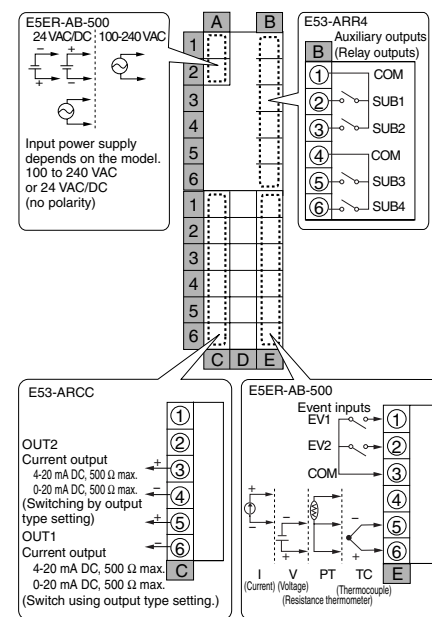

### E5ER-Q43B-FLK

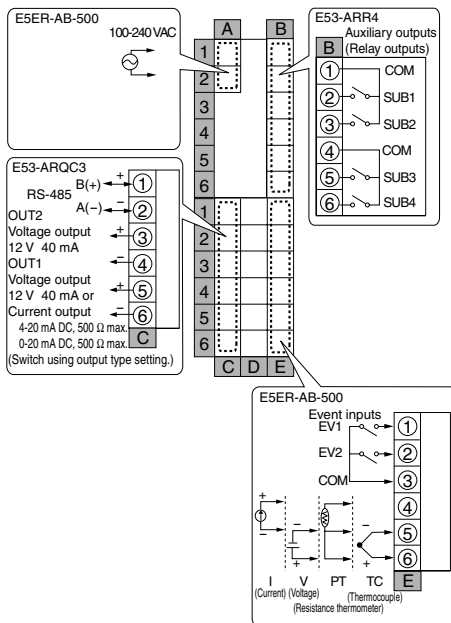

### E5ER-C43B-FLK

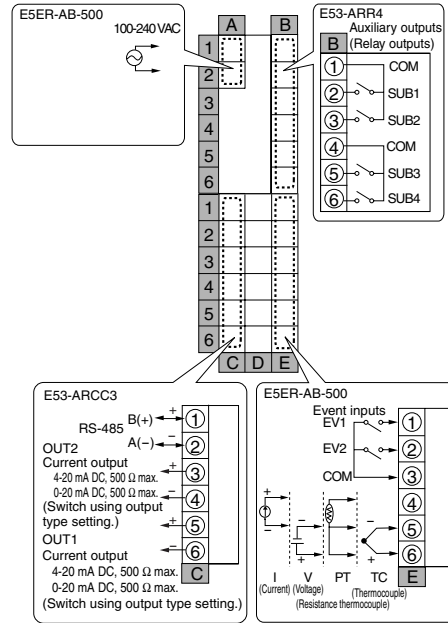

**E5ER-QT3DB-FLK**

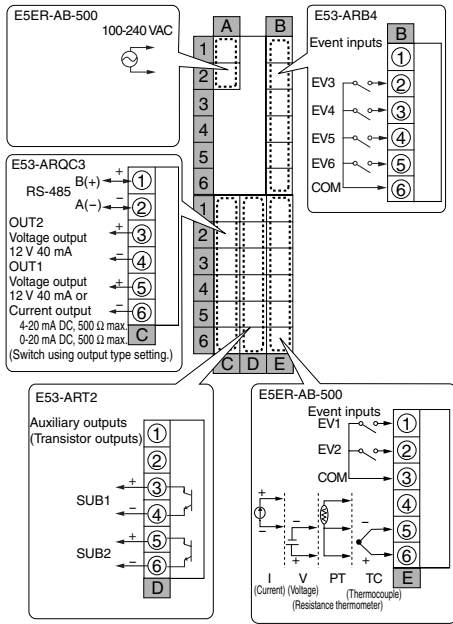

**E5ER-CT3DB-FLK**

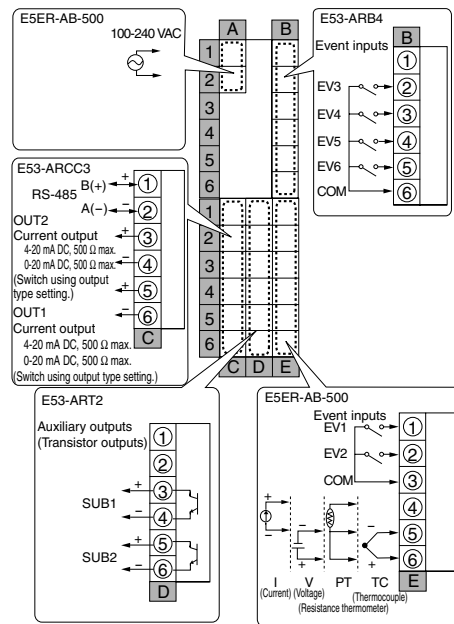

**E5ER-QC43B-FLK**

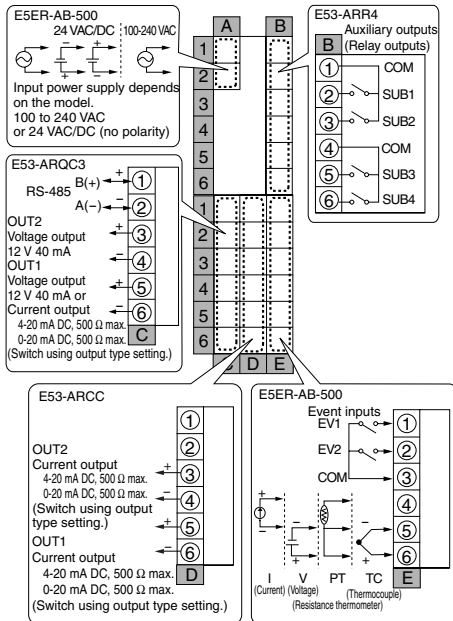



### E5ER-QT3DW-FLK (2-loop Control)

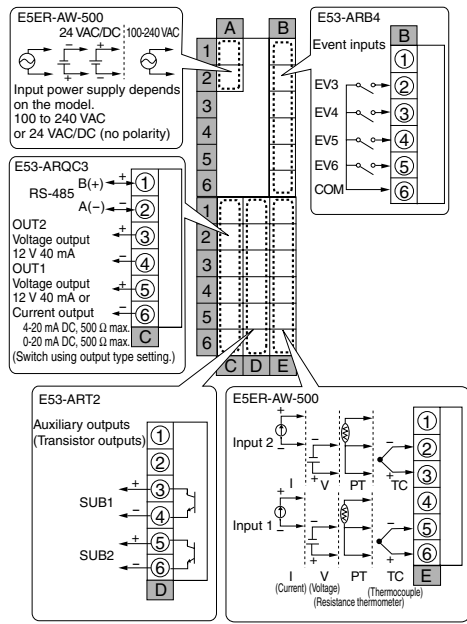

### E5ER-CT3DW-FLK (2-loop Control)

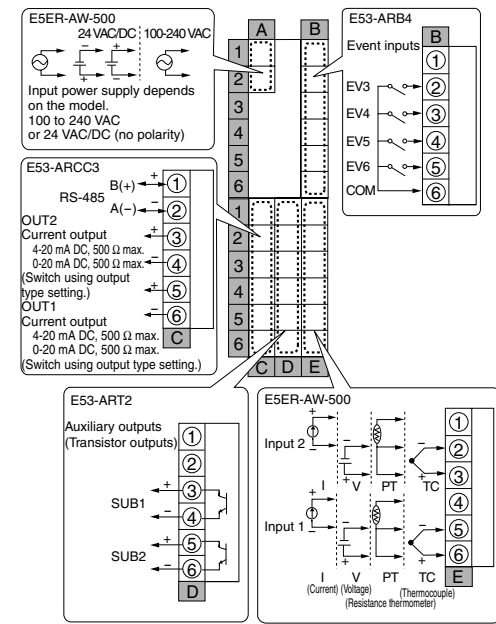

### E5ER-PRTDF

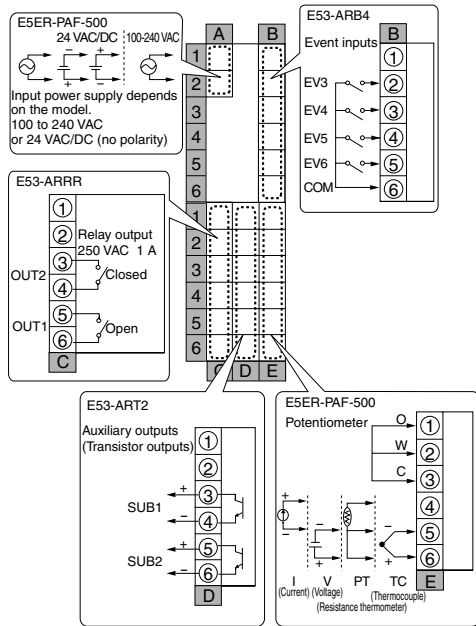

### E5ER-PRQ43F-FLK

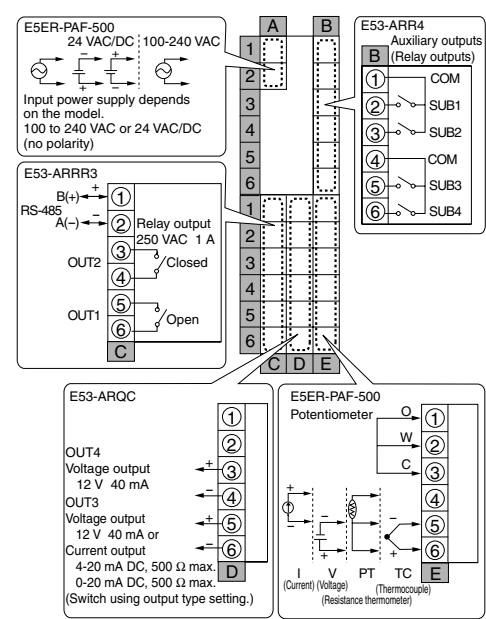

## ■ Precautions when wiring

- To avoid the effects of noise, wire the signal wires and the power line separately.
- Use crimp terminals to connect to the terminals.
- Tighten screws to a torque of 0.40 to 0.56 N·m.
- The crimp terminals should be type M3 and either of the following shapes:



## ■ Wiring

The inside of the frame around terminal numbers in the schematics indicates the interior of the unit, and the outside of the frame indicates the exterior.

### ● Power supply (terminals)

E5AR

|   |   |   |   |   |   |   |   |
|---|---|---|---|---|---|---|---|
|   | A |   | B | C | D | E |   |
| 1 |   |   |   |   |   |   | 1 |
| 2 |   |   |   |   |   |   | 2 |
| 3 |   |   |   |   |   |   | 3 |
| 4 |   |   |   |   |   |   | 4 |
| 5 |   |   |   |   |   |   | 5 |
| 6 |   |   |   |   |   |   | 6 |
|   | F | G | H | I | J | K |   |

E5ER

|   |   |   |   |   |
|---|---|---|---|---|
|   | A |   | B |   |
| 1 |   |   |   | 1 |
| 2 |   |   |   | 2 |
| 3 |   |   |   | 3 |
| 4 |   |   |   | 4 |
| 5 |   |   |   | 5 |
| 6 |   |   |   | 6 |
|   | C | D | E |   |

- Connect terminals A1 to A2 as follows:

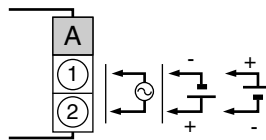

The input power supply varies depending on the model.  
100-240 V AC or 24 V AC/DC (no polarity)

| Input voltage         | E5AR  | E5ER  |
|-----------------------|-------|-------|
| 100-240 V AC 50/60Hz  | 22 VA | 17 VA |
| 24 V AC 50/60Hz       | 15 VA | 11 VA |
| 24 V DC (no polarity) | 10 W  | 7 W   |

● **Inputs (terminals)**

E5AR

|   | A | B | C | D   | E   |   |
|---|---|---|---|-----|-----|---|
| 1 |   |   |   |     |     | 1 |
| 2 |   |   |   |     |     | 2 |
| 3 |   |   |   |     |     | 3 |
| 4 |   |   |   |     |     | 4 |
| 5 |   |   |   |     |     | 5 |
| 6 |   |   |   |     |     | 6 |
| 1 |   |   |   |     |     | 1 |
| 2 |   |   |   | IN4 | IN2 | 2 |
| 3 |   |   |   |     |     | 3 |
| 4 |   |   |   |     |     | 4 |
| 5 |   |   |   | IN3 | IN1 | 5 |
| 6 |   |   |   |     |     | 6 |
| F | G | H | I | J   | K   |   |

E5ER

|   | A | B |   |
|---|---|---|---|
| 1 |   |   | 1 |
| 2 |   |   | 2 |
| 3 |   |   | 3 |
| 4 |   |   | 4 |
| 5 |   |   | 5 |
| 6 |   |   | 6 |
| 1 |   |   | 1 |
| 2 |   |   | 2 |
| 3 |   |   | 3 |
| 4 |   |   | 4 |
| 5 |   |   | 5 |
| 6 |   |   | 6 |
| C | D | E |   |

- For Input 1 (IN1), connect terminals K4 to K6 on the E5AR, or E4 to E6 on the E5ER, as follows according to the input type.
- For a multi-point input type, connect inputs 2 to 4 (IN2 to IN4) in the same way according to the number of input points.

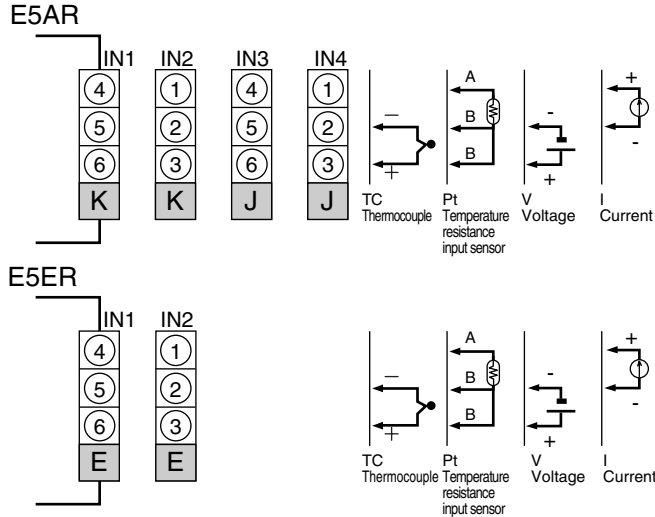

To prevent the appearance of error displays due to unused inputs, set the Number of enabled channels.

● **Control outputs / Transfer outputs (terminals)**

E5AR

|   | A | B | C | D | E |   |
|---|---|---|---|---|---|---|
| 1 |   |   |   |   |   | 1 |
| 2 |   |   |   |   |   | 2 |
| 3 |   |   |   |   |   | 3 |
| 4 |   |   |   |   |   | 4 |
| 5 |   |   |   |   |   | 5 |
| 6 |   |   |   |   |   | 6 |
| 1 |   |   |   |   |   | 1 |
| 2 |   |   |   |   |   | 2 |
| 3 |   |   |   |   |   | 3 |
| 4 |   |   |   |   |   | 4 |
| 5 |   |   |   |   |   | 5 |
| 6 |   |   |   |   |   | 6 |
| F | G | H | I | J | K |   |

E5ER

|   | A | B |   |
|---|---|---|---|
| 1 |   |   | 1 |
| 2 |   |   | 2 |
| 3 |   |   | 3 |
| 4 |   |   | 4 |
| 5 |   |   | 5 |
| 6 |   |   | 6 |
| 1 |   |   | 1 |
| 2 |   |   | 2 |
| 3 |   |   | 3 |
| 4 |   |   | 4 |
| 5 |   |   | 5 |
| 6 |   |   | 6 |
| C | D | E |   |

- On the E5AR, control output 1 (OUT1) outputs to terminals F5 to F6, and control output 2 (OUT2) outputs to terminals F3 to F4.
- On the E5ER, control output 1 (OUT1) outputs to terminals C5 to C6, and control output 2 (OUT2) outputs to terminals C3 to C4.
- On a multi-point input type, output takes place from control output 3 (OUT3) and control output 4 (OUT4).

E5AR  
Pulse voltage output

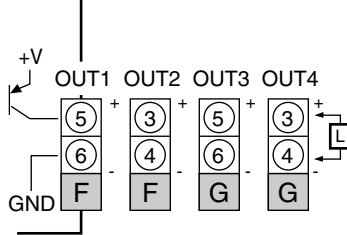

Linear current output

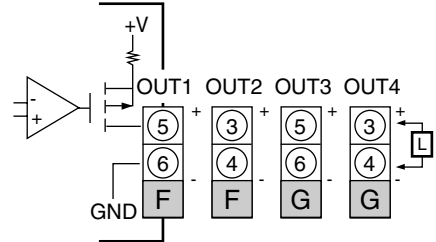

E5ER  
Pulse voltage output

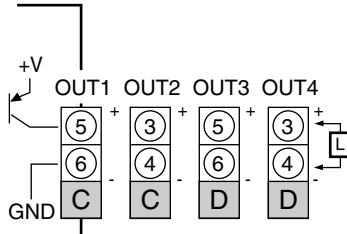

Linear current output

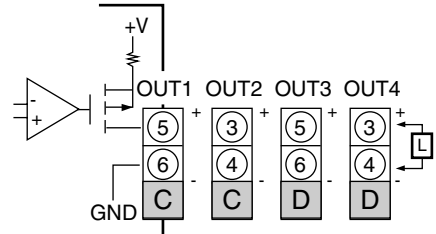

- If terminals ⑤ and ⑥ are used for pulse voltage output, approximately 2 V are output when the power is turned on. (Load resistance: 10 kΩ max. for 10 msec)
- In the case of linear current output, approximately 2 mA are output for 1 second when the power is turned on.

- Control outputs that are not used for control can be used for transfer output with the "control output / transfer output assignment" setting.
- Specifications for each output type are as follows:

| Output type                  | Specifications  |
|------------------------------|---|
| <b>Pulse voltage output</b>  | Output voltage: 12 V DC+15%, -20%(PNP)<br>Max. load current: 40mA*, with short-circuit protection circuit |
| <b>Linear current output</b> | 0-20 mA DC (resolution: approx. 54,000)<br>4-20 mA DC (resolution: approx. 43,000)<br>Load: 500 Ω max.    |

- \* The value for the E5AR-QQ□□□WW-□□□ is 21 mA max.
- The position proportional type has relay outputs (250 V AC, 1 A). Control output 1 (OUT1) is open output and control output 2 (OUT2) is closed output.

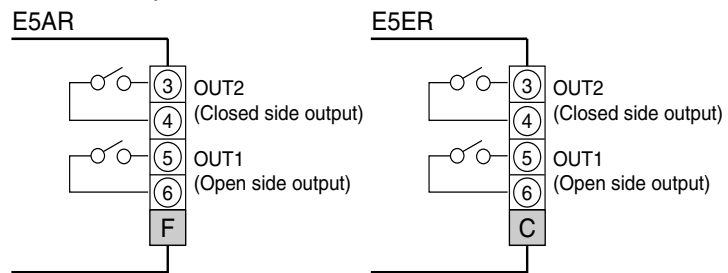

- Relay output specifications are as follows:  
250 V AC, 1 A (including inrush current)
- On the E5AR-□4□□, auxiliary outputs 1 to 4 (SUB1 to 4) output to terminals B1 to B6.

**● Auxiliary outputs (terminals)**

E5AR

|   | A | B    | C | D | E |   |
|---|---|------|---|---|---|---|
| 1 |   | COM  |   |   |   | 1 |
| 2 |   | SUB1 |   |   |   | 2 |
| 3 |   | SUB2 |   |   |   | 3 |
| 4 |   | COM  |   |   |   | 4 |
| 5 |   | SUB3 |   |   |   | 5 |
| 6 |   | SUB4 |   |   |   | 6 |
| 1 |   |      |   |   |   | 1 |
| 2 |   |      |   |   |   | 2 |
| 3 |   |      |   |   |   | 3 |
| 4 |   |      |   |   |   | 4 |
| 5 |   |      |   |   |   | 5 |
| 6 |   |      |   |   |   | 6 |
|   | F | G    | H | I | J | K |

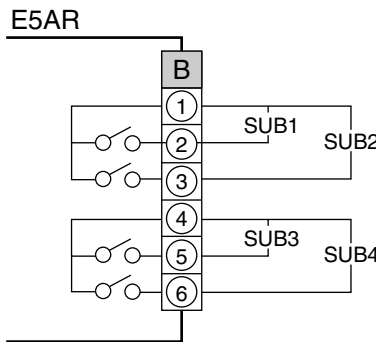

E5ER

|   | A | B    |   |
|---|---|------|---|
| 1 |   | COM  | 1 |
| 2 |   | SUB1 | 2 |
| 3 |   | SUB2 | 3 |
| 4 |   | COM  | 4 |
| 5 |   | SUB3 | 5 |
| 6 |   | SUB4 | 6 |
| 1 |   |      | 1 |
| 2 |   |      | 2 |
| 3 |   | SUB1 | 3 |
| 4 |   | SUB2 | 4 |
| 5 |   |      | 5 |
| 6 |   |      | 6 |
|   | C | D    | E |

- On the E5ER-□4□□, auxiliary outputs 1 to 4 (SUB1 to 4) output to terminals B1 to B6. On the E5ER-□T□□, auxiliary outputs 1 to 2 (SUB1 to 2) output to terminals D3 to D6.

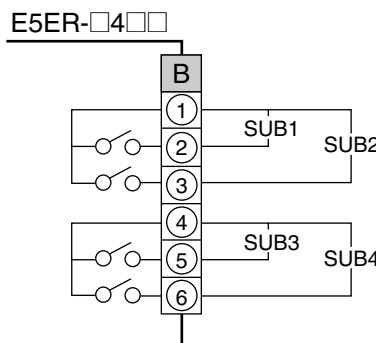

- Relay output specifications are as follows:  
250 V AC 1 A
- On the E5ER-□T□□ auxiliary outputs 1 and 2 (SUB1 and 2) output to terminals D3 to D6.

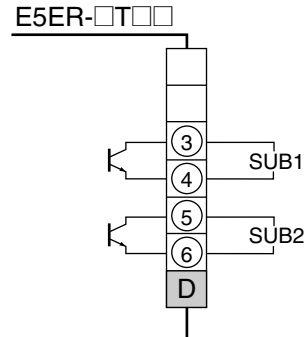

- Transistor output specifications are as follows:  
Max. load voltage 30 V DC  
Max. load current 50 mA  
Residual voltage 1.5 V max.  
Leakage current 0.4 mA max.

**● Potentiometer inputs (terminals)**

E5AR

|   | A | B | C | D | E    |   |
|---|---|---|---|---|------|---|
| 1 |   |   |   |   |      | 1 |
| 2 |   |   |   |   |      | 2 |
| 3 |   |   |   |   |      | 3 |
| 4 |   |   |   |   |      | 4 |
| 5 |   |   |   |   |      | 5 |
| 6 |   |   |   |   |      | 6 |
| 1 |   |   |   |   |      | 1 |
| 2 |   |   |   |   | PMTR | 2 |
| 3 |   |   |   |   |      | 3 |
| 4 |   |   |   |   |      | 4 |
| 5 |   |   |   |   |      | 5 |
| 6 |   |   |   |   |      | 6 |
|   | F | G | H | I | J    | K |

E5ER

|   | A | B    |   |
|---|---|------|---|
| 1 |   |      | 1 |
| 2 |   |      | 2 |
| 3 |   |      | 3 |
| 4 |   |      | 4 |
| 5 |   |      | 5 |
| 6 |   |      | 6 |
| 1 |   |      | 1 |
| 2 |   |      | 2 |
| 3 |   | PMTR | 3 |
| 4 |   |      | 4 |
| 5 |   |      | 5 |
| 6 |   |      | 6 |
|   | C | D    | E |

- If you wish to use a position proportional control type to monitor the amount of valve opening or perform closed control, connect a potentiometer (PMTR) as shown in the following.

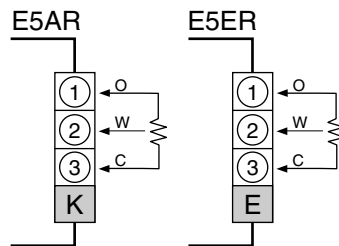

- For information on the potentiometer, see the manual for the valve you are connecting. Terminal number meanings are as follows.  
O:OPEN, W:WIPE, C:CLOSE  
The input range is 100 Ω to 2.5 kΩ (Between C to O).

## ● Event inputs (terminals)

E5AR

|   | A | B | C | D | E   |   |
|---|---|---|---|---|-----|---|
| 1 |   |   |   |   |     | 1 |
| 2 |   |   |   |   | EV3 | 2 |
| 3 |   |   |   |   | EV4 | 3 |
| 4 |   |   |   |   | EV5 | 4 |
| 5 |   |   |   |   | EV6 | 5 |
| 6 |   |   |   |   | COM | 6 |
| 1 |   |   |   |   | EV1 | 1 |
| 2 |   |   |   |   | EV2 | 2 |
| 3 |   |   |   |   | COM | 3 |
| 4 |   |   |   |   |     | 4 |
| 5 |   |   |   |   |     | 5 |
| 6 |   |   |   |   |     | 6 |
|   | F | G | H | I | J   | K |

E5ER

|   | A | B   |   |
|---|---|-----|---|
| 1 |   |     | 1 |
| 2 |   | EV3 | 2 |
| 3 |   | EV4 | 3 |
| 4 |   | EV5 | 4 |
| 5 |   | EV6 | 5 |
| 6 |   | COM | 6 |
| 1 |   | EV1 | 1 |
| 2 |   | EV2 | 2 |
| 3 |   | COM | 3 |
| 4 |   |     | 4 |
| 5 |   |     | 5 |
| 6 |   |     | 6 |
|   | C | D   | E |

- To use event input on the E5AR, connect event inputs 1 and 2 (EV1 and EV2) to terminals K1 to K3, and event inputs 3 to 6 (EV3 to EV6) to terminals numbers E2 to E6. The number of event input points varies depending on the model.

- To use event input on the E5ER, connect event inputs 1 and 2 (EV1 and EV2) to terminals E2 to E3 and event inputs 3 to 6 (EV3 to EV6) to terminals numbers B2 to B6. The number of event input points varies depending on the model.

- The number of input points of each model is as follows:  
 E5AR-□□□B, E5ER-□□□B: 2 points, EV1 and EV2  
 E5AR-□□D□, E5ER-□□D: 4 points, EV3 to EV6  
 E5AR-□□DB: 6 points, EV1 to EV6

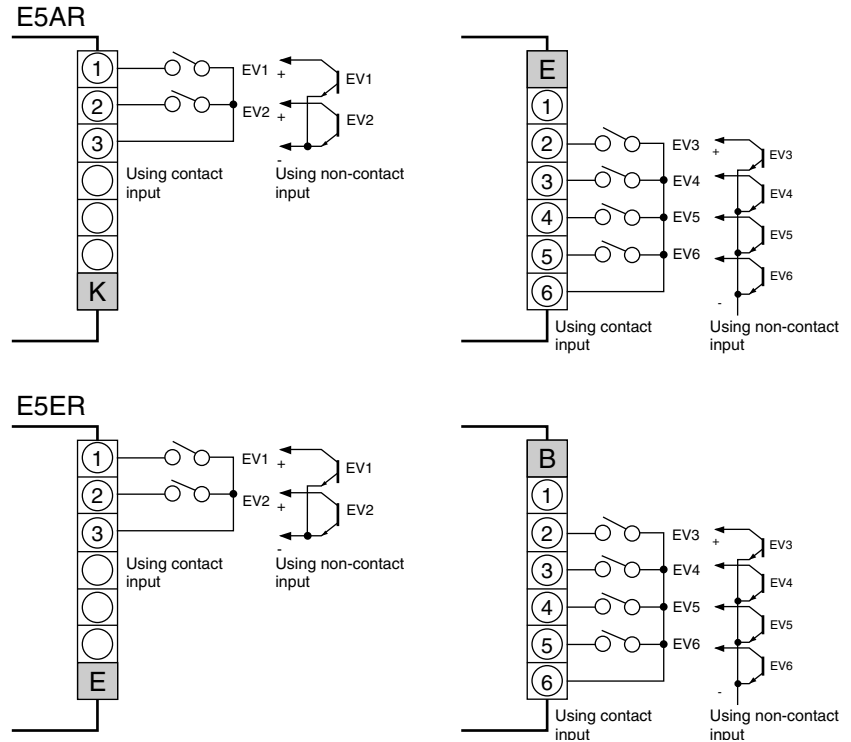

- Input ratings of each input are as follows:

|            |   |
|------------|---|
| Contact    | ON: 1 kΩ max., OFF: 100 kΩ or higher                                    |
| No contact | ON: residual voltage of 1.5 V max., OFF: leakage current of 0.1 mA max. |

<Circuit schematic>

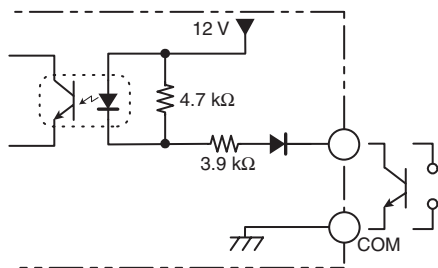

● **Communication (terminals)**

- To communicate with a host system, connect between terminals F1 and F2 on the E5AR, or C1 and C2 on the E5ER.

E5AR

|   |       |   |   |   |   |   |
|---|-------|---|---|---|---|---|
| 1 | A     | B | C | D | E | 1 |
| 2 |       |   |   |   |   | 2 |
| 3 |       |   |   |   |   | 3 |
| 4 |       |   |   |   |   | 4 |
| 5 |       |   |   |   |   | 5 |
| 6 |       |   |   |   |   | 6 |
| 1 | RS485 |   |   |   |   | 1 |
| 2 |       |   |   |   |   | 2 |
| 3 |       |   |   |   |   | 3 |
| 4 |       |   |   |   |   | 4 |
| 5 |       |   |   |   |   | 5 |
| 6 |       |   |   |   |   | 6 |
|   | F     | G | H | I | J | K |

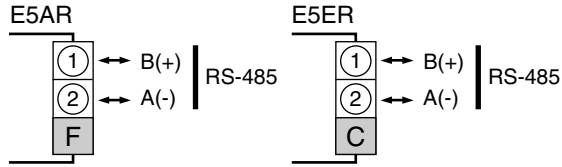

- The connection type is 1:1 or 1:N. In a 1:N installation, up to 32 units, including the host computer, can be connected.
- The maximum total cable length is 500 m.
- Use a shielded twisted pair cable (AWG28 or higher).

<Cable reference diagram>

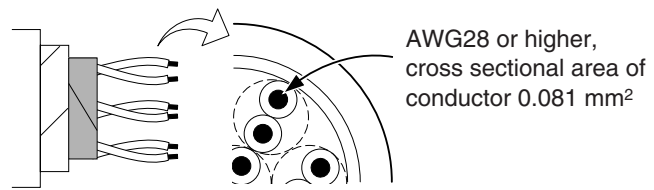

E5ER

|   |       |   |   |  |  |   |
|---|-------|---|---|--|--|---|
| 1 | A     | B |   |  |  | 1 |
| 2 |       |   |   |  |  | 2 |
| 3 |       |   |   |  |  | 3 |
| 4 |       |   |   |  |  | 4 |
| 5 |       |   |   |  |  | 5 |
| 6 |       |   |   |  |  | 6 |
| 1 | RS485 |   |   |  |  | 1 |
| 2 |       |   |   |  |  | 2 |
| 3 |       |   |   |  |  | 3 |
| 4 |       |   |   |  |  | 4 |
| 5 |       |   |   |  |  | 5 |
| 6 |       |   |   |  |  | 6 |
|   | C     | D | E |  |  |   |

- Use a resistance of 100 to 125 Ω (1/2 W) in the terminators. Install terminators at both ends of the transmission path, including the host computer.
- To connect to an RS232C port on a computer, use a 232C-485 convertor.

Example convertor: RS-232C-RS-485 Interface Convertor K3SC

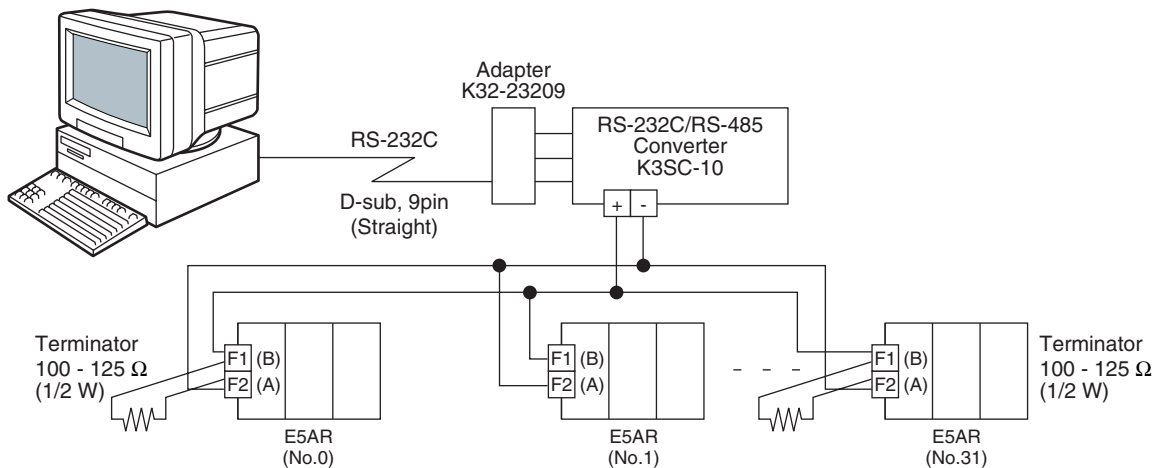



**Insulation blocks** As shown in the following diagram, each function block of the E5AR/ER is electrically insulated.

<Input> <event input · voltage output · current output> <communication> are insulated from each other with functional insulation.

<Input · event input · voltage output · current output · communication> <relay output> <transistor output> are insulated from each other with basic insulation.

If reinforced insulation is required, input, event input, voltage output, current output, and communication terminals must be connected to a device that have no exposed chargeable parts and whose basic insulation is suitable for the applicable maximum voltage of connected parts.

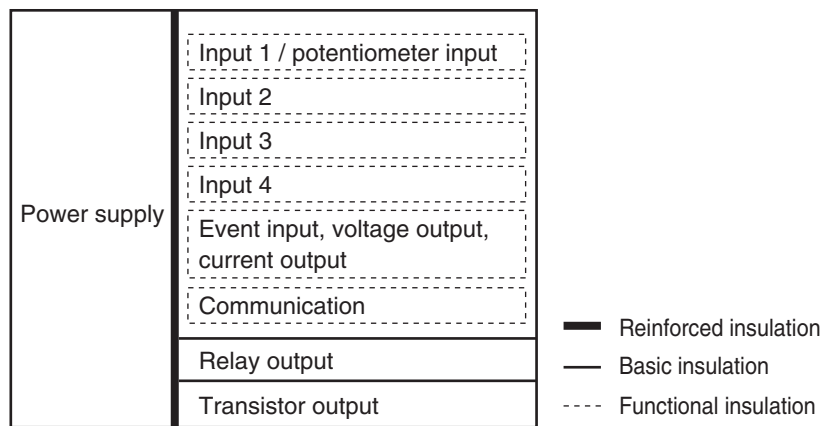

# Section 3 *Typical Control Examples*

|     |   |      |
|-----|---|------|
| 3.1 | Standard control .....                                      | 3-2  |
| 3.2 | Heating/cooling control of a chemical reaction device ..... | 3-5  |
| 3.3 | Position proportional control of a ceramic kiln .....       | 3-9  |
| 3.4 | Cascade control of reflow ovens.....                        | 3-13 |
| 3.5 | Ratio control of dyeing machines.....                       | 3-18 |

### 3.1 Standard control

The following is an example of basic, single-loop control whereby temperature control of a heater plate for semiconductors is carried out (example of combined sensor and heater).

#### Application

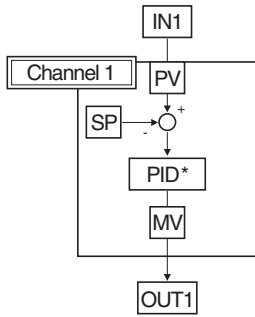

When controlling a heater plater for semiconductor wafers with the E5AR, the control mode is set to standard control and instrumentation is as shown in the following example.

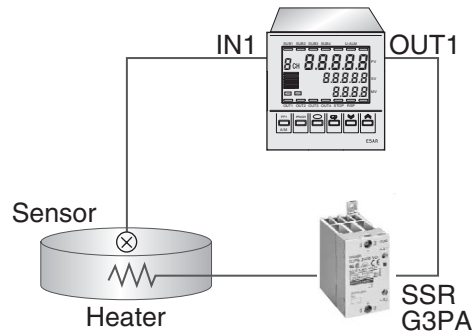

**Hint**

The control period can be set from 0.2 sec to 99.0 seconds on the E5AR/ER. (The shortest setting on our previous models was 1 sec). For high precision control applications that previously required the combined use of our cycle control unit (G32A-EA) and an SSR, the G32A-EA is now no longer needed.

#### Wiring

The platinum resistance temperature input sensor Pt100 is connected to the IN1 terminal, and the OUT1 terminal is connected to the SSR.

Wiring for the E5AR-Q4B is shown in the following schematic.

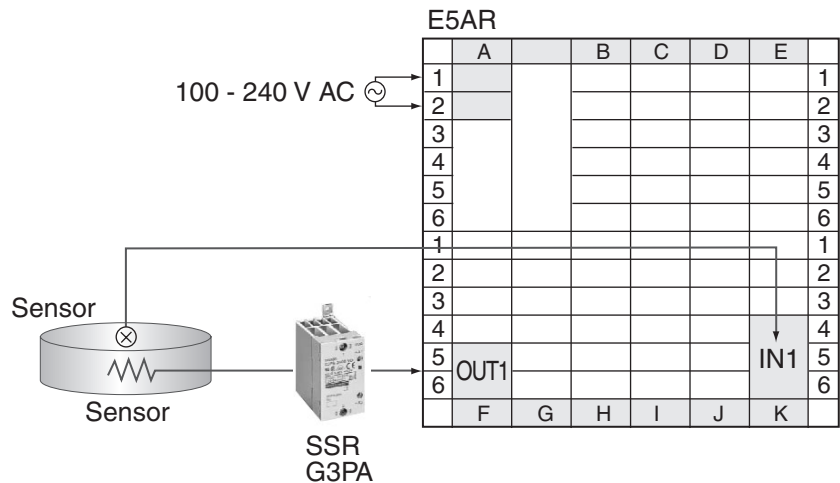

## ■ Settings

Set the control period to 0.2 sec for high-precision temperature control with the SSR.

Related setting data and settings are as follows.

Input 1 type switch = TC. PT (initial setting)

Input 1 input type = 1: Pt100 -150.00 to 150.00°C

Output 1 output type = 0: Pulse voltage output (initial setting)

Control mode = 0: Control mode (initial setting)

Action =  $\bar{a}r-r$ : Reverse action (initial setting)

SP = 115.00(°C)

Control period (heat) = 0.2

The following explains how to set the input type, the output type of output 1, the SP, and the control period (heat), and how to check the control mode.

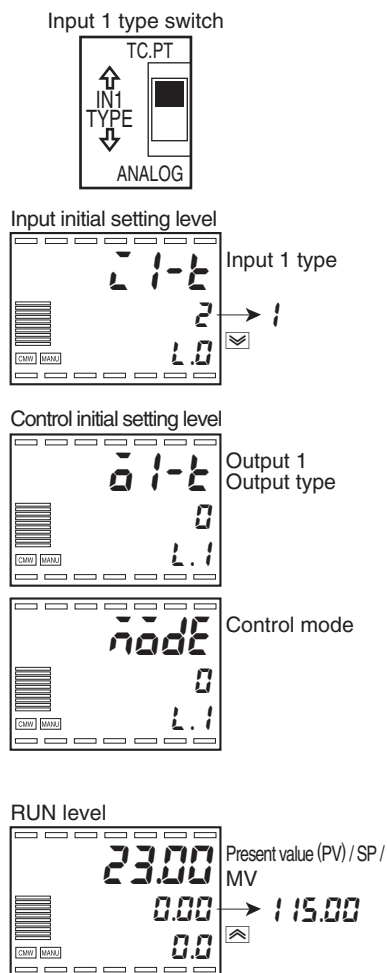

1. Before turning on the power, check that the input 1 type switch is set to TC. PT.
2. Turn on the power and then hold down the  key at least 3 seconds to move from "RUN level" to "Input initial setting level". "1-1: Input 1 input type" will appear. Press the  key to select the setting "1: Pt100 -150.00 to 150.00°C".
3. Press the  key less than 1 second to move from "Input initial setting level" to "Control initial setting level". "0-1: Output 1 Output type" will appear. Check sure that the set value is "0: Pulse voltage output".
4. Press the  repeatedly to select "0-0: Control mode". Check that the setting is "0: Standard control".
5. Hold down the  for at least 1 second to return to "RUN level". "PV/SP/MV" will appear. Press the  key and set the SP to "115.00".

Adjustment level

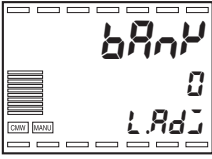

6. Press the  key less than 1 second to move from "RUN level" to "Adjustment level".

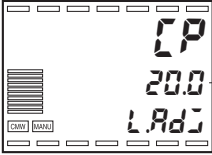

Control period  
(Heat) → 0.2

7. Press the  repeatedly to select "CP: Control period (heat)", and then press the  key to select "0.2".

## ■ Adjustment

To adjust the PID constants, run AT.

For more information, see "4.10 Determining the PID constants (AT, manual settings)" (P.4-20).

**Hint**

If the overshoot of temperature control (disturbance response) is too large after placing the wafer, the overshoot can be adjusted using the disturbance overshoot adjustment function.  
For information on the disturbance overshoot adjustment function. Refer to "5.2 Control functions" (P.5-8).

## 3.2 Heating/cooling control of a chemical reaction device

In temperature control of chemical processes where heat is naturally generated by chemical reactions, heating output and natural cooling are not a sufficient means of control, and thus heating/cooling control is used whereby heating output and cooling output are simultaneously manipulated.

Heating/cooling control is also used for high-precision control of constant-temperature tanks where the temperature is held at a constant level, and for extraction molding where the molding material generates heat.

Heating/cooling control can also be applied to pH control using acids and alkali in liquid mixture systems, and to pressure control where pressure reduction is carried out.

### ■ Application

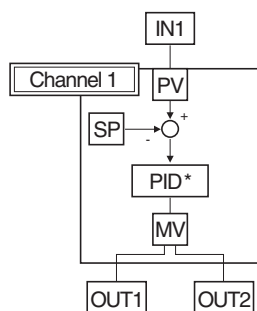

When the E5AR is used to control a chemical reaction device, the control mode is set to heating/cooling control and instrumentation is as shown in the following example.

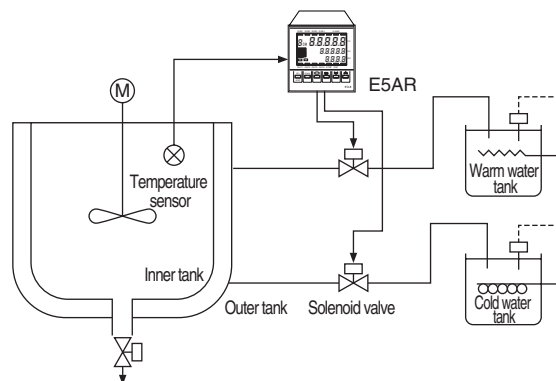

#### Hint

In addition to control of chemical reactions and other processes that naturally generate heat, heating/cooling control is also being increasingly used to shorten heating and cooling cycles for improved production efficiency in batch process production.

Example: Heating/cooling control of a flip chip bonding machine

## ■ Wiring

The input is connected to IN1 according to the input type, the heating system is connected to OUT1, and the cooling system is connected to OUT2.

Wiring for the E5AR-C4B is shown at left.

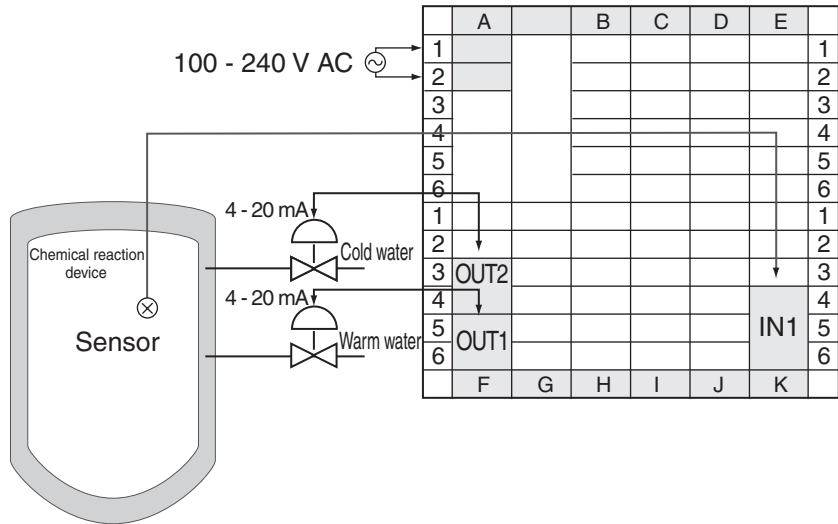

## ■ Settings

When the object has different heating and cooling characteristics, set the cooling coefficient of heating/cooling control to 0.50

Related setting data and settings are as follows:

- Output type of linear current output 1 = 1: 4 to 20 mA (initial setting)
- Output type of linear current output 2 = 1: 4 to 20 mA (initial setting)
- Control mode = 1: Heating/cooling control
- Action =  $\bar{a}r-r$ : Reverse action (initial setting)
- Cooling coefficient = 0.50
- Dead band = 0.00 (°C) (initial setting)

In the following, the control mode, SP, and cooling coefficient are set, and the initial settings are used for the other parameters.

Input initial setting level

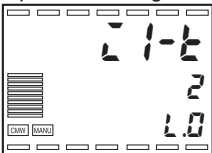

1. Turn on the power and then hold down the  key for at least 3 seconds to move from "RUN level" to "Input initial setting level".

Control initial setting level

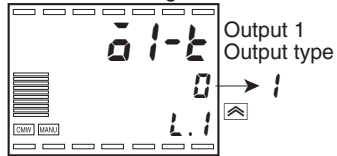

- Press the key for less than 1 second to move from "Input initial setting level" to "Control initial setting level".

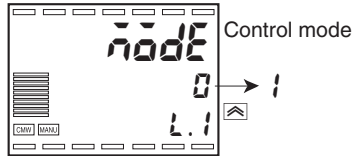

- Press the repeatedly to select "mode: Control mode". Press the key to select "1: Heating/cooling control".

RUN level

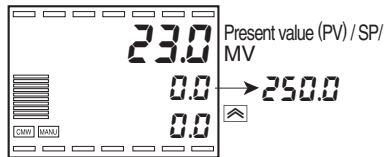

- Hold down the key for at least 1 second to return to "RUN level". "PV/SP/MV" will appear. Press the key to set the value to "250.0".

Adjustment level

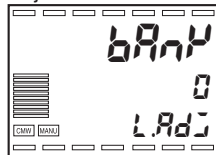

- Press the key less than 1 second to move from "RUN level" to "Adjustment level".

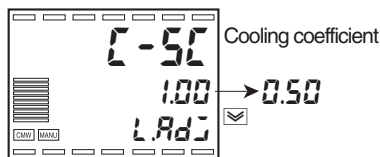

- Press the repeatedly to select "C-5C: Cooling coefficient". Press the key to set the SP to "0.50".

## ■ Adjustment

To adjust the PID constants, run AT.

For more information, see "4.10 Determining the PID constants (AT, manual settings)" (P.4-20).



## ■ Settings for heating/cooling control

When heating/cooling control is selected, the "Dead band" and "Cooling coefficient" settings can be used.

### ● Dead band

The dead band is set centered on the SP. The dead band width is set in "Dead band" in the "Adjustment level". Setting a negative value changes the dead band to an overlap band.

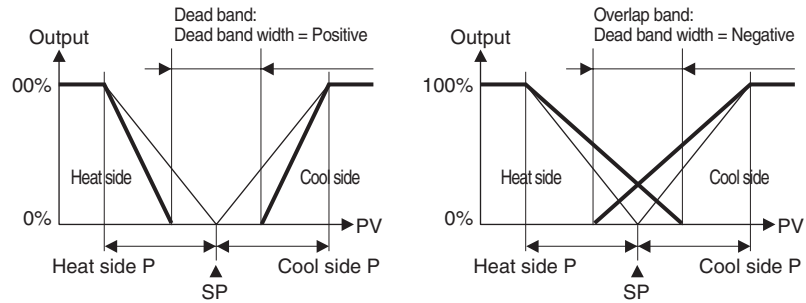

- The initial setting is "0.00".

### ● Cooling coefficient

When the heating characteristics of the object are different from the cooling characteristics and satisfactory control is not possible using the same PID parameters, use the cooling coefficient to adjust the proportional band of cooling control output and thereby balance heating and cooling control. The heating control output P and the cooling control output P are as follows:

$$\text{Heating P} = P$$

$$\text{Cooling P} = \text{Heating P} \times \text{Cooling coefficient}$$

The cooling P is obtained by multiplying the heating P by the cooling coefficient, and cooling output control is performed with different characteristics than heating control output.

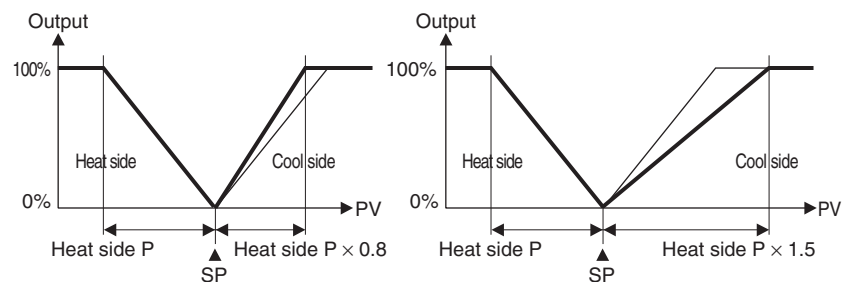

## 3.3 Position proportional control of a ceramic kiln

The control method whereby a potentiometer is used to read the amount of opening of a valve and then open or close the valve by means of an attached control motor is called position proportional control or on/off servo control.

### Application

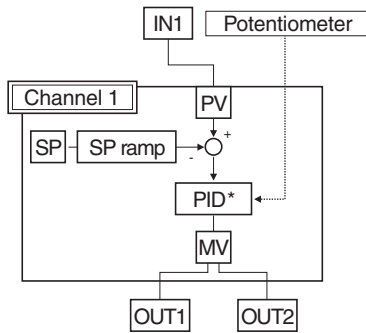

To control a gas kiln using a position proportional control valve, select the control valve control type and configure the instrumentation as shown in the following example.

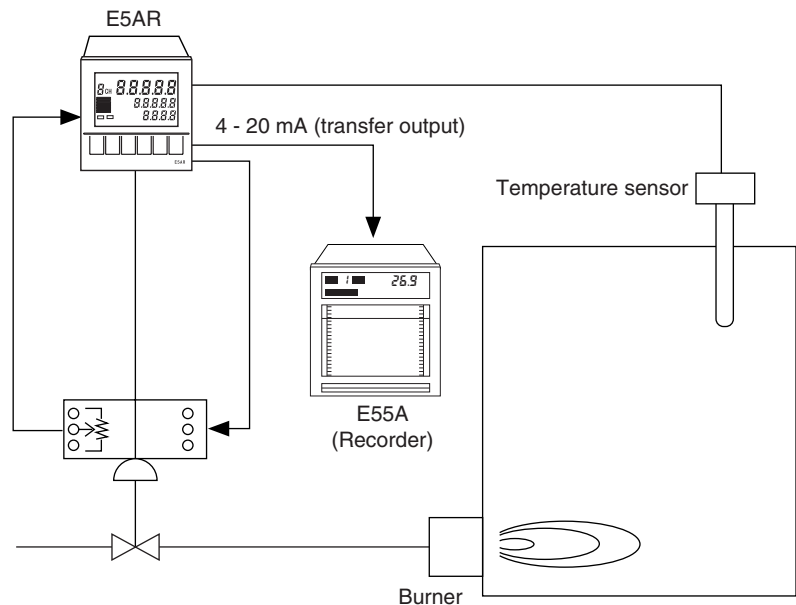
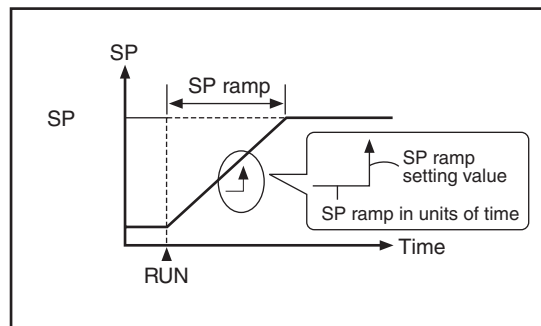

#### Hint

When there is a concern that sudden temperature changes will damage or change the composition of an object such as a ceramic work, the SP ramp function can be used to limit the rate of change of the SP using the SP ramp value and thereby cause the temperature to change at a constant rate.

## ■ Wiring

Connect the input to terminal IN1 according to the input type, connect the open side of the position proportional valve to OUT1, and connect the closed side to OUT2.

When using the E5AR-PR4DF, wire as shown below.

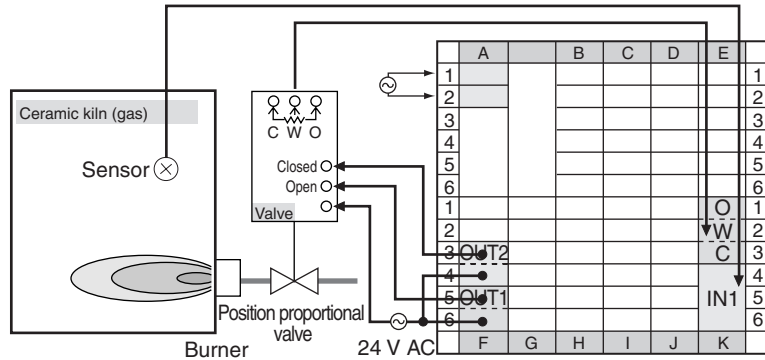

When using floating control, there is no need to connect a potentiometer (C, W, O) unless the amount of valve opening is being monitored.

## ■ Settings

Select the value control type and perform floating control using Position-proportional value with travel time\* of 45 seconds. Set SP ramp to change SP within a width of 10.0 °C / minute.

\*Time from completely open to completely close.

The related setting data and settings are as follows:

Action =  $\bar{a}r-r$ : Reverse action (initial setting)

"Closed/Floating" =  $F\bar{L}\bar{a}R\bar{t}$ : Floating (initial setting)

Travel time = 45 sec

SP ramp time unit =  $\bar{n}$ : min (initial setting)

SP ramp rise value = 10.0 (°C)

The travel time and SP ramp rise value are set in the following, and the initial settings are used for all other parameters.

Input initial setting level

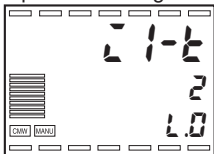

1. Turn on the power and then hold down the  key for at least 3 seconds to move from "RUN level" to "Input initial setting level".

Control initial setting 2 level

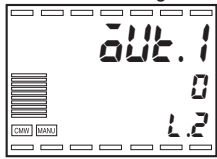
Control / Transfer /  
output assignment

2. Press the  $\square$  twice to move from "Input initial setting level" to "Control initial setting 2 level".

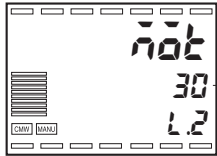

Travel time

3. Press the  $\square$  key repeatedly to select "Travel time". Press the  $\square$  key to set the value to "45".

RUN level

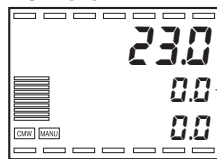
Present value (PV) / SP /  
Valve opening

4. Hold down the  $\square$  at least 1 second to return to "RUN level". "PV/SP/MV" will appear. Press the  $\square$  key to set the SP to "250.0".

Adjustment level

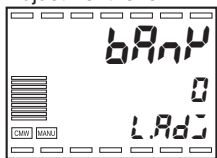

5. Press the  $\square$  key less than 1 second to move from "RUN level to "Adjustment level".

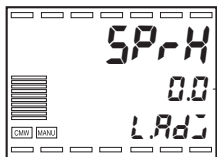

SP ramp rise value

6. Press the  $\square$  key to select "SP ramp rise value", and press the  $\square$  key to set the value to "10.0".

## ■ Adjustment

To adjust the PID constants, run AT.

For more information, see "4.10 Determining the PID constants (AT, manual settings)" (P.4-20).

### Hint

On the E5AR/ER, the SP ramp rise value and the SP ramp fall value can be set separately.

## ■ Settings for position proportional control

When position proportional control is selected, "Closed/Floating", "Motor calibration", "Travel time", "Position proportional dead band", "Open / Close hysteresis", "Operation at potentiometer input error", and "PV dead band" can be used.

### ● Closed/Floating

- Closed control  
Control whereby a potentiometer is connected to feed back the amount of opening of the valve.
- Floating control  
Control without feedback of the amount of opening of the valve. Control is possible without connecting a potentiometer.

### ● Motor calibration and travel time

Run "Motor calibration" when a potentiometer is connected for closed control or floating control that monitors the amount of valve opening.

This will also automatically set the "Travel time", which is the amount of time from when the valve is completely open to when the valve is completely closed.

When performing floating control without a potentiometer, it is necessary to manually set the "Travel time". Set the travel time to the amount of time from when the valve is completely open to when the valve is completely closed.

### ● Position proportional dead band and Open / Close hysteresis

The valve output hold interval (the duration of ON/OFF switching of open output and closed output) is set in "Position proportional dead band", and the hysteresis is set in "Open / Close hysteresis".

The relation to valve opening is shown below.

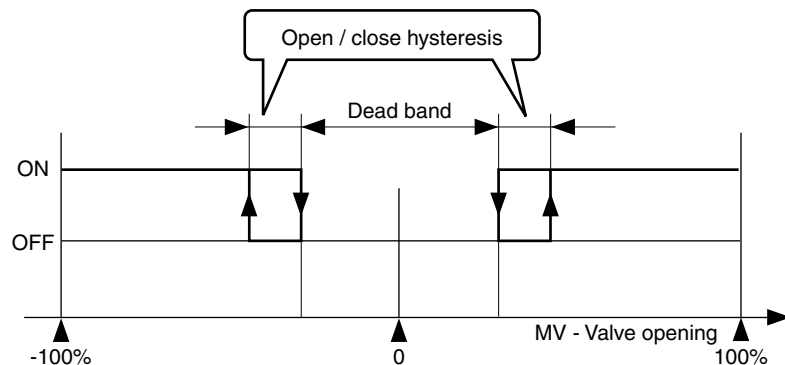

### ● PV dead band

When the present value is inside the PV dead band, this function is used to perform control for  $PV = SP$  and stop unnecessary output when the PV is close to the SP.

### ● Operation at potentiometer input error

Use this setting to select whether to stop control or switch to floating control and continue when a potentiometer error occurs during closed control.

**Important**

In the event that a break occurs in the O or C wires of the potentiometer, potentiometer errors may not be detectable, thus this function (stop control or switch to floating control) does not operate.

## 3.4 Cascade control of reflow ovens

Cascade control is used to reduce the effects of disturbances in the manipulated system (disturbances in the secondary loop) by adding a second PID loop to the regular PID loop.

Cascade control is also used in situations where a sensor is added close to the object to improve control performance.

### ■ Application

Conventional temperature control of reflow ovens is performed using only a sensor installed near the heater. In lead-free reflow ovens, the melting temperature of solder is higher, and in order to minimize heat-induced deterioration of the electronic components, a second sensor is added inside the oven near the board to enable a higher precision of temperature control.

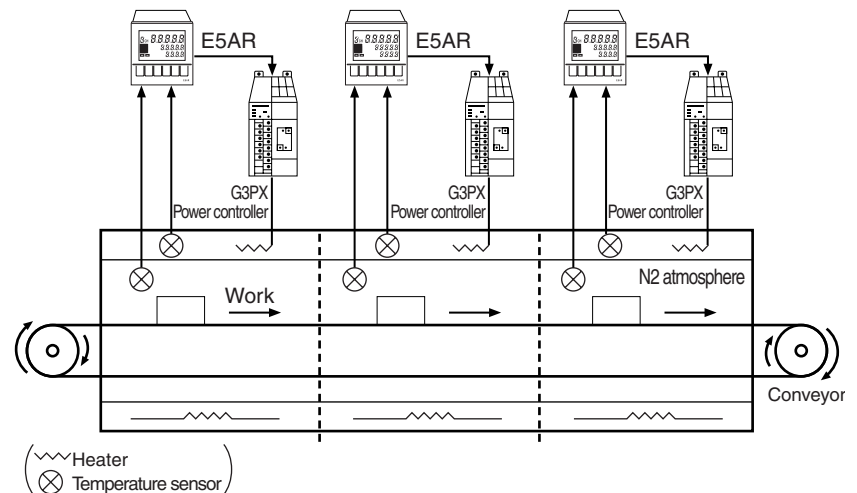

#### Hint

- A thermocouple or platinum resistance temperature input sensor can also be directly connected to input 2 (previously input 2 only supported 4 to 20 mA or 1 to 5 V, and an external converter was required).
- Auto tuning is now possible in both the cascade closed and cascade open states.

## ■ Wiring

Thermocouple K close to the heater is connected to IN2, thermocouple K in the oven is connected to IN1, and a power adjuster is connected to OUT1.

When using the E5AR-QQ43DW-FLK, wire as shown below.

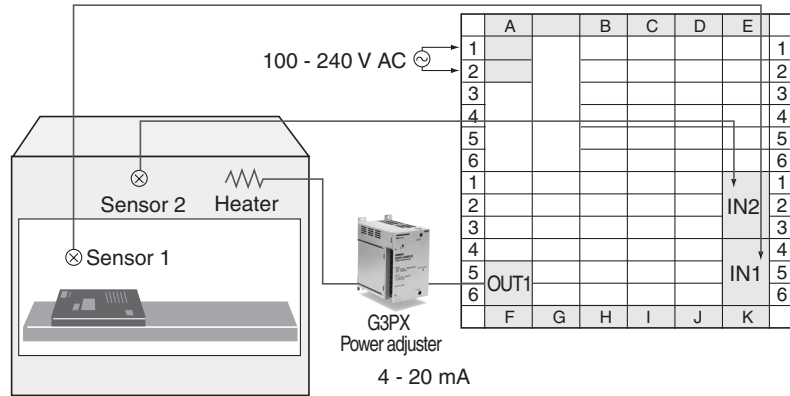

## ■ Settings

Inputs 1 and 2 are set to thermocouple K and the control mode is set to cascade standard control.

The related setting data and settings are as follows:

- Input 1 type switch = TC.PT (initial setting)
- Input 2 type switch = TC.PT (initial setting)
- Input 1 input type = 2: K-200.0 to 1300.0°C (initial setting)
- Input 2 input type = 2: K-200.0 to 1300.0°C (initial setting)
- Output type of output 1 = 1: Linear current output
- Output type of linear current output 1 = 1: 4 to 20 mA (initial setting)
- Control mode = 5: Cascade standard control
- SP = 180.0

The control mode and SP are set in the following, and the initial settings are used for all other parameters.

Input initial setting level

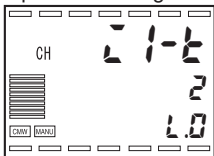

Control initial setting level

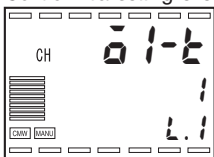

Output 1  
Output type

1. Turn on the power and then hold down the  key for at least 3 seconds to move from "RUN level" to "Input initial setting level".
2. Press the  key less than 1 second to move from "Input initial setting level" to "Control initial setting level". "5 1-t: Output 1 output type" will appear. Press the  key to set to "1: Linear current output".

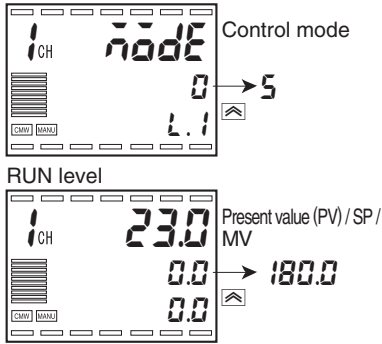

- Press the key repeatedly to select "mode: Control mode". Press the to select "5: Cascade standard control".
- Hold down the at least 1 second to return to "RUN level". "PV/SP/MV" will appear. Press the key to set the SP to "180.0".

## Adjustment

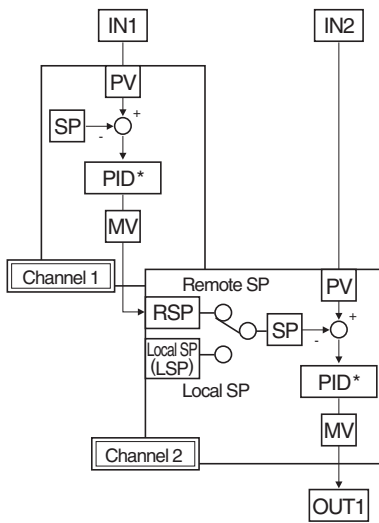

- Run AT in the secondary loop to obtain suitable PID values. When the primary loop achieves stable control close to the SP, set the secondary local SP to the secondary PV. Set the SP mode of channel 2 to local SP mode (cascade open), and with the secondary loop in the independent control state, run AT. When AT finishes, obtain the secondary PID values.
- Set the control mode to cascade control, and run AT on the primary loop to obtain the primary PID values. Set the primary SP to local SP. Set the SP mode of channel 2 to remote SP mode (cascade control), switch to cascade control, and run AT.

When finished, check the primary and secondary control states (PVs) and manually adjust the PID values. Use the same adjustment method as regular PID control.

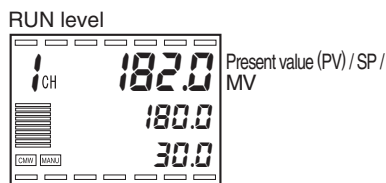

- After the power is turned on, "PV/SP/MV" of the primary loop appears (ch 1). (Here we assume that cascade control is in progress using near SP of 180.0°C)

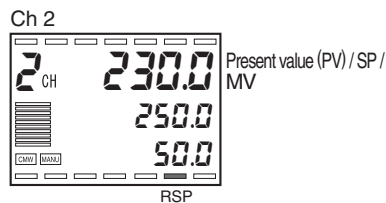

- Press the key to select the secondary (ch 2) "PV/SP/MV". The RSP operation indicator lights on to indicate that the system is in the cascade control (cascade closed) state. (Here we assume that the secondary PV is 230.0°C. The secondary local SP will be set to 230.0°C in step 5.)



Adjustment level (ch 2)

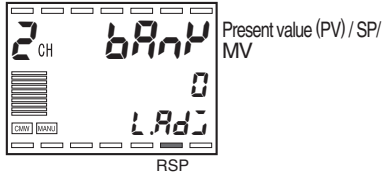

3. Press the key less than 1 second to move from "RUN level" to "Adjustment level".

Ch 2

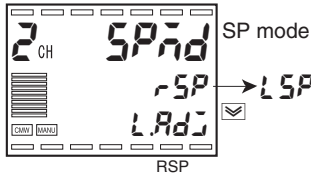

4. Press the key repeatedly to select the secondary (ch 2) "SPAd: SP mode". Press the key to set the SP mode to "LSP: Local SP". The RPS operation indicator is off in local SP mode, indicating independent control (cascade open) in the secondary loop.

RUN level (Ch 2)

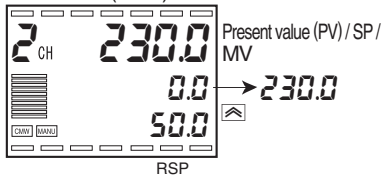

5. Press the key repeatedly to return to "RUN level". The secondary (ch 2) "PV/SP/MV" will appear. Set the secondary SP to "230.0", which is the PV obtained in step 2.

Adjustment level

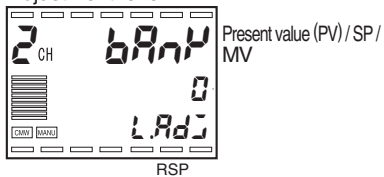

6. Press the key less than 1 second to move from "RUN level" to "Adjustment level".

Ch 2

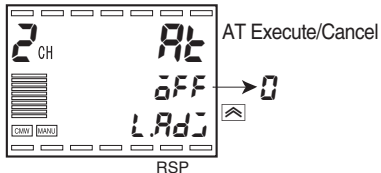

7. Press the key to select the secondary (ch 2) "At: AT Execute / Cancel". Press the key to change the set value to "0" and run AT. During AT the automatically selected PID Set No. is displayed and display 1 (At) blinks. Display 2 shows "oFF" when AT finishes, and display 1 (At) stops blinking.

Ch 2

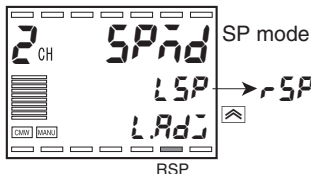

8. Press the key to select the secondary (ch 2) "SPAd: SP mode". Press the key to select "rSP: Remote SP". The RSP operation indicator will light up in remote SP mode to indicate cascade control (cascade closed).

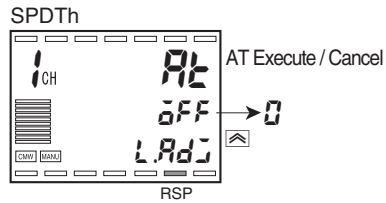

9. Press the **CH** key and then press the **Rt** repeatedly to select "Rt: AT Execute / Cancel" of the primary loop (ch 1). Press the **0** key to change the set value to "0" and run primary AT. During AT the automatically selected PID Set No. is displayed and display 1 (**Rt**) blinks. When AT finishes, display 2 changes to "0FF" and display 1 (**Rt**) stops blinking.

This completes PID adjustment for the primary and secondary loops.

#### Operation when a primary loop input error occurs

When an input error occurs in the primary loop, MV at error is output for the primary (ch 1) MV, and the secondary loop continues control using a remote SP equivalent to the MV at error of the primary loop.

For this reason, be sure to set MV at error for the primary loop.

## 3.5 Ratio control of dyeing machines

Ratio control is used to maintain a constant proportional relationship between two or more variables.

### Application

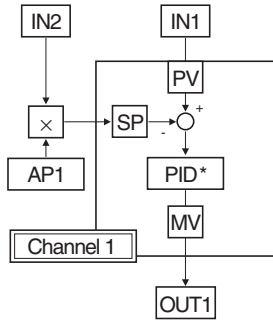

This machine mixes a constant proportion of flowing sand and dye in order to dye the sand a uniform color.

Ratio control that maintains a constant weight ratio between sand and dye

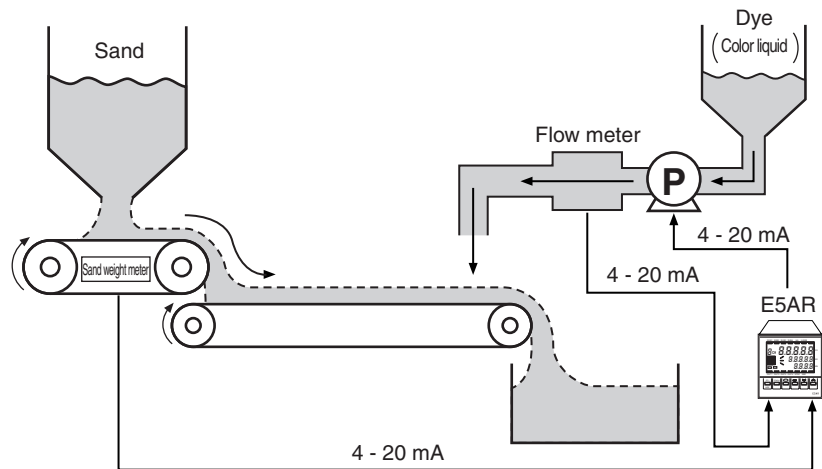

Settings are shown when 4 to 20 mA is used in the input from the dye flow sensor, 4 to 20 mA is used in the input from the sand weight measurement sensor, and a pump is used that is driven by an inverter with a 4 to 20 mA input is used in the manipulation system.

#### Hint

Control of the proportion of gas to air is also carried out in firing control in gas kilns. With the goal of preventing pollution and saving energy, the proportion of gas to air is strictly controlled to prevent incomplete combustion and improve combustion efficiency.

## ■ Wiring

IN1 is connected to the adjustment system and IN2 is connected to the sensor in the reference system. (A flow meter is connected to IN1, a sand weight scale is connected to IN2, and a pump (drive inverter) is connected to OUT1.)

When using the E5AR-QQ43W-FLK, wire as shown below.

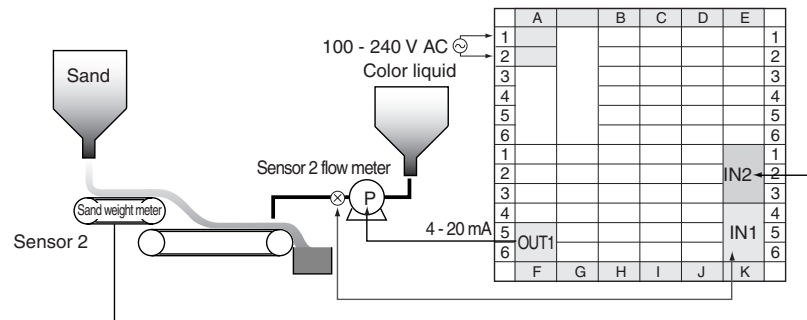

## ■ Settings

The scale of sensor 1, which measures the flow of dye, is 0.0 to 25.0 kg/s, and the scale of sensor 2, which measures the weight of sand, is 0.0 to 500.0 kg/s. The ratio value is set to 0.05 so that the proportion of sand to dye will be 110 : 5.

Related setting data and settings are as follows:

|  |   |
|--|---|
| Input 1 type switch  | = ANALOG                                    |
| Input 2 type switch  | = ANALOG                                    |
| Input 1 type   | = 15: 4 to 20 mA                            |
| Ch 1 scaling input value 1                                   | = 4   |
| Ch 1 scaling display value 1                                 | = 0   |
| Ch 1 scaling input value 2                                   | = 20  |
| Ch 1 scaling display value 2                                 | = 250                                       |
| Ch 1 decimal point position                                  | = 1   |
| Input 2 input type   | = 15: 4 to 20 mA                            |
| Output type of output 1                                      | = 1: Current output (initial setting)       |
| Output type of linear current output 1                       | = 1: 4 to 20 mA (initial setting)           |
| Control mode   | = 4: Ratio control                          |
| Straight-line approximation 1                                | = 0: Enable                                 |
| Straight-line approximation 2                                | = 0: Enable                                 |
| Straight-line approximation 1, Straight-line approximation 2 | → See the setting examples on the next page |
| Analog parameter 1   | = 0.05                                      |
| SP mode  | = 5P: Remote SP                             |

The following explains how to configure the control mode, straight-line approximation 1 and 2 settings, and the ratio setting. It is assumed that the input 1 and input 2 type settings and the scaling setting have already been configured.

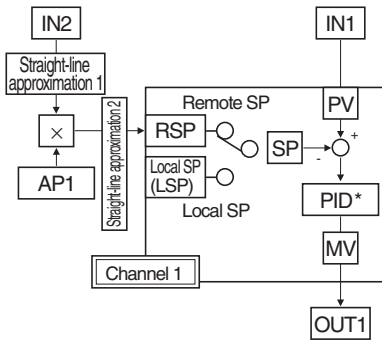

Ratio control is achieved by multiplying input 2 (which serves as a reference) by the proportion and using the result as remote SP.

Set the SP mode to remote SP.

Straight-line approximation 1

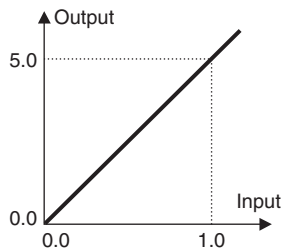

### Straight-line approximation 1

First, to make the units of input 2 match the units of input 1, input 2 is converted from normalized data to an industrial quantity using straight-line approximation 1.

Convert 0.000 - 1.000 to 0 - 5.000.

Straight-line approximation 1 input 1 = 0.000

Straight-line approximation 1 input 2 = 1.000

Straight-line approximation 1 output 1 = 0.000

Straight-line approximation 1 output 2 = 5.000

This result is multiplied by the proportion.

Ratio setting (AP1) = 0.05

Straight-line approximation 2

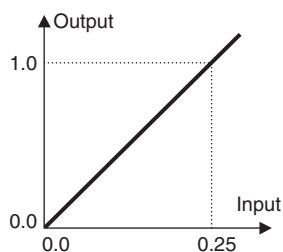

Straight-line approximation 2 is then used to convert this result from an industrial quantity to normalized data.

Straight-line approximation 2 input 1 = 0.000

Straight-line approximation 2 input 1 = 0.250

Straight-line approximation 2 input 1 = 0.000

Straight-line approximation 2 input 1 = 1.000

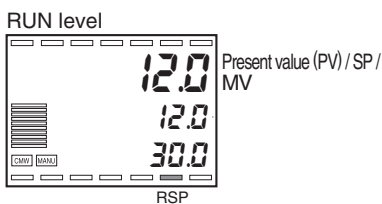

When the ratio setting (AP1) is 0.05 and the measured value of input 2 is 240.0 kg/s, control of the dye takes place using an SP of 12.0 kg/s.

## ■ Adjustment

To adjust the PID constants, run AT.

For more information, see "4.10 Determining the PID constants (AT, manual settings)" (P.4-20).

To change the proportion, change "Proportion setting (AP1)".

### Hint

On the E5AR/ER, use normalized numbers for approximation settings such as broken-line and straight-line approximation.

For example, use 0.200 for 20%. Also, if input 1 is K-200.0 to 1300.0°C, use 0% (0.000) for -200.0°C and 100% (1.000) for 1300.0°C.



# Section 4 *Settings Required for Basic Control*

|      |  |      |
|------|--|------|
| 4.1  | Setting levels and key operation .....                   | 4-2  |
| 4.2  | Set values .....   | 4-4  |
| 4.3  | Initial setting examples .....                           | 4-5  |
| 4.4  | Setting the input type .....                             | 4-8  |
| 4.5  | Selecting the temperature units .....                    | 4-12 |
| 4.6  | Selecting the control mode .....                         | 4-13 |
| 4.7  | Setting output parameters .....                          | 4-14 |
| 4.8  | Setting and changing the SP .....                        | 4-17 |
| 4.9  | Performing ON/OFF control .....                          | 4-18 |
| 4.10 | Determining the PID constants (AT, manual settings)..... | 4-20 |
| 4.11 | Using auxiliary output .....                             | 4-23 |
| 4.12 | Starting and stopping control.....                       | 4-27 |
| 4.13 | Performing manual control.....                           | 4-29 |
| 4.14 | Changing channels.....                                   | 4-31 |
| 4.15 | Operational considerations .....                         | 4-32 |



## 4.1 Setting levels and key operation

The settings are grouped into levels and the set values are called setting data. On the E5AR/ER, the settings are grouped into 17 levels as shown below.

When the power is turned on, all indicators light up for 1 second. The initial level after power-on is "RUN level".

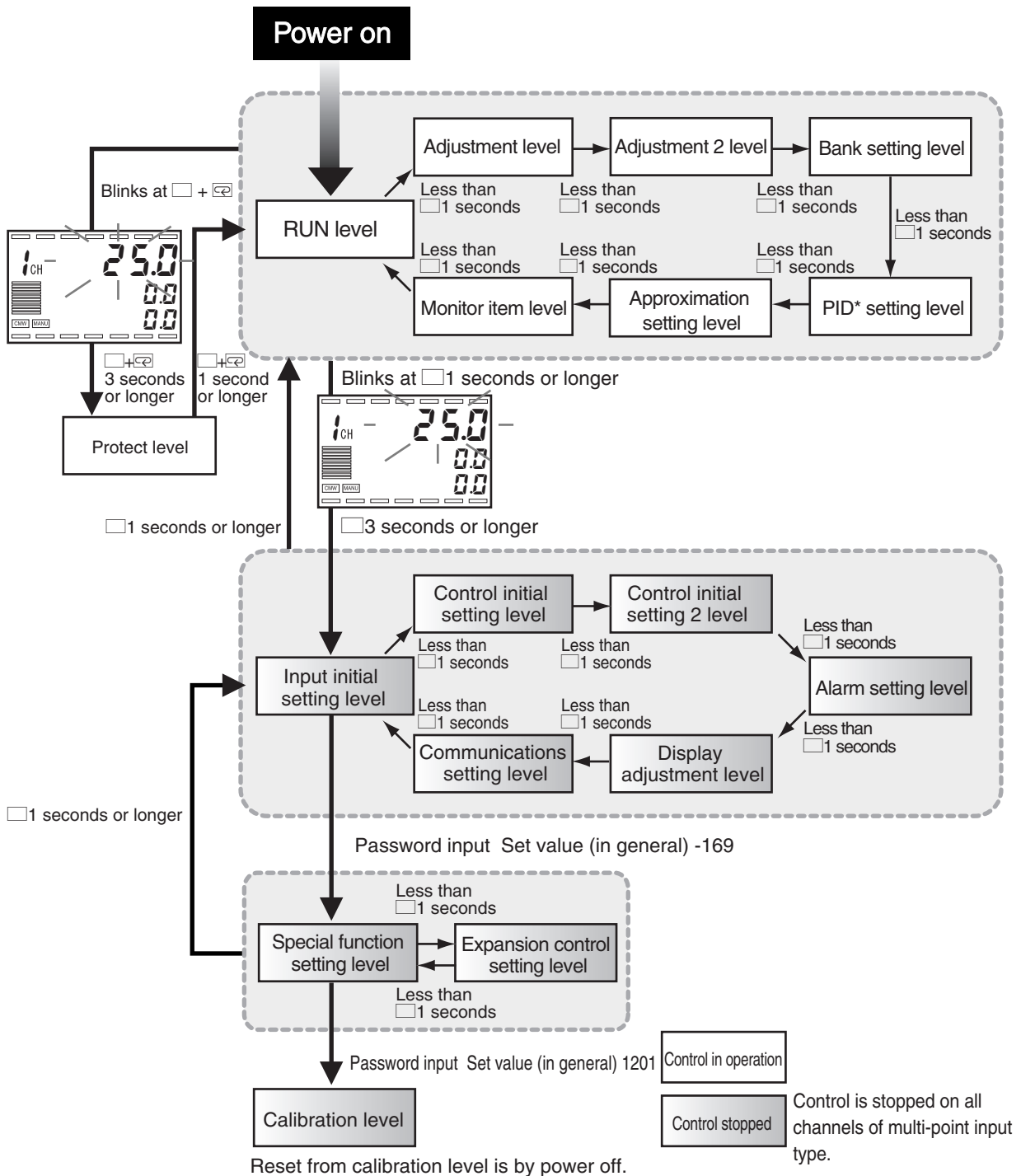

| Level                           | Description  | Operation                 |
|---------------------------------|--|---------------------------|
| Protect level                   | Settings to prevent accidental key input.  | During operation          |
| RUN level                       | Basic display and settings for operation.  |                           |
| Adjustment level                | Option settings and control adjustment.  |                           |
| Adjustment 2 level              | Settings that can be adjusted during operation function control.                   |                           |
| Bank setting level              | SP, PID Set No., and alarm settings of each bank.                                  |                           |
| PID setting level               | P,I,D values of each PID set and limit settings.                                   |                           |
| Approximation setting level     | Broken-line approximation and straight-line approximation settings.                |                           |
| Monitor item level              | Monitor display of set values.   | When operation is stopped |
| Input initial setting level     | Initial settings related to input.   |                           |
| Control initial setting level   | Initial settings for the output type and control mode.                             |                           |
| Control initial setting 2 level | Initial settings for operation functions.  |                           |
| Alarm setting level             | Alarm type and output settings.  |                           |
| Display adjustment level        | Display adjustment settings.   |                           |
| Communications setting level    | Communications speed, communication data length, and other communication settings. |                           |
| Special function setting level  | Initialization of settings and PF key settings.                                    |                           |
| Expansion control setting level | Advanced control settings and position proportional settings.                      |                           |
| Calibration level               | Calibration by the user.   |                           |

\* To move to the special function setting level, set "Initial setting protect" in the "Protect level" to "0".

In following each levels, control is stopped, input initial settings, control initial setting, control initial settings 2, alarm settings, display adjustment, communication settings, advanced function settings, expansion control settings and calibration.

Note that control will stop on all channels if you move to any of these levels.

Display 3 shows the current level. The characters and the corresponding levels are as follows:

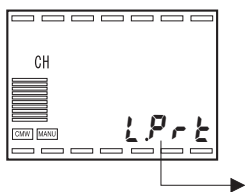

| Display 3 | Level                                   |
|-----------|---|
| LPrE      | Protect level                           |
| Off *     | RUN level                               |
| LAdJ      | Adjustment level                        |
| LAd2      | Adjustment 2 level                      |
| LbnP      | Bank setting level                      |
| LPId      | PID setting level                       |
| LtEC      | Approximation setting level (Technical) |
| Lñõñ      | Monitor item level                      |
| L0        | Input initial setting level             |
| L.1       | Control initial setting level           |
| L.2       | Control initial setting 2 level         |
| L.3       | Alarm setting level                     |
| L.4       | Display adjustment level                |
| L.5       | Communications setting level            |
| LAdF      | Special function setting level          |
| LECC      | Expansion control setting level         |
| LCAL      | Calibration                             |

\* May appear depending on the selected setting data.





## 4.2 Set values

The values selected for each setting are called "set values". There are two types of set values: numbers and characters.

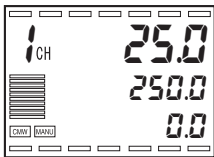
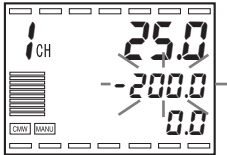
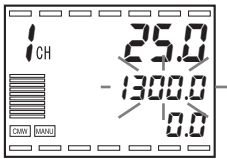
Set values are displayed and changed as follows:

### Changing a numeric set value



1. Press the  key continuously to increase the set value.  
When the upper limit of the setting is reached, the set value will blink and cannot be further increased.
2. Press the  key continuously to decrease the set value.  
When the lower limit of the setting is reached, the set value will blink and cannot be further decreased.
3. Follow steps 1 and 2 to change the set value to the desired value.  
The setting is saved 2 seconds after it is changed, or when a key other than the   keys are pressed.

Note that when setting a manual MV default, the set value is output every 50 ms. The set value is saved as explained above.

## 4.3 Initial setting examples

This section explains how to configure the initial settings for the sensor input type, alarm type, control period, and other parameters. Use the  $\square$  key and  $\square$  key to move through the display screens. The destination screen will vary depending on how long each key is held down.

### ● Typical example

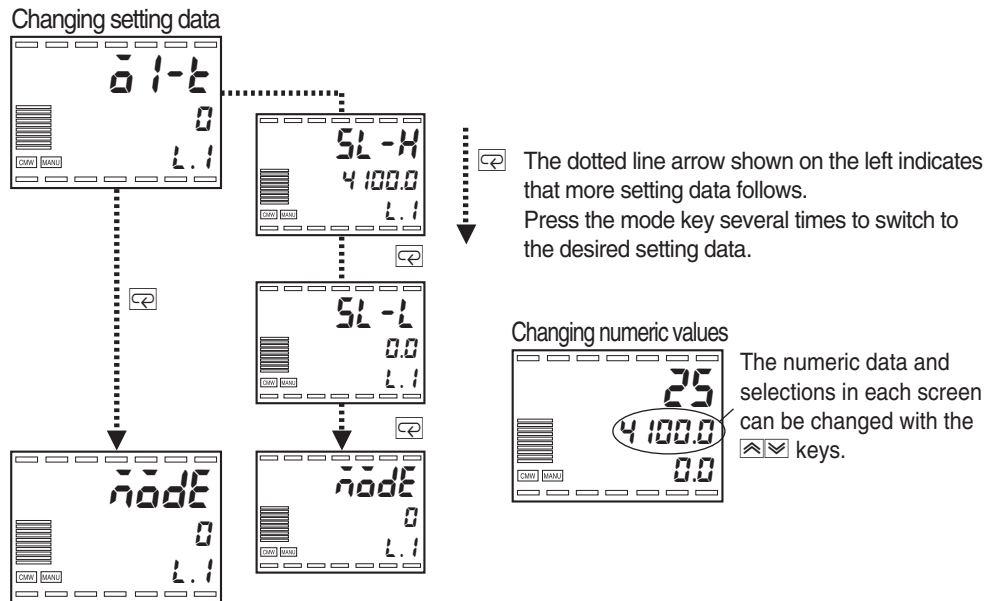

### ● Typical example

E5AR-Q4B  
 Input type: 0 Pt100 (-200.0 to 850.0°C)  
 Control method: PID control  
 Control output: Pulse voltage output  
 Alarm 1 type: 2 upper-limit  
 Alarm value 1: 5.0°C (a deviation is set)  
 Alarm 2 type: 8 absolute-value upper-limit  
 Alarm value 2: 200.0°C  
 PID: Obtained by AT (auto tuning)  
 SP: 150.0°C

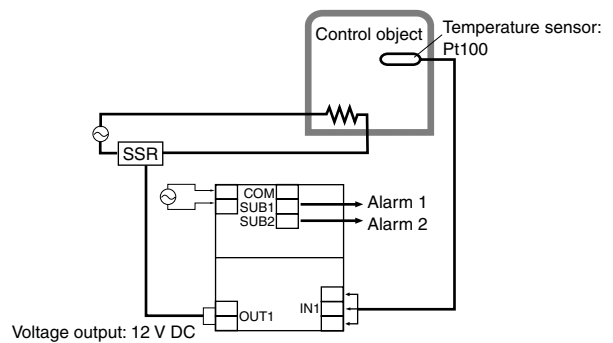

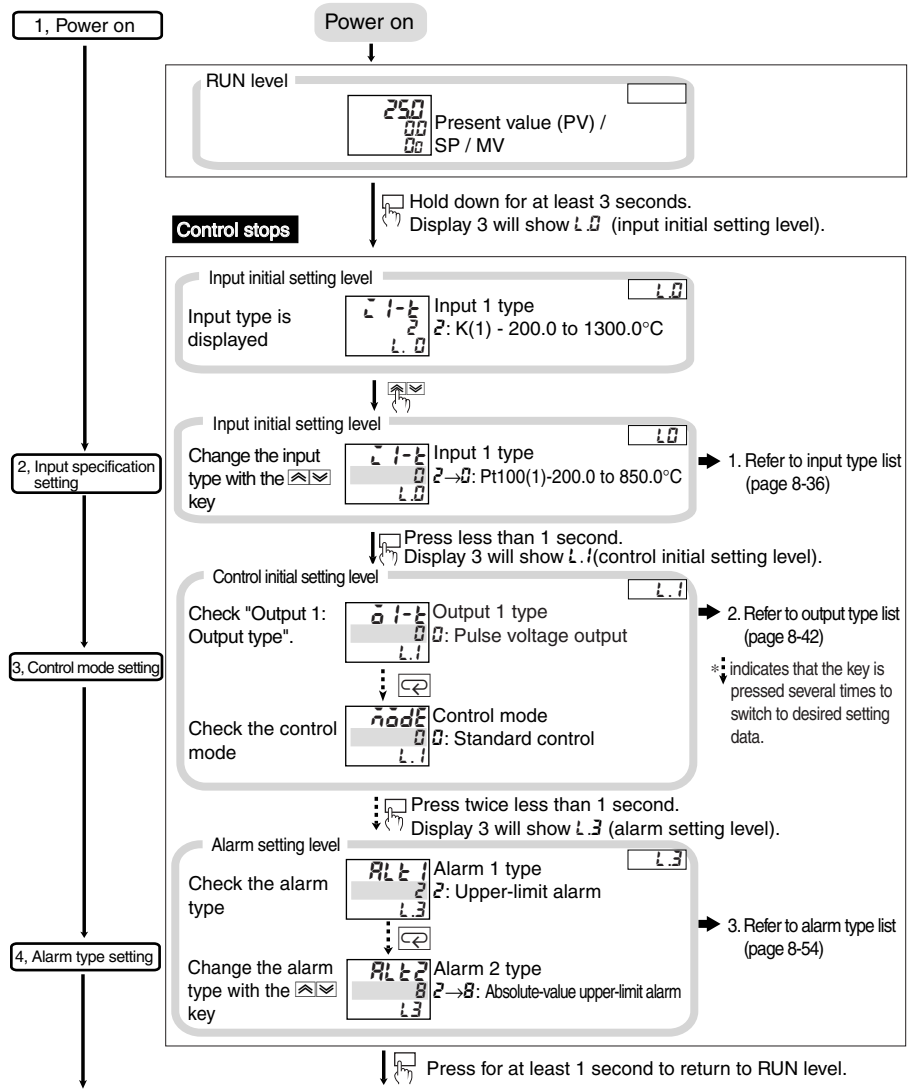

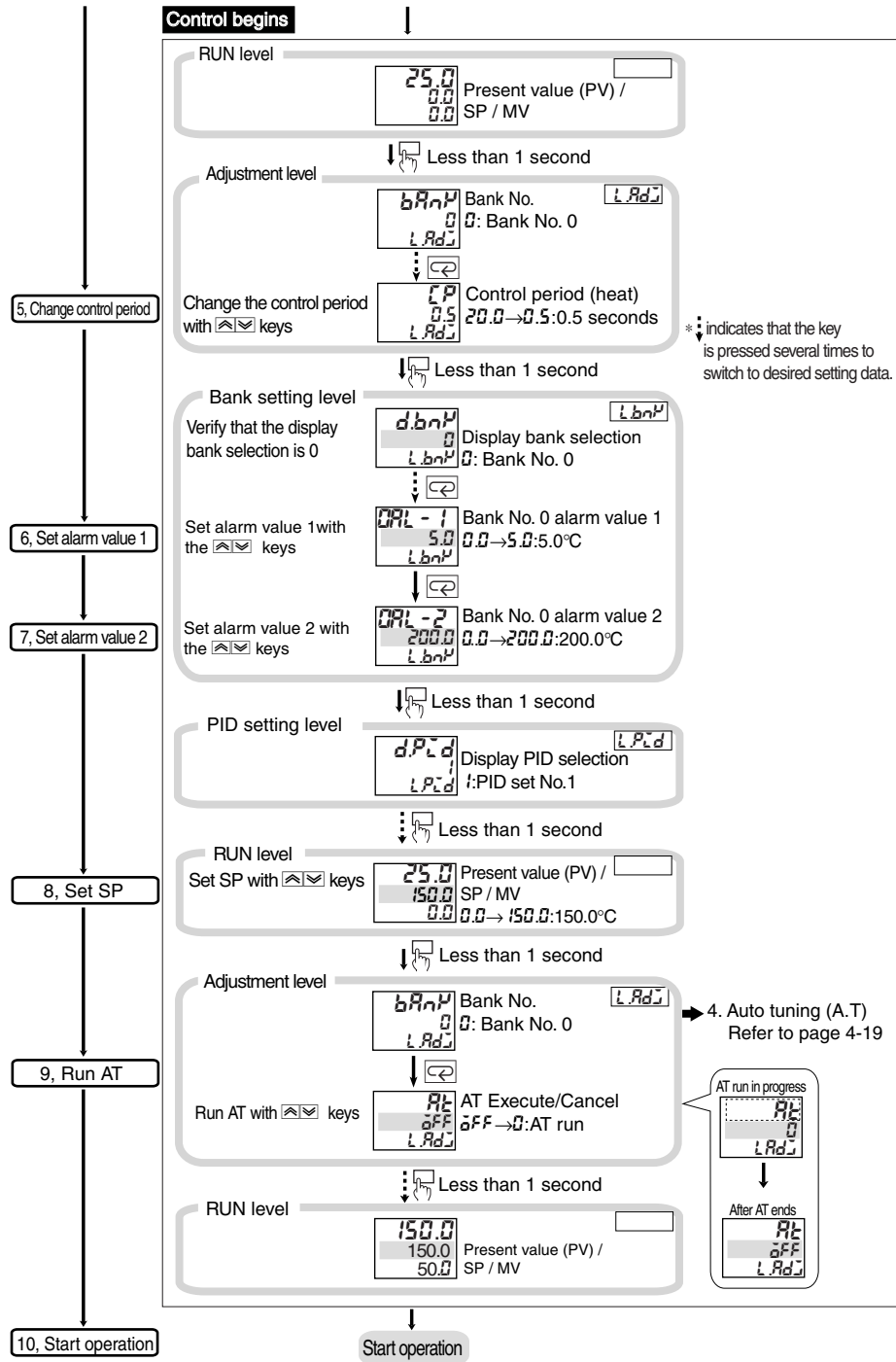

## 4.4 Setting the input type

Set the input type switch and configure the input type setting according to the sensor used. Check the table below and set the correct value for the sensor temperature range to be used.

When using a multi-point input type, set input type switches 2 to 4 and configure input type settings 2 to 4 as appropriate for the number of input points.

### ■ Input type

Setting input 1 to "Platinum resistance temperature input sensor, Pt100, -150.0 to 150.0°C"

Input type SW

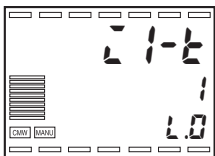
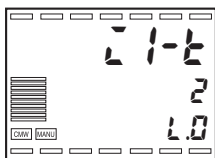
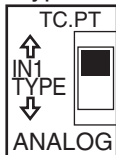

1. Make sure that the input 1 type switch is set to TC.PT and then turn on the power.
2. Hold down the  for at least 3 seconds to move from "RUN level" to "Input initial setting level". The display will show "1-1:Input 1 type".
3. Press the  key to enter the desired sensor value.  
When using a platinum resistance temperature input sensor Pt100 (-150.00 to 150.00°C), set the value to "1".

### Input types

| Set value | Input type | Setting range     |                   | Input type switch   |
|-----------|------------|-------------------|-------------------|---|
|           |            | (°C)              | (°F)              |   |
| 0         | Pt100(1)   | -200.0 to 850.0   | -300.0 to 1500.0  | <p>The diagram shows a rectangular switch labeled 'IN1 TYPE' with an upward-pointing arrow on the left and a downward-pointing arrow on the right. The switch is currently in the 'TC.PT' position, indicated by a black square on the right side of the switch mechanism. The label 'ANALOG' is visible at the bottom of the switch housing.</p> |
| 1         | Pt100(2)   | -150.00 to 150.00 | -199.99 to 300.00 |   |
| 2         | K(1)       | -200.0 to 1300.0  | -300.0 to 2300.0  |   |
| 3         | K(2)       | -20.0 to 500.0    | 0.0 to 900.0      |   |
| 4         | J(1)       | -100.0 to 850.0   | -100.0 to 1500.0  |   |
| 5         | J(2)       | -20.0 to 400.0    | 0.0 to 750.0      |   |
| 6         | T          | -200.0 to 400.0   | -300.0 to 700.0   |   |
| 7         | E          | 0.0 to 600.0      | 0.0 to 1100.0     |   |
| 8         | L          | -100.0 to 850.0   | -100.0 to 1500.0  |   |
| 9         | U          | -200.0 to 400.0   | -300.0 to 700.0   |   |
| 10        | N          | -200.0 to 1300.0  | -300.0 to 2300.0  |   |
| 11        | R          | 0.0 to 1700.0     | 0.0 to 3000.0     |   |
| 12        | S          | 0.0 to 1700.0     | 0.0 to 3000.0     |   |
| 13        | B          | 100.0 to 1800.0   | 300.0 to 3200.0   |   |
| 14        | W          | 0.0 to 2300.0     | 0.0 to 4100.0     |   |

| Set value | Input type | Setting range  |      | Input type switch   |
|-----------|------------|--|------|---|
|           |            | (°C)   | (°F) |   |
| 15        | 4 to 20 mA | One of the following ranges is displayed depending on the scaling<br>-19999 to 99999<br>-1999.9 to 9999.9<br>-199.99 to 999.99<br>-19.999 to 99.999<br>-1.9999 to 9.9999 |      | ANALOG<br> |
| 16        | 0 to 20 mA |  |      |   |
| 17        | 1 to 5 V   |  |      |   |
| 18        | 0 to 5 V   |  |      |   |
| 19        | 0 to 10 V  |  |      |   |

Set the input type switch according to the "Input type" setting.  
The initial settings are "2" and "TC.PT".









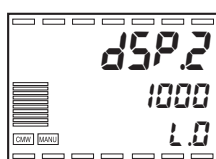
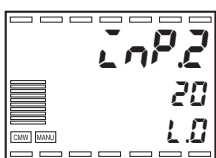
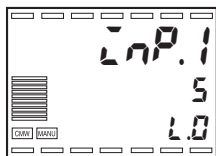
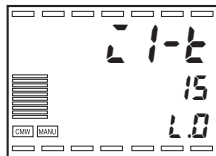
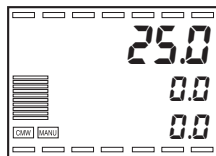



#### Hint

When analog input (voltage input, current input) is used, scaling according to the type of control is possible.

## ■ Scaling

Setting the display to show 0.0 for an input value of 5 mA and 100.0 for 20 mA when the input 1 type is set to "4 to 20 mA".



1. Hold the  key down for at least 3 seconds to move from "RUN level" to "Input initial setting level".
2. Make sure that "I-1: Input 1 input type" is "15: 4 to 20 mA".
3. Press the  key repeatedly to select "I.P.1: Scaling input value 1". Set to "5" with the /  keys.
4. Press the  key to select "dSP.1: Scaling display value 1". Set to "0" with the /  keys.
5. Press the  key to select "I.P.2: Scaling input value 2". Set to "20" with the /  keys.
6. Press the  key to select "dSP.2: Scaling display value 2". Set to "1000" with the /  keys.



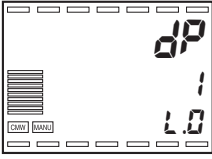

7. Press the key to select "dP: Decimal point position".  
Set to "1" with the keys.

8. Hold down the key for at least 1 second to return to "RUN level".

The scaling setting is configured for each channel. Scaling for inputs 1 to 4 of a multi-point input type corresponds to channels 1 to 4. Select the channel with the CH key and then configure the setting.

| Setting data name       | Attribute | Display       | Setting range                         | Default value | Units       |
|-------------------------|-----------|---------------|---------------------------------------|---------------|-------------|
| Scaling input value 1   | CH        | $\bar{L}nP.1$ | See table below                       | 4             | Table below |
| Scaling display value 1 | CH        | $dSP.1$       | -19999 to scaling display value 2 - 1 | 0             | EU          |
| Scaling input value 2   | CH        | $\bar{L}nP.2$ | See table below                       | 20            | Table below |
| Scaling display value 2 | CH        | $dSP.2$       | Scaling display value 1 + 1 to 99999  | 100           | EU          |
| Decimal point position  | CH        | $dP$          | 0 to 4                                | 0             | -           |

**Setting range and units for each input type**

| Input type | Setting range | Units |
|------------|---------------|-------|
| 4 to 20 mA | 4 to 20       | mA    |
| 0 to 20 mA | 0 to 20       | mA    |
| 1 to 5 V   | 1 to 5        | V     |
| 0 to 5 V   | 0 to 5        | V     |
| 0 to 10 V  | 0 to 10       | V     |

The operation of E5AR/ER control functions and alarms is based on the input values. If a value greater than " $\bar{L}nP.2$ : Scaling input value 2" is set for " $\bar{L}nP.1$ : Scaling input value 1," operation will be as follows for the display value:

- Direct/Reverse Operation  
When direct operation is set, the manipulated variable will increase when the display value decreases.  
When reverse operation is set, the manipulated variable will increase when the display value increases.

**Important**

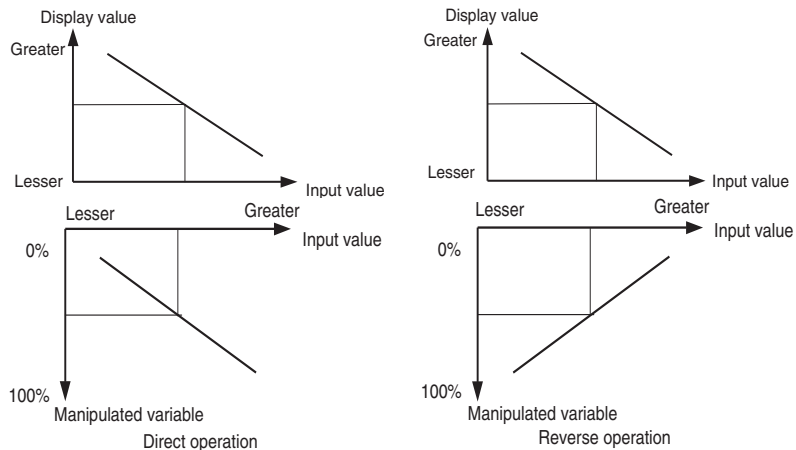

For information on direct and reverse operation, refer to "4.7 Setting output parameters" (P.4-14).

- Alarm

The upper-limit alarm and lower-limit alarm will be inverted. Therefore, set an alarm type and alarm values that invert the upper limit or lower limit of the display value. For example, if an absolute-value upper limit is set for the alarm type, operation will be as shown in the following figure.

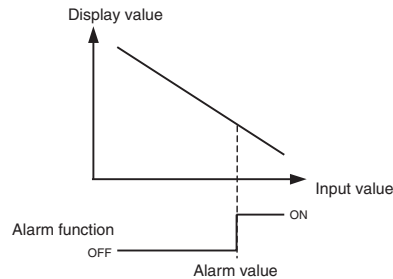

For information on alarms, refer to "4.11 Using auxiliary output" (P.4-23).

- Input Shift

The sign of the input shift value will be inverted. Therefore, set input shift value 1 and input shift value 2 to values that invert the sign of the display value.

For information on input shift, refer to "5.1 Input adjustment functions" (P.5-2).

- SP Ramp

The rise and fall of the ramp will be inverted. Therefore, set the rising direction of the display value for the "SP ramp fall value" and the falling direction of the display value for the "SP ramp rise value."

For information on the SP ramp, refer to "5.2 Control functions" (P.5-8).

- PID Set Automatic Selection

If "PID set automatic selection data" is set to PV, set the "PID set automatic selection range upper limit" so that the set values decrease for the PID set numbers in ascending order as shown in the following figure.

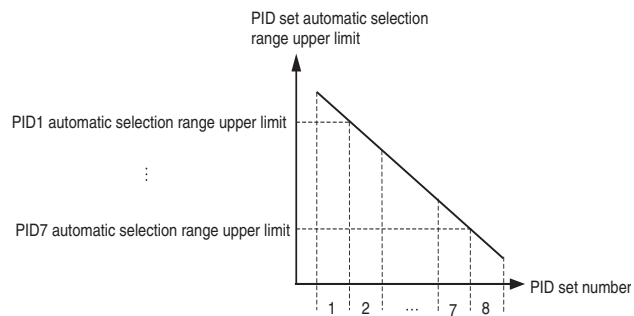

If "PID set automatic selection data" is set to DV, the DV used when performing auto-select will be inverted.

For information on PID set automatic selection, refer to "5.2 Control functions" (P.5-8).

Important

## 4.5 Selecting the temperature units



When the input type is set to temperature input (input from a thermocouple or a platinum resistance temperature input sensor), "°C" or "°F" can be selected for the temperature units.

When using a multi-point input type, set the temperature units separately for each input (2 to 4) as appropriate for the number of inputs.

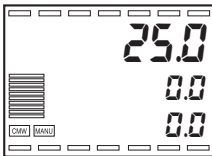
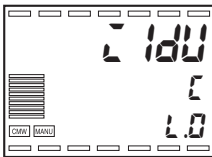
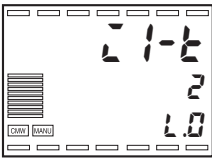
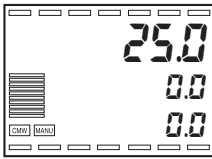
### Selecting "°C"



1. Hold the  key down for at least 3 seconds to move from "RUN level" to "Input initial setting level".

2. Press the  key to select "21.0U: Input 1 Temperature units".  
Select "°C"/"°F" with the  key.

 : °C     : °F

3. Hold the  key down for at least 1 second to return to "RUN level".

## 4.6 Selecting the control mode

The control mode allows various types of control to be performed.

The control mode is initially set to standard control.

- **Standard control**
  - Performs standard heating or cooling control. The "Direct/reverse operation" setting is used to select heating (reverse action) or cooling (direct action).
  - When using PID control, the "Proportional band (P)", "Integral time (I)", and "Derivative time (D)" settings must be configured. These PID constants can be set using AT (Auto-tuning) or manually.
  - When the proportional band (P) is set to 0.00%, control becomes ON/OFF control.
- **Heating/cooling control**
  - Performs heating and cooling control
  - When using PID control, in addition to the "Proportional band (P)", "Integral time (I)", and "Derivative time (D)" settings, the "Cooling coefficient" and "Dead band" settings must be configured. The PID constants can be set using AT (Auto-tuning) or manually, while the "Cooling coefficient" and "Dead band" must be set manually.
  - When the proportional band (P) is set to 0.00%, control becomes ON/OFF control and 3-position control is possible.

The following control modes can only be selected on 2-input types.

- **Standard control with remote SP**
  - An external DC current or voltage signal is input into the remote SP input (input 2), and standard control is performed using the remote SP input as the SP.
  - Input 2 can be used within the permitted setting range determined by the input 2 type.
- **Heating/cooling control with remote SP**
  - An external DC current or voltage signal is input into the remote SP input (input 2), and heating/cooling control is performed using the remote SP input as the SP.
  - Input 2 can be used within the permitted setting range determined by the input 2 type.
- **Ratio control**
  - Ratio control is used to maintain a set proportional relationship between two variables.
- **Cascade standard control**
  - Cascade control is performed using standard control.
  - Input 1 is for the primary loop (ch1) and input 2 is for the secondary loop (ch2).
- **Cascade heating/cooling control**
  - Cascade control is performed using heating/cooling control.
  - Input 1 is for the primary loop (ch1) and input 2 is for the secondary loop (ch2).

## 4.7 Setting output parameters

### ■ Control period

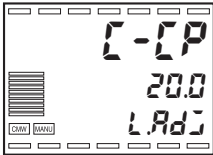
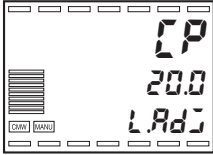

- The output period (control period) must be set. A shorter control period improves controllability, however, when a relay is used to control a heater, a control period of at least 20 seconds is recommended to preserve product life. After setting the control period in the initial settings, readjust it as necessary using trial runs.
- Set the values in "CP: Control period (heat)" and "C-CP: Control period (cool)". The default value is "20.0 sec".
- "Control period (cool)" can only be used in heating/cooling control.
- When each channel is used independently for control, set the control period separately for each channel.

### ■ Direct operation (cool) / Reverse operation (heat)

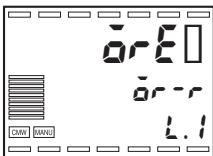
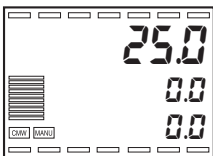

- Control that increases the MV as the PV increases is called direct operation (cool), and control that increases the MV as the PV decreases is called reverse operation (heat).

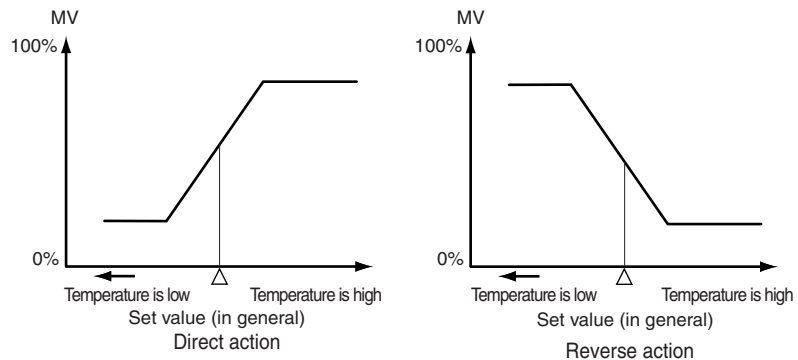

- For example, when the present value (PV) is less than the set point (SP) during heating control, the manipulated valuable (MV) is increased in proportion to the difference between the PV and SP. As such, heating control is "reverse operation". Cooling control, which does the opposite, is "direct operation".
- Set "Direct / reverse operation" to "dr-r: Reverse operation" or "dr-d: Direct operation". The initial setting is "Reverse operation (heat)".
- When each channel is used independently for control, set the direct / reverse operation separately for each channel.

## Output type

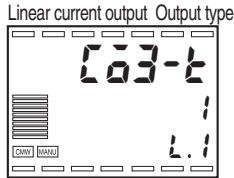
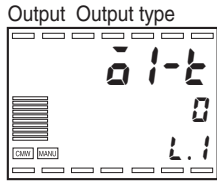

- Multi-output is available on the E5AR/ER, which allows selection of pulse voltage output or linear current output. Select the output type in "Output\*: Output type".  
The E5AR-Q□□□□, output 1 of the E5ER-Q□□□□, and outputs 1 and 3 of the E5AR-QQ□□ are multi-outputs.
- Linear current output can be set to 4 to 20 mA or 0 to 20 mA in "Linear current output\*: Output type".
- Pulse voltage output is 12 V DC, 40 mA.

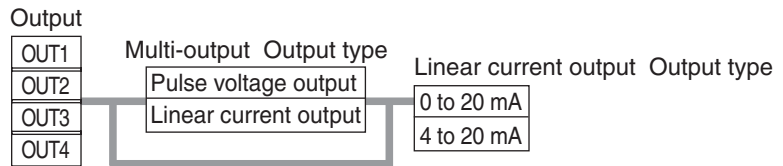

## Output assignment

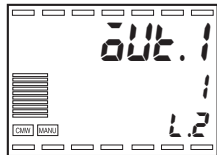

- This is used to assign what type of data is output from each output.
- On multi-point input types, the data assignment can be set for channels 2 and higher as appropriate for the number of channels.

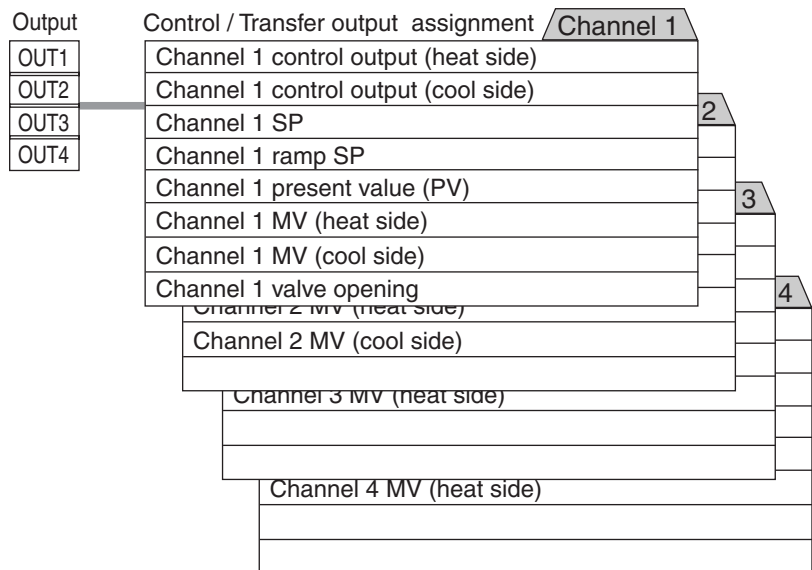



- When used for control output, the assignments are made automatically based on the control mode setting as shown on the following page. There is no need to change the assignments.
- To use an output for transfer output, assign the data you wish to transfer to an unused output.  
Note that if transfer output is assigned to a pulse voltage output, the output will turn OFF.

| Control mode                           | 1-input type | 2-input type                             | 4-input type | Out-put      | Control / Transfer output assignment  |
|--|--------------|--|--------------|--------------|---|
| Standard control                       | IN1          | IN1                                      | IN1          | OUT1         | Channel 1 control output (heating side)   |
|  |              | IN2                                      | IN2          | OUT2         | Channel 2 control output (heating side)   |
|  |              |  | IN3          | OUT3         | Channel 3 control output (heating side)   |
|  |              |  | IN4          | OUT4         | Channel 4 control output (heating side)   |
| Heating/cooling control                | IN1          | IN1                                      | IN1          | OUT1         | Channel 1 control output (heating side)   |
|  |              |  |              | OUT2         | Channel 1 control output (cooling side)   |
|  |              | IN2                                      | IN2          | OUT3         | Channel 2 control output (heating side)   |
|  |              |  |              | OUT4         | Channel 2 control output (cooling side)   |
| Standard control with remote SP        |              | IN1<br>IN2: Remote SP                    |              | OUT1         | Channel 1 control output (heating side)   |
| Heating/cooling control with remote SP |              | IN1<br>IN2: Remote SP                    |              | OUT1<br>OUT2 | Channel 1 control output (heating side)<br>Channel 1 control output (cooling side)                              |
| Ratio control                          |              | IN1<br>IN2: Ratio setting                |              | OUT1         | Channel 1 control output (heating side)   |
| Cascade standard control               |              | IN1: Primary loop<br>IN2: Secondary loop |              | OUT1         | Channel 2 control output (heating side)   |
| Cascade heating/cooling control        |              | IN1: Primary loop<br>IN2: Secondary loop |              | OUT1<br>OUT2 | Channel 2 control output (heating side)<br>Channel 2 control output (cooling side)                              |
| Position proportional control          | IN1          |  |              | OUT1<br>OUT2 | Channel 1 control output (open)<br>*Cannot be changed<br>Channel 1 control output (close)<br>*Cannot be changed |

## 4.8 Setting and changing the SP

### ■ Setting and changing the SP

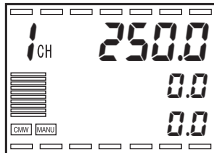

- When "Operation adjustment protect" is set to "4" and "Setting change protect" is set to "ON", the SP cannot be changed. For more information, see "5.5 Protecting settings" (P.5-24).
- To change the SP, press the   keys in "PV/SP" (RUN level) to select the desired value. The new setting becomes effective 2 seconds after the change.
- The bank function can be used to switch through as many as eight SPs. For more information, see "5.2 Control functions ■ Banks" (P.5-9).

Changing the SP from a temperature of 0.0°C to 150.0°C

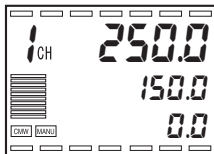

1. The display normally shows "PV/SP". The SP is "0.0" °C.



2. Use the   keys to set the SP to "150.0".



## 4.9 Performing ON/OFF control

ON/OFF control consists of setting an SP and then having the control output turn off when the temperature reaches the SP during control. When the control output turns off, the temperature begins to fall, and once it falls to a certain point the control output turns on again. This action is repeated around a certain position. ON/OFF control requires setting "Hysteresis (heat)" to the temperature drop from the SP at which it is desired that the control output turn on. The "Direct/reverse operation" setting is used to determine whether the MV is increased or decreased with respect to an increase or decrease of the PV.

### ■ ON/OFF Control

- On the E5AR/ER, switching between advanced PID control and ON/OFF control is accomplished using the proportional band setting. When the proportional band is set to "0.00", ON/OFF control is performed, and when it is set to any value except "0.00", advanced PID control is performed. The initial setting is "10.00".

#### ● Hysteresis

- In ON/OFF control hysteresis is added when switching between ON and OFF to stabilize operation. The width of hysteresis is called the "Hysteresis". The hysteresis is set for both heating and cooling control output using the "Hysteresis (heat)" and "Hysteresis (cool)" settings.
- For standard control (heating or cooling control), only the "Hysteresis (heat)" setting is used, regardless of whether heating or cooling is being performed.

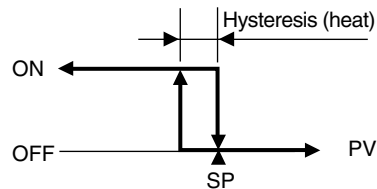

#### ● 3-position control

- For heating/cooling control, an area (dead band) can be set where the MV is 0 for both heating and cooling. This means that 3-position control can be performed.

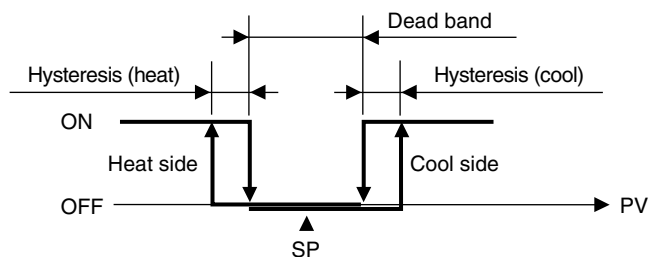

## ■ Settings

### ON/OFF control settings (Proportional band P=0.00)

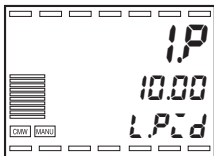
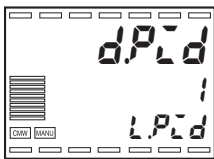
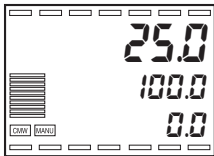

### Setting the hysteresis

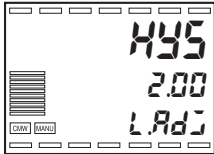
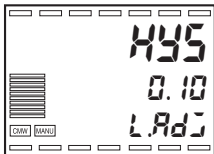
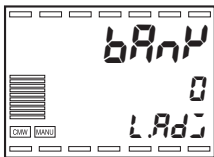
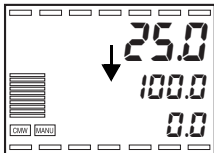

To perform ON/OFF control, the "SP", "Proportional band", and "Hysteresis (heat)" settings must be configured.

Setting ON/OFF control and an hysteresis (heat) of 2.00%FS

Set "Proportional band to "0.00" in "PID setting level" to select ON/OFF control.

1. Press the  key repeatedly (less than 1 second each time) to move from "RUN level" to "PID setting level".

2. "Display PID selection" appears in "PID setting level". If a PID Set No. will not be used, use the initial setting "1". If a PID Set No. will be used, select the PID Set No. for the desired control.

3. Press the  key to display the "Proportional band" used for control. Use the /  keys in this display to set the value to "0.00".

4. Press the  key repeatedly less than 1 second each time to return to "RUN level".

Setting "Hysteresis (heat)" to "2.00" in "Adjustment level"

1. Press the  key less than 1 second to move from "RUN level" to "Adjustment level".

2. "Bank No." appears in "Adjustment level".

3. Press the  key repeatedly to select "Hysteresis (heat)".

4. Use the /  keys to set the value to 2.00.

5. Press the  key repeatedly (less than 1 second each time) to return to "RUN level".

## 4.10 Determining the PID constants (AT, manual settings)

### ■ AT (Auto-tuning)

- When AT is run, the most suitable PID constants for the current SP are automatically set. This is accomplished by varying the MV to obtain the characteristics of the object of control (limit cycle method).
- AT cannot be run during STOP or in manual mode.
- When running AT, select "0" to run AT for the PID set currently being used for control, or select "1" to "8" as appropriate to run AT for a specific PID set.
- The results of AT will be reflected in "PID setting level" in the "Proportional band (P)", "Integral time (I)", and "Derivative time (D)" of the PID Set No. specified at the time AT was run.

#### ● Explanation of AT operation

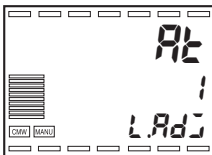
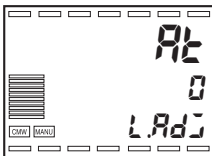
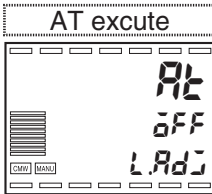

AT begins when "AT Execute/Cancel" is changed from "OFF" to "0".

While AT is running, "AT Execute/Cancel" blinks in Display 1. Display 2 shows the PID Set No. currently being used for control. When AT ends, "AT Execute/Cancel" goes off and the display stops blinking.

AT runs and the displays show the following;  
 Display 1: Blinking display indicating AT is running.  
 Display 2: Shows selected PID Set No..

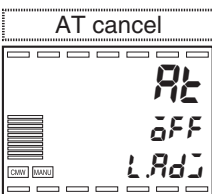

To stop AT, select "OFF: AT stop".

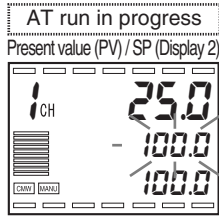

If you attempt to move to "RUN level" and show "PV/SP" while AT is running, Display 2 will blink and indicate that AT is running.

- Only "Write via communication", "Run/Stop", "AT Execute/Cancel", and "Auto/Manual" can be changed while AT is running. No other settings can be changed.
- If "Run/Stop" is set to "Stop" while AT is running, AT will stop and operation will stop. If "Run" is then selected, AT will not resume.
- If an input error occurs while AT is running, AT will stop. AT will run again after recovery from the error.
- If AT is started during SP ramp, AT will run for the ramp SP.

## ● Limit cycle

The timing for generating a limit cycle varies depending on whether or not the deviation (DV) when AT is begun is less than "the temporary AT execution judgement deviation" (initial setting 10.0% FS).

PV during AT is as follows:

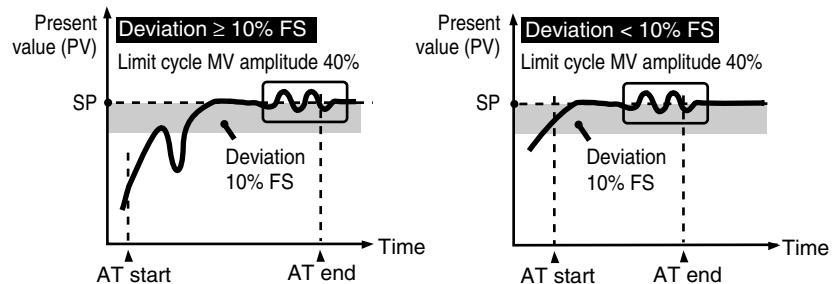

The amplitude of change of the limit cycle MV can be changed in "Limit cycle MV amplitude".

For heating/cooling and position proportional floating type control, the limit cycle is as follows regardless of the deviation.

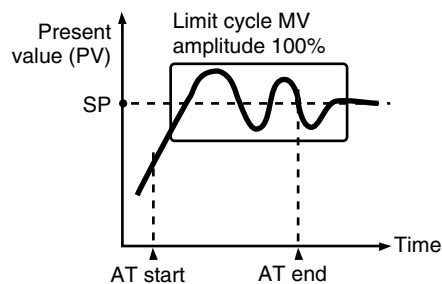

## Manual settings

To set the PID constants manually, set values for the "Proportional band (P)", "Integral time (I)", and "Derivative time (D)"

**Supplement**

- If you already know the control characteristics, directly set the PID constants and adjust control. The PID constants are set in "Proportional band (P)", "Integral time (I)", and "Derivative time (D)".
- I (Integral time) and D (Derivative time) can be set to "0" to select proportional action. In the initial settings, "the manual reset value" is set to 50.0% so that the proportional band is centered on the SP.

### When P (Proportional band) is changed

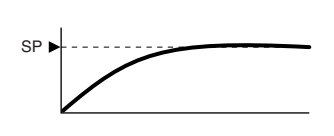
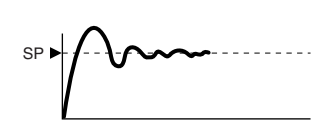
|                     |  |  |
|---------------------|--|--|
| When P is increased |  | Slow rise and a longer rectification time, but no overshoot.                   |
| When P is decreased |  | Overshoot and hunting occur, but attains the set value quickly and stabilizes. |

### When I (Integral time) is changed

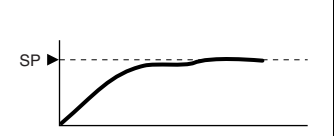
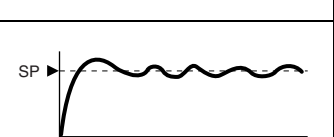
|                     |  |   |
|---------------------|--|---|
| When P is increased |  | Longer time to attain the SP. The rectification time is longer, but there is less hunting, overshoot, and undershoot. |
| When P is decreased |  | Overshoot and undershoot occur. Hunting occurs. Quick rise.   |

### When D (Derivative time) is changed

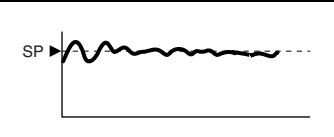
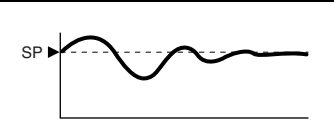
|                     |  |   |
|---------------------|--|---|
| When P is increased |  | Less overshoot and undershoot rectification time, but fine hunting occurs at own changes. |
| When P is decreased |  | Overshoot and undershoot increase and more time is needed to return to the SP.            |

## 4.11 Using auxiliary output

"Auxiliary output \* assignment", "Alarm type", "Alarm value", "Alarm upper limit", and "Alarm lower limit" are explained in this section.

### ■ Auxiliary output assignment

This setting assigns the type of data that is output from each auxiliary output.

On multi-point output types, data assignments can be set for channels 2 and higher as appropriate for the number of channels.

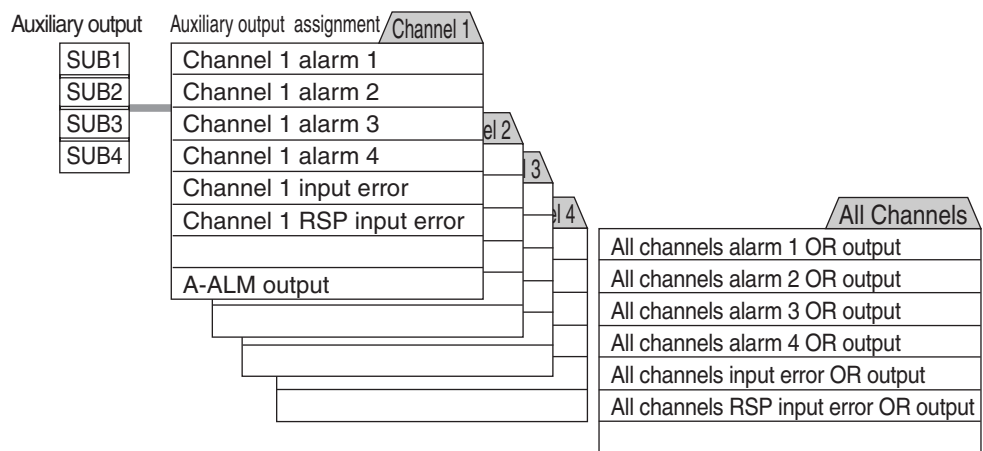

U-ALM output is an OR output (overall alarm) of alarms 1 to 4 of all channels.

The initial settings are as follows:

| Type   | SUB1        | SUB2        | SUB3        | SUB4        |
|--|-------------|-------------|-------------|-------------|
| 1-point input type                           | ch1 alarm 1 | ch1 alarm 2 | ch1 alarm 3 | ch1 alarm 4 |
| 2-point input type<br>E5AR-□□□W<br>E5ER-□□□W |             |             |             |             |
| 4-point input type<br>E5AR-□□WW              |             |             |             |             |

The E5ER-□2□□ and E5ER-□T□□ auxiliary output 2-point types are not equipped with SUB3 and SUB4.

## Alarm types

SP = Set point

| Set value (in general) | Alarm type  | Alarm output function       |                             |
|------------------------|---|-----------------------------|-----------------------------|
|                        |   | Alarm value (X) is positive | Alarm value (X) is negative |
| 0                      | Alarm function OFF  | Output OFF                  |                             |
| *1                     | 1 Upper-and lower-limit (deviation)                             |                             | *2                          |
|                        | 2 Upper-limit (deviation)                                       |                             |                             |
|                        | 3 Lower-limit (deviation)                                       |                             |                             |
| *1                     | 4 Upper-and lower-limit range (deviation)                       |                             | *3                          |
| *1,*6                  | 5 Upper-and lower-limit alarm with standby sequence (deviation) | *5                          | *4                          |
| *6                     | 6 Upper-limit alarm with standby sequence (deviation)           |                             |                             |
|                        | 7 Lower-limit alarm with standby sequence (deviation)           |                             |                             |
|                        | 8 Absolute-value upper-limit                                    |                             |                             |
|                        | 9 Absolute-value lower-limit                                    |                             |                             |
| *6                     | 10 Absolute-value upper-limit with standby sequence             |                             |                             |
| *6                     | 11 Absolute-value lower-limit with standby sequence             |                             |                             |

\*1: Set values (in general) 1, 4 and 5 allow upper and lower-limits of alarm value to be separately set, and are indicated by L and H.

\*2: Set value (in general) : 1 Upper-and lower-limit alarm

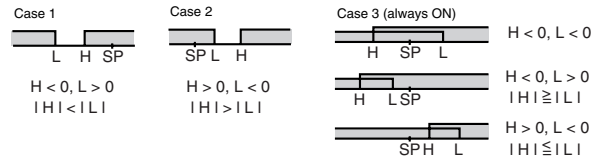

\*3: Set value (in general) : 4 Upper-and lower-limit range

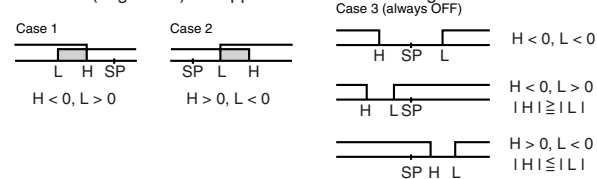

\*4: Set value (in general) : 5 Alarm with upper-and lower-limit standby sequence

\*With the above upper-and lower-limit alarms

•In cases 1 and 2

•In case 3, always OFF

If hysteresis overlaps at upper-and lower-limit, always OFF

\*5: Set value (in general) : 5 Alarm with upper-and lower-limit standby sequence

If hysteresis overlaps at upper-and lower-limit, always OFF

\*6: For information on standby sequences, see "5.6 Alarm adjustment functions".

- \* When using SP ramp, an alarm will activate during RUN with respect to the SP after ramping, and during STOP an alarm will activate with respect to the SP.

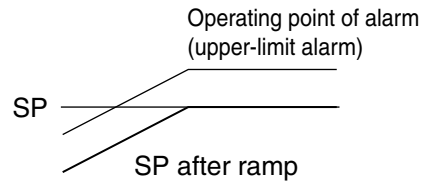

## ■ Alarm values

Alarm values are indicated by "X" in the alarm type table. When separate upper and lower limit alarm values are set, the upper limit value is indicated by "H" and the lower limit is indicated by "L".

When upper- and lower-limit, upper- and lower-limit range, or lower limit alarm with standby sequence is selected, the "Alarm upper limit" and "Alarm lower limit" settings must be configured.

"Alarm value" must be configured when any other alarm type is selected.

## ■ Settings

To output an alarm to the auxiliary output, the "Auxiliary output assignment", "Alarm type" and "Alarm value" settings must be configured.

Outputting a lower limit alarm to auxiliary output 2 using CH 1 alarm 1 and an alarm value of 10.0°C

### Auxiliary output 2 assignment

The following explains how to set "Auxiliary output 2 assignment" to "CH 1 alarm 1" in "Control initial setting level 2"

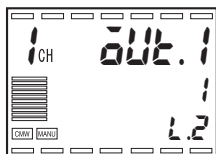
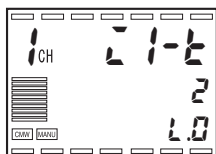
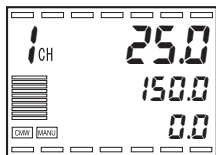

1. Hold down the  key at least 3 seconds to move from "RUN level" to "Input initial setting level".
2. In "Input initial setting level", Display 3 shows "L.0". Press the  key twice (less than 1 second each time) to move to "Control initial setting 2 level".
3. In "Control initial setting 2 level", Display 3 shows "L.2". Press the  key repeatedly (less than 1 second each time) to select "Auxiliary output 2 assignment".



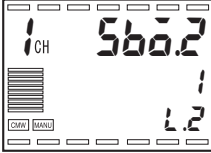
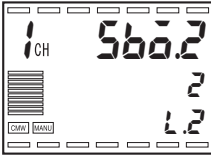

- Press the to set the auxiliary output 2 assignment to "1: CH 1 alarm 1".

**Alarm 1 type**

Set "Alarm 1 type" to "Lower-limit alarm" in "Alarm setting level".

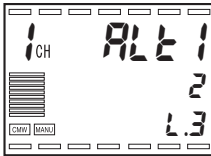

Alarm 1 type

- Press the key less than 1 second to move to "Alarm setting level". The display will show "Alarm 1 type".

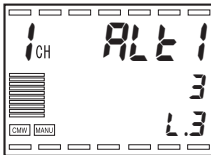

- Press the key to select "3: Lower limit alarm".

**Alarm value setting**

Set "Bank \* Alarm 1 value " to "10.0°C" in "Bank setting level"

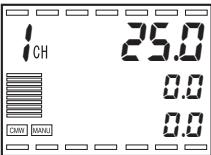

- Hold down the key at least 1 second to move to "RUN level".

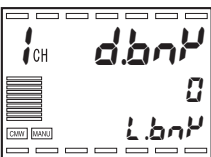

- Press the key three times (less than 1 second each time) to move to "Bank setting level".

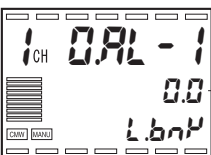

Bank 0 Alarm value 1

- Press the key repeatedly to select "Bank 0 alarm 1 value". Press the key to change the value to "10.0".

## 4.12 Starting and stopping control

### ■ Control run / Control stop

To start control, set "Run/Stop" to "Run". To stop control, set "Run/Stop" to "Stop".

#### ● MV at stop

- If you wish to output during stop in standard control, set an MV of -5.0 to 105.0% in "MV at stop". The initial setting is "0.0%". (In heating/cooling control, set to -105.0 to 105.0%)
- In position proportional control, "Open", "Closed", or "Hold" state can be selected in "MV at stop". In the "Open" state only the open output is ON, in the "Closed" state only the closed output is ON, and in the "Hold" state both open and closed outputs are OFF. The initial setting is "Hold".

#### ● Operation at power ON

- This selects the operation state when the power of the E5AR/ER is turned on. The following 3 selections are available.

| Setting values | Operation  |
|----------------|--|
| Continue       | Resumes the state of the system before the power was turned off. |
| Stop           | Control is stopped when the power is turned on.                  |
| Manual mode    | Enters manual mode when the power is turned on.                  |

- Setting values for operation at power ON and additional items are shown below.

| Operation after power ON | Additional items              |   |
|--------------------------|-------------------------------|---|
| Continue                 | Run/Stop<br>Auto/Manual<br>MV | Hold<br>Hold<br>From initial MV in auto mode<br>Hold in manual mode   |
| Stop                     | Run/Stop<br>Auto/Manual<br>MV | Stop<br>Hold<br>Hold if in manual mode before power off<br>MV at stop if in auto mode before power off  |
| Manual mode              | Run/Stop<br>Auto/Manual<br>MV | Hold<br>Manual<br>Manual MV default at time of power off if in manual mode before power off<br>MV at stop if in auto mode before power off (Note 1) |

- The initial setting is "Continue".
- Set "Operation at power off" separately for each channel.
- When the control mode is set to cascade control, set "Operation at power ON" for CH2.

Note 1: If the manual output mode is default value output, the default value of manual MV default is output.

## ■ Settings

The procedure for stopping control is as follows:

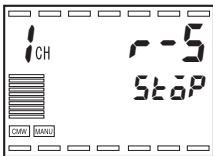
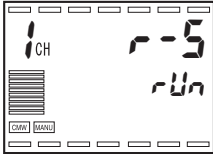
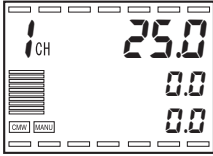

1. Press the  key repeatedly to select "r-5: Run/Stop".

2. Press the  key to switch to "STOP: Stop". The STOP indicator blinks and control stops.

To resume control, follow the same steps to switch to "run: Run". The STOP indicator goes off and control resumes.

**Hint**

Switching between run and stop is also possible by event input or communication.  
 For event input switching, see "5.7 Using event input" (P.5-29). For communication switching, see "5.9 Using communication functions" (P.5-34).

## 4.13 Performing manual control



### ■ Manual mode

- In standard control the MV is manipulated, and in position proportional control the amount of valve opening is manipulated.
- To perform manual operation or manually set the MV or valve opening, set the "Manual/Auto" setting to "MANU: Manual" or hold down the  key at least 1 second.

#### ● Standard type

- "MANU" lights up in the operation display while in manual mode. The PV appears in Display 1, the MV appears in Display 2, and "MANU" appears in Display 3.
- To change the MV, press the  keys. The MV is updated every 50 ms.
- When switching between manual mode and auto mode, the action of the MV is balance-less and bumpless.
- Other setting level can be moved to in manual mode. However, "AT Execute/Cancel" cannot be selected and does not appear in the display.
- Switching between auto and manual is possible a maximum of 100,000 times.
- During cascade control, if the primary loop is switched to manual control when the secondary loop is in any of the following conditions, the manual MV is disabled.
  - The SP mode of the secondary loop is local (cascade open).
  - The secondary loop is in manual mode.
  - "Operation at error" is taking place in the secondary loop.

#### ● Position proportional type

- When a potentiometer is connected, "MANU" lights up in the operation display while in manual mode. The PV appears in Display 1, the valve opening appears in Display 2, and "MANU" appears in Display 3. When a potentiometer is not connected, Display 2 shows "-----".
- To turn on open output, press the  key. To turn on closed output, press the  key. The MV is updated every 50 ms.
- When switching between manual mode and auto mode, the action of the MV is balance-less, bumpless.
- Other setting screens can be moved to in manual mode. However, "AT Execute/Cancel" cannot be selected and does not appear in the display.
- Switching between auto and manual is possible a maximum of 100,000 times.

The procedure for switching to manual mode during control and changing the MV is explained in the following.

◆ When Auto / Manual is selected with the PF1 setting or PF2 setting  
(Initially the PF1 setting is Auto / Manual.)

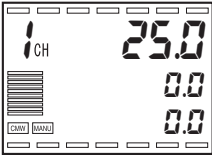

1. Hold down the **PF** key for Auto / Manual at least 1 second. The MANU indicator lights up and the mode changes to manual.

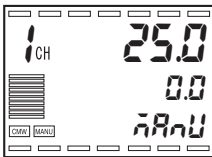

To return to auto mode, hold down the **PF** key at least 1 second. The MANU indicator goes off and the mode changes to auto.

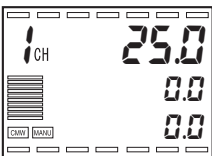

◆ When Auto / Manual is not selected with either the PF1 setting or PF2 setting

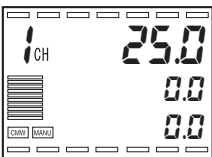

1. Press the **☐** key repeatedly to select "A-ā: Auto / Manual".

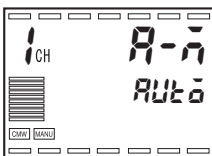

2. Press the **⊠** key to switch to "āRnU: Manual". The MANU indicator lights up and the mode changes to manual.

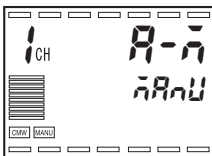

To resume control, follow the same procedure to switch back to "AUTO: Auto". The MANU indicator goes off and the mode changes to auto.

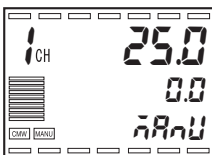

Hint

Switching between auto and manual is also possible by event input or communication. For event input switching, see "5.7 Using event input" (P.5-29). For communication switching, see "5.9 Using communication functions" (P.5-34).

## 4.14 Changing channels

### ■ Changing channels

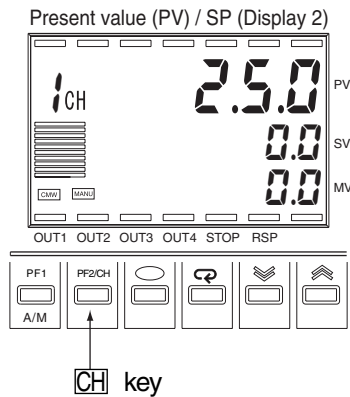

#### ● Level after changing channels

#### ● Displayed setting data after changing channels

- On multi-point input type, the channel number increases by 1 each time the **CH** key is pressed and the displayed channel changes accordingly.
- Only channels that are enabled with the "Number of enabled channels" setting can be displayed.
- If the "Number of enabled channels" setting is set to "2" on a 4-point input type, the display will switch through the channels as follows each time the **CH** key is pressed:  
Channel 1 → Channel 2 → Channel 1 → Channel 1...

- After changing channels, the level will be that of the currently displayed channel.
- When a manual mode channel is selected, the display will show the manual operation screen of "RUN level".
- Displayed data after changing channels is as follows:
  - ① If the setting data of a displayed channel continues to be effective after changing to a different channel, the setting data will be displayed.
  - ② If the setting data of a displayed channel will not be effective after changing to a different channel due to a different control method or other reason, the next effective setting data is displayed.

The following is an example of changing channels in "RUN level".

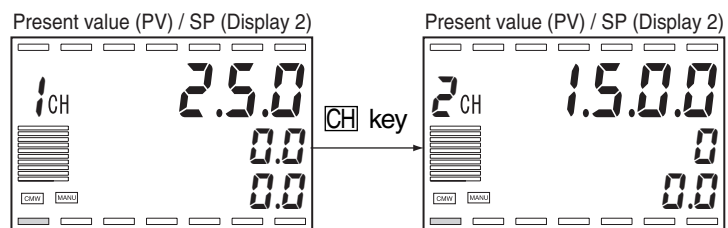

\* On models with only a single channel, the CH key is disabled.

\* Setting data for selected channel appears.

#### Hint

If you continue to hold down the **CH** key after changing channels, you will not move to the next channel. To continue changing channels, release and press the **CH** key again.  
For more information, see "5.4 Display and key adjustment functions" (P.5-19).

## 4.15 Operational considerations

---

- (1) About four seconds is required for the output to turn on after the power is turned on. Take this into consideration when incorporating the controller into a sequence circuit.
- (2) Using the controller near radios, televisions, or other wireless devices may cause reception interference.

# Section 5 *Functions and Operations*

|     |   |      |
|-----|---|------|
| 5.1 | Input adjustment functions.....           | 5-2  |
| 5.2 | Control functions.....                    | 5-8  |
| 5.3 | Output adjustment functions.....          | 5-16 |
| 5.4 | Display and key adjustment functions..... | 5-19 |
| 5.5 | Protecting settings .....                 | 5-24 |
| 5.6 | Alarm adjustment functions .....          | 5-26 |
| 5.7 | Using event input .....                   | 5-29 |
| 5.8 | Using transfer output .....               | 5-32 |
| 5.9 | Using communication functions .....       | 5-34 |



## 5.1 Input adjustment functions

### ■ Input shift

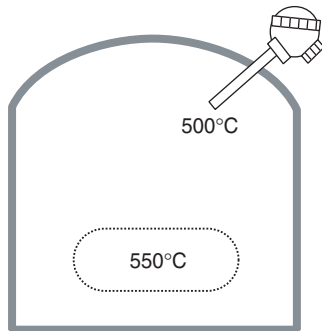

- Input shift is accomplished by 2-point correction.
- In the event that there is a large difference between the temperature at the sensor position and the temperature at a location where a temperature reading is required, with the result being that satisfactory control is not possible, the temperature difference can be set as an input shift value.

#### ● 2-point correction

|       |                           |
|-------|---------------------------|
| 252.1 | Input shift input value 1 |
| 252.2 | Input shift input value 2 |
| 255.1 | Input shift value 1       |
| 255.2 | Input shift value 2       |

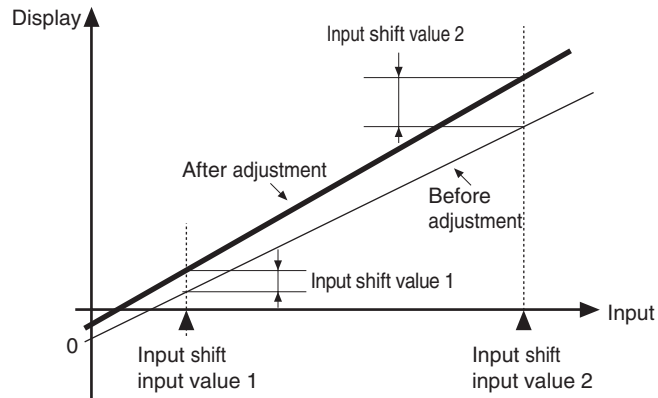

| Setting data                  | Setting range     | Units | Default value |
|-------------------------------|-------------------|-------|---------------|
| Input value for input shift 1 | -19999 to 99999   | EU    | -200.0        |
| Input value for input shift 2 | -19999 to 99999   | EU    | 1300.0        |
| Input shift 1                 | -199.99 to 999.99 | EU    | 0.00          |
| Input shift 2                 | -199.99 to 999.99 | EU    | 0.00          |

- Straight-line correction is accomplished by setting the value required to correct "Input value for input shift 1" in "Input shift 1", and the value required to correct "Input value for input shift 2" in "Input shift 2". Different correction values may be required for "Input shift 1" and "Input shift 2", and thus the slope of the line between the two points may differ before and after correction.
- Input shift is set for each channel. The input shift settings for inputs 1 to 4 of a multi-point input type correspond to channels 1 to 4. First select a channel with the **[CH]** key and then set the corresponding input shift values.

● **Obtaining input shift values (2-point correction)**

[Preparations]

Temperature readings are taken using the E5AR/ER at any two points and the actual temperature at the required location (the object) is measured at the same two points.

1. Set the input type based on the sensor.
2. Obtain a temperature sensor that can measure the temperature of the object similar to that shown in Figure 1.

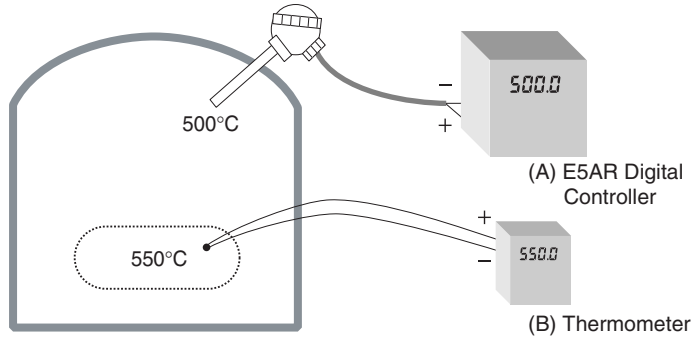

(Figure 1. Configuration for input shift)

● **Procedure for using 2-point correction**

1. Correction will be performed of the temperature readings at two points: one near room temperature and one near the desired SP. Measure the temperature of the object when it is near room temperature and when it is near the SP (B), and check the corresponding readings of the controller (A).
2. Set "Input shift 1" to the difference between the temperature of the object (B) and the controller reading (A) when near room temperature,

$$\text{Object temperature (B) - Controller reading (A)}$$

and set "Input value for input shift 1" to the controller reading (A).

3. Set "Input shift 2" to the difference between the temperature of the object (B) and the corresponding controller reading (A) when near the SP,

$$\text{Object temperature (B) - Controller reading (A)}$$

and set "Input value for input shift 2" to the controller reading (A).

4. After configuring the settings, check the reading of the controller (A) and the temperature of the object (B).
5. Correction has now been performed at two points, near room temperature and near the SP. If you wish to improve the accuracy near the SP, establish two more correction points above and below the SP. Figure 2 illustrates the correction.

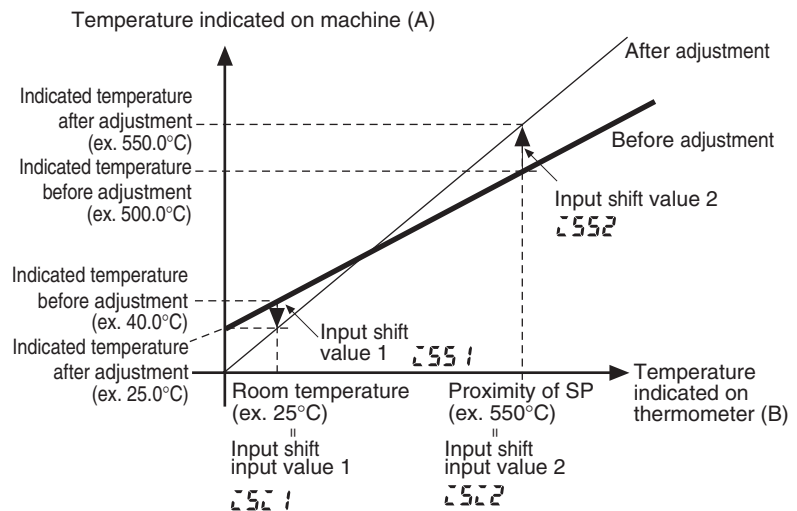

(Image adjustment by point adjustment of Fig. 2.2)



## ■ First order lag operation

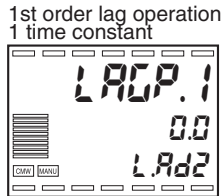
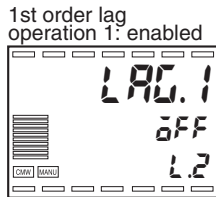

- First order lag operation serves as a filter for each input. For a multi-input type, the operation is set for each of inputs 1 to 4 in "First order lag operation 1 - 4".
- To use first order lag operation, set "First order lag operation enable" to "ON" (the initial setting is OFF). A time constant must also be set, and this is selected so that the result of the operation is 0.63 times the input data.

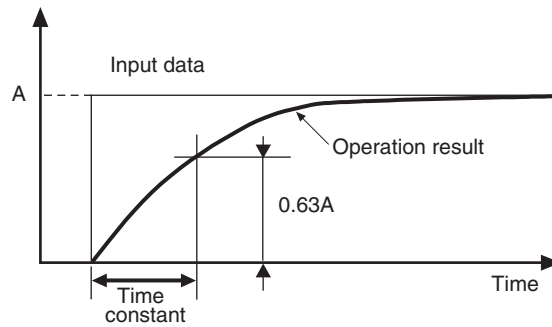

| Setting data                                    | Setting range              | Units | Default value |
|---|----------------------------|-------|---------------|
| First order lag operation 1 to 4: enable        | OFF: Disabled, ON: Enabled | -     | OFF           |
| First order lag operation 1 to 4 time constants | 0.0 to 999.9               | Sec   | 0.0           |

## ■ Move average

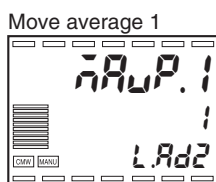
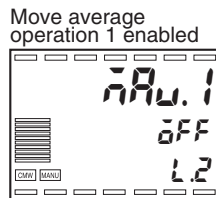

- The move average operation reduces sudden changes in the input due to noise and other factors, and can be enabled for each input.
- To use the move average operation, set "Move average enable" to "ON" (the initial setting is OFF).
- A count must also be selected in the "Move average" setting. Selections are 1, 2, 4, 8, 16, and 32 times.

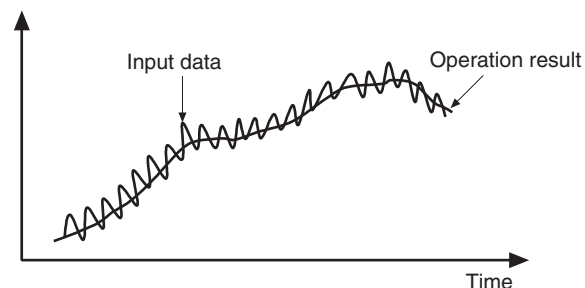

| Setting data                | Setting range              | Units         | Default value |
|-----------------------------|----------------------------|---------------|---------------|
| Move average 1 to 4: enable | OFF: Disabled, ON: Enabled | -             | OFF           |
| Move average 1 to 4         | 1, 2, 4, 8, 16, 32         | Times (count) | 1             |

## Broken-line approximation

This function is used to correct non-linearity in the input. Twenty broken-line approximation operation points are available for input 1.

To use broken-line approximation, set "Broken line approximation enable" to "ON" (the initial setting is OFF).

Broken-line approximation includes the settings "Broken-line approximation 1 Inputs 1 to 20" and "Broken-line approximation 1 Outputs 1 to 20". Normalized data is used to set the values such that the lower-limit of the input setting range for input 1 is 0.000 and the upper-limit is 1.000.

### Relation to input types

Broken-line approximation 1: enabled

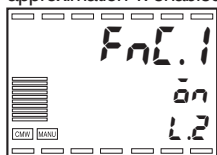

Broken-line approximation 1 Input 1

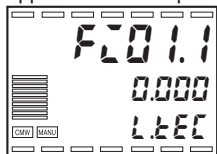

Broken-line approximation 1 Output 1

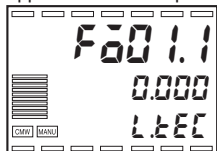

- Normalized data is used to set the values for broken-line approximation such that the lower-limit of the input setting range for input 1 is 0.000 and the upper-limit is 1.000. For example, if the input type of input 1 is J(2) -20.0 to 400.0°C and the broken-line approximation is to be applied to one point, 190.0°C, the values are set as follows:

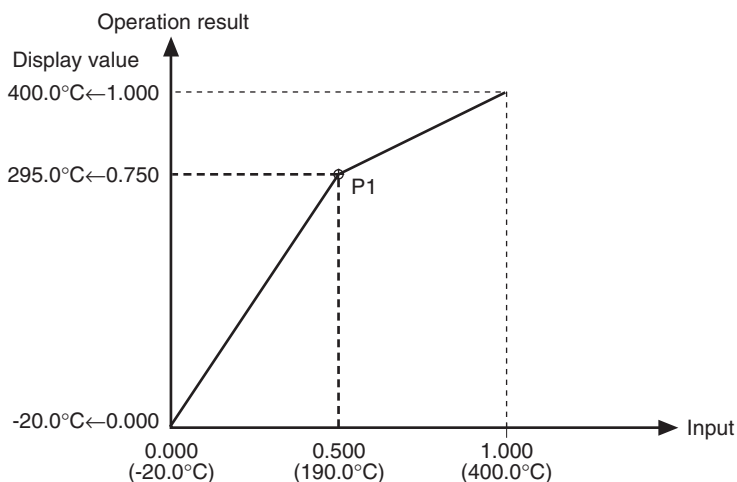

- Broken-line approximation 1 Input 1 = "0.000"
- Broken-line approximation 1 Output 1 = ""0.000"
- Broken-line approximation 1 Input 2 = "0.500"
- Broken-line approximation 1 Output 2 = "0.750"
- Broken-line approximation 1 Input 3 = "1.000"
- Broken-line approximation 1 Output 3 = "1.000"

| Setting data  | Setting range              | Units | Default value |
|---|----------------------------|-------|---------------|
| Broken-line approximation 1: enable   | OFF: Disabled, ON: Enabled | -     | OFF           |
| Broken-line approximation 1: Input 1 to Broken-line approximation 1: Input 20   | -1.999 to 9.999            | -     | 0.000         |
| Broken-line approximation 1: Output 1 to Broken-line approximation 1: Output 20 | -1.999 to 9.999            | -     | 0.000         |

## ■ Extraction of square root operations

Square root extraction operation 1 enabled

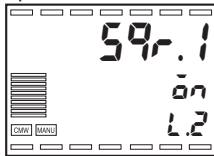

Square root extraction operation

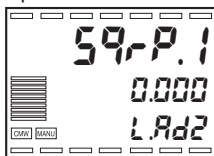

- A extraction of square root operations is available for each input to allow direct input of the signal from a pressure differential flow meter.
- To use square root extraction, set "Square root extraction enable" to "ON" (the initial setting is OFF).
- The square root extraction function includes the "Low-cut point" setting such that when the result of the operation is below the low-cut point, the result is set to "0". The low-cut point is set for each input using normalized data such that the lower-limit of the input setting range is 0.000 and the upper-limit is 1.000.

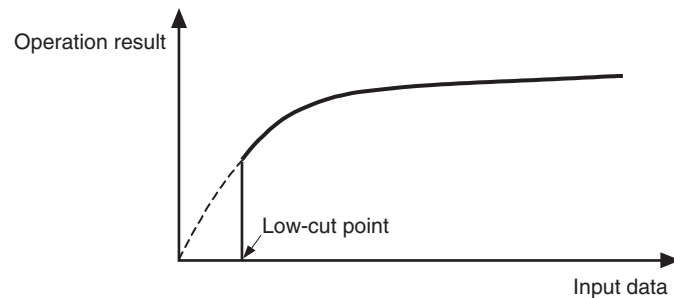

| Setting data                                | Setting range              | Units | Default value |
|---|----------------------------|-------|---------------|
| Square root extraction 1 to 4: enable       | OFF: Disabled, ON: Enabled | –     | OFF           |
| Square root extraction low-cut point 1 to 4 | 0.000 to 9.999             | EU    | 0.000         |

## ■ Other input adjustment functions

The following input adjustment functions are also available. These functions are explained in "Section 8 Setting data" (P. 8-1).

- Line noise reduction: Input initial setting level
- Display digits after PV decimal point: Input initial setting level

## 5.2 Control functions

### ■ SP ramp

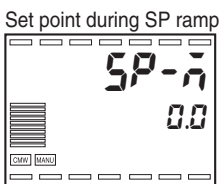
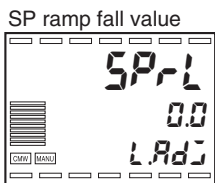
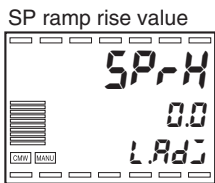
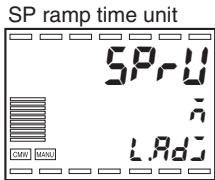

The SP ramp function limits the amount of change of the SP to a set rate. When this function is enabled and the amount of change exceeds the set rate, a space that limits the SP is created as shown in the diagram below

During SP ramp, control takes place not by changing the SP, but rather by using a value that is limited by the set rate of change (this is called the ramp SP).

On the E5AR/ER, an "SP ramp rise value" and an "SP ramp fall value" can be set separately.

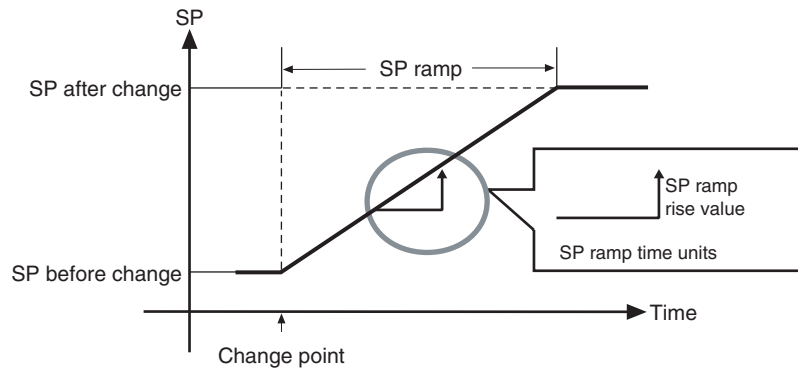

The rate of change during SP ramp is set in "SP ramp rise value", "SP ramp fall value", and "SP ramp time unit".

The initial settings for "SP ramp rise value" and "SP ramp fall value" are "0", which means that SP ramp is disabled.

"EU/sec", "EU/min" or "EU/hour" can be selected for "SP ramp time unit". The initial setting is "EU/min".

The ramp SP can be viewed using "Set point during SP ramp".

### ● Operation at startup (SP ramp)

When the power is turned on (including operation startup), the PV is regarded as the pre-change SP.

SP ramp operation at startup depends on the relation between the PV and SP as follows:

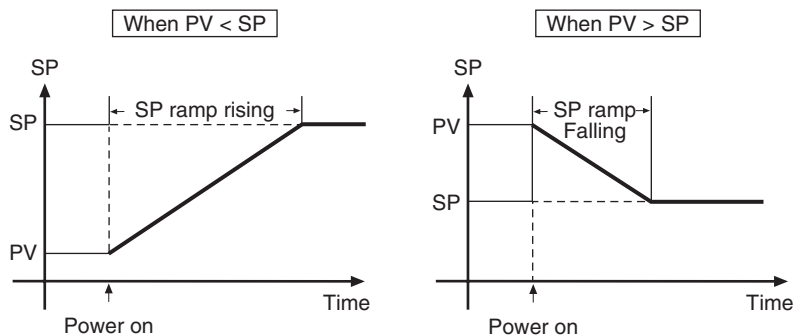

### ● Limitations during SP ramp

- AT starts at the SP during ramp.
- The ramp SP at AT startup is held during AT.
- SP ramp is disabled when operation is stopped.
- The SP ramp control begins with SP start after recovery from a sensor error. (Control begins about 1 second after recovery from a sensor error.)
- When a sensor error occurs, the goal SP takes effect and the alarm function operates with respect to the goal SP.

| Setting data             | Monitor and setting range              | Units | Default value |
|--------------------------|--|-------|---------------|
| SP ramp SP value monitor |  | EU    | -             |
| SP ramp rise value       | 0 to 99999 *2                          | *1    | 0             |
| SP ramp fall value       | 0 to 99999 *2                          | *1    | 0             |
| SP ramp time unit        | S: EU/sec,<br>M: EU/min,<br>H: EU/hour | -     | 1<br>(EU/min) |

\*1 EU/sec, EU/min, or EU/hour depending on the "SP ramp time unit" setting

\*2 The decimal point position depends on the input type.

### ■ Banks

- Up to eight banks can be created. Each bank is used to store an SP (local SP), alarm value, and a PID Set No..

| Bank No.                       | 0     | 1     | ... | 7 |
|--------------------------------|-------|-------|-----|---|
| Local SP                       | 200.0 | 500.0 |     |   |
| PID Set No.                    | 0     | 0     |     |   |
| Alarm value 1 to 4             | 240   | 300   |     |   |
| Alarm value upper limit 1 to 4 | 40    | 30    |     |   |
| Alarm value lower limit 1 to 4 | 40    | 30    |     |   |

### ● Local SP

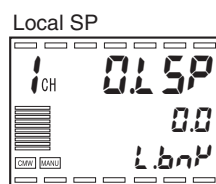

- The "Local SP" is the SP that is used during operation. The SP value that appears and can be set in the PV/SP setting screen in "RUN level" is the local SP value of the currently executing bank number.
- The bank number appears as the leading digit of the setting data.



● **PID Set No.**

PID\* Set No.

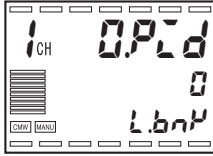

- To select and use a PID Set No., select 1 to 8 and then specify one of PID Set No. 1 to 8 for each bank.
- Normally the initial setting "0: Auto selection" is used. To use this setting data, see "■ PID sets" (P.5-12).
- To check the bank number, view the leading digit of the setting data.

● **Alarm values**

Alarm value 1

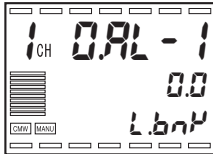

Alarm upper-limit value 1

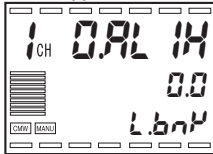

Alarm lower-limit value 1

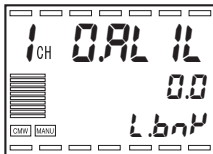

- Set alarm values for alarms 1 to 4 according to the alarm type. Alarms that have "Alarm type" set to "0: Alarm function OFF" are not displayed.
- See "4.11 Using auxiliary output" (P.4-23) for the setting procedure.
- To check the bank number, view the leading digit of the setting data.

Operation procedure

The procedures for setting the local SP and PID Set No. in Bank No. 2 and for running Bank No. 2 are explained in the following.

| Bank No.    | 0 | 1 | 2     | ... | 7 |
|-------------|---|---|-------|-----|---|
| Local SP    |   |   | 250.0 |     |   |
| PID Set No. |   |   | 3     |     |   |

RUN level

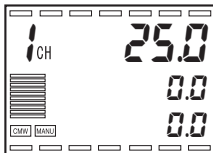

Bank display selection



**RUN level (PV/SP/MV)**

1. Press the  key repeatedly to move to "Bank setting level" (Display 3 shows *L.bank*).
2. Use the   keys to set "Display bank selection" to "2".



## ■ SP limits

SP setting upper limit

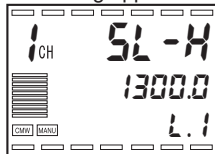

SP setting lower limit

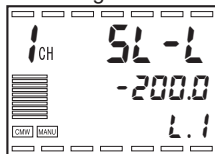

The SP setting upper and lower limits can be set within the input setting range.

If SP limits are set and the SP (local SP) falls outside the limits, the SP will be changed to either the upper or lower SP limit.

Example: Initially the SP is 200°C, the SP setting upper limit is 300°C, and the SP setting lower limit is 100°C. If the SP setting upper limit is changed to 150°C, the SP will fall outside of the SP limit range of 100 to 150°C, and thus will be changed to 150°C.

If "Input type", "Temperature units", or scaling is changed, the upper and lower SP limits will be reset to the upper and lower limits of the input setting range.

The SP limits are set separately for each channel.

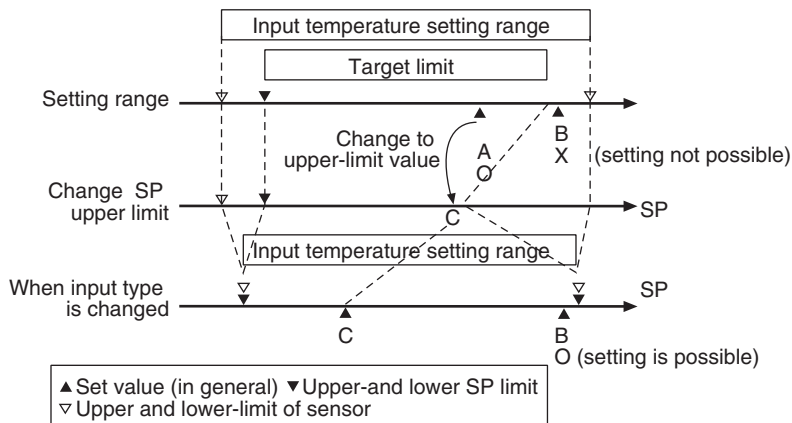

## ■ PID sets

- The E5AR/ER allows setting data to be grouped for use in PID control. A group of setting data is called a PID set. PID sets consist of the following setting data.

| PID Set No.                           | 1     | 2     | ... | 8 |
|---------------------------------------|-------|-------|-----|---|
| P (Proportional band)                 | 20.50 | 35.70 |     |   |
| I (Integral time)                     | 240   | 300   |     |   |
| D (Derivative time)                   | 40    | 30    |     |   |
| MV upper limit                        | 105.0 | 95.0  |     |   |
| MV lower limit                        | -5.0  | 5.0   |     |   |
| Automatic selection range upper limit | 200.0 | 400.0 |     |   |

- Select PID Set No. in "Display PID selection" of "PID setting level", and set the data for each PID.

## Operation procedure

Display PID\* selection

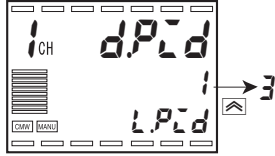

P (proportional band)

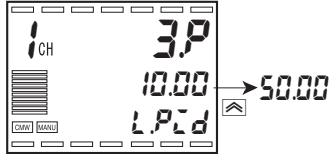

Set "P" (proportional band) of PID set 3 to 50.00 %FS.

1. Press the key repeatedly to move to "PID setting level" (Display 3 shows L.Pid).
2. Use the keys to set "Display PID selection" to "3".
3. Press the key to select "P (Proportional band)". To check the bank number, view the leading digit of the setting data.
4. Use the keys to set the value to "50.00".

- A PID Set No. (1 to 8) is set in "PID Set No." in "Bank setting level". For this reason, PID control parameters different from the selected bank can be used during operation.
- If "PID Set No." is set to "0", the PID set is automatically selected (PID auto selection) according to previously set conditions.

### ● PID set automatic selection

When "PID Set No." is set to "0" in a bank, the PID set is automatically selected according to previously set conditions.

| PID* set | Automatic selection range upper limit |
|----------|---------------------------------------|
| 1        | 200.0                                 |
| 2        | 400.0                                 |
| 3        | 500.0                                 |
| 4        | 600.0                                 |
| 5        | 700.0                                 |
| 6        | 800.0                                 |
| 7        | 1000.0                                |
| 8        | 1300.0                                |

PV (present value(PV)) 24.00

Internal fixed value: 999.9% FS

In the example at left ("PID set selection data" is set to "PV"),

When  $PV \leq 200.0^{\circ}\text{C}$ , PID Set 1 is used

When  $200.0 < PV \leq 400.0^{\circ}\text{C}$ , PID Set 2 is used

"PID automatic selection range upper limit" is set so that the value increases as the PID Set No. increases.

However, note that the value for PID Set 8 is internally fixed at "Automatic selection range upper limit" = 999.9% FS.

To prevent chattering when changing PID sets, hysteresis can be set in "PID set selection hysteresis".

PV or DV (deviation) can be selected for the "PID set selection data".

| Setting data  | Setting range                                | Units | Default value |
|---|--|-------|---------------|
| Banks 0 to 7 PID Set No.                              | 0: Auto selection<br>1 to 8: PID Sets 1 to 8 | –     | 0             |
| PID Sets 1 to 8 Automatic selection range upper limit | -19999 to 99999                              | EU    | 1450.0        |
| PID set selection data                                | 0: PV, 1: DV                                 | –     | 0: PV         |
| PID set selection hysteresis                          | 0.10 to 99.99                                | %FS   | 0.50          |

## ■ Disturbance overshoot adjustment

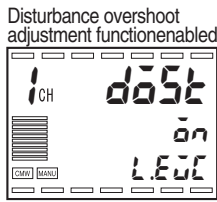

- The disturbance overshoot adjustment function adjusts the control waveform when a disturbance occurs.
- To use this function, set "Disturbance overshoot adjustment function" to "ON" (the initial setting is "OFF").
- The disturbance response waveform can be adjusted using the "Disturbance gain" and "Constant at disturbance" settings.

### ● Disturbance gain

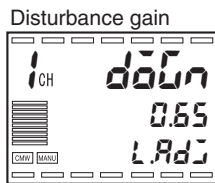

- The "Disturbance gain" setting can be increased to reduce overshoot when a disturbance occurs.
- The "Disturbance gain" setting can be decreased to increase overshoot when a disturbance occurs.
- When "Disturbance gain" is set to "0", the disturbance overshoot adjustment function does not operate.

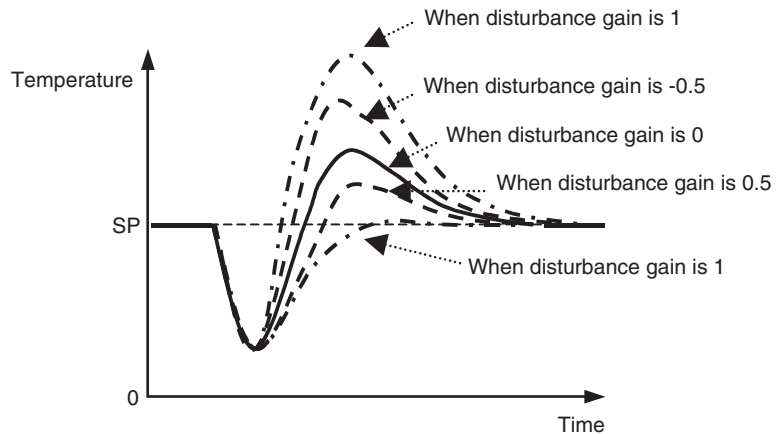

### ● Constant at disturbance

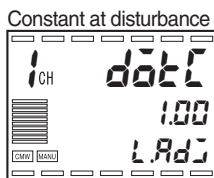

- The reset time after a disturbance can be lengthened by increasing the disturbance time constant. (The default value "1" is normally used for the disturbance time constant. In the event that adjustment of the disturbance gain alone is not sufficient, this value can be adjusted for fine-tuning.)

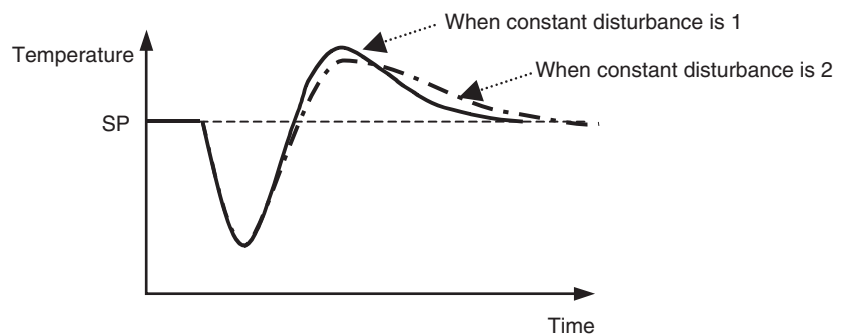

- The waveform may vary from that in the diagram depending on differences in the object of control and differences in PID values.

## ● Conditions for activation of disturbance overshoot adjustment

Disturbance rectification band

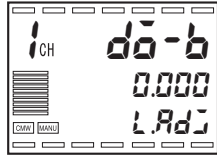

- If the deviation is greater than the "Disturbance judgement width" after the PV is rectified to the "Disturbance rectification band", the disturbance overshoot adjustment function activates.
- When the "Disturbance judgement width" is a positive value, disturbance overshoot adjustment will activate when a disturbance occurs that makes the PV fall. When the "Disturbance judgement width" is a negative value, disturbance overshoot adjustment will activate when a disturbance occurs that makes the PV rise.
- Disturbance overshoot adjustment does not activate in the following situations:
  - When "Disturbance rectification band" or "Disturbance judgement width" is set to "0".
  - When the SP is changed (when the SP change width exceeds the "Disturbance rectification band")
  - During AT
  - During ON/OFF control (P = 0.00)
  - During PD control (I = 0.00)

Disturbance judgement width

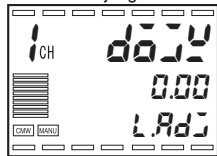

- The units for the "Disturbance rectification band" and "Disturbance judgement width" settings are % FS. As such, if the input type is K(1) -200.0 to 1300.0°C and you wish to set the "Disturbance judgement width" to 15.0°C,  $15.0^{\circ}\text{C}/1500.0^{\circ}\text{C} \times 100 = 1.00\% \text{FS}$  hence "1.00" should be set.

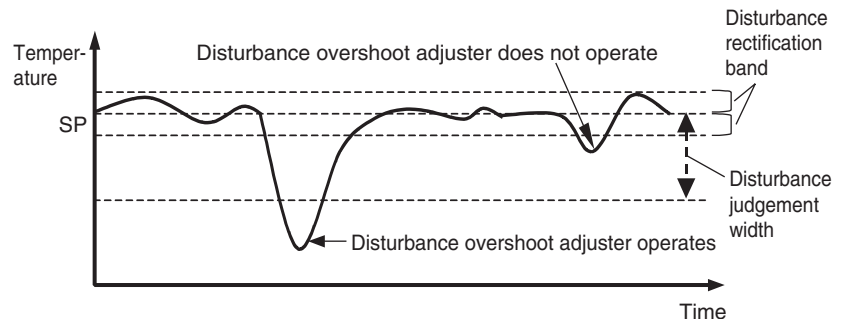

| Setting data                            | Setting range              | Units | Default value |
|---|----------------------------|-------|---------------|
| Disturbance overshoot adjustment enable | OFF: Disabled, ON: Enabled | –     | OFF           |
| Disturbance gain                        | -1.00 to 1.00              | –     | 0.65          |
| Disturbance time constant               | 0.01 to 99.99              | –     | 1.00          |
| Disturbance rectification band          | 0.000 to 9.999             | %FS   | 0.000         |
| Disturbance judgement width             | -99.99 to 99.99            | %FS   | 0.00          |

## 5.3 Output adjustment functions

### ■ MV limit

- Upper and lower limits can be applied to the output of the calculated MV.
- When using ON/OFF control, the MV will be the MV upper limit when output is ON and the MV lower limit when output is OFF.
- The MV limit function does not operate when floating control is selected on a position proportional type.
- The following MVs take precedence over the MV limit function.  
Manual MV default  
MV at stop  
MV at PV error

Upper limit value of MV limit

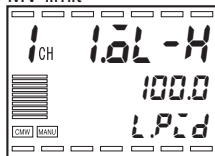

Lower limit value of MV limit

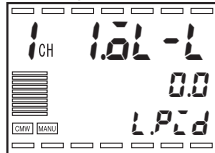

- The "MV upper limit" and "MV lower limit" can also be set in each PID set.

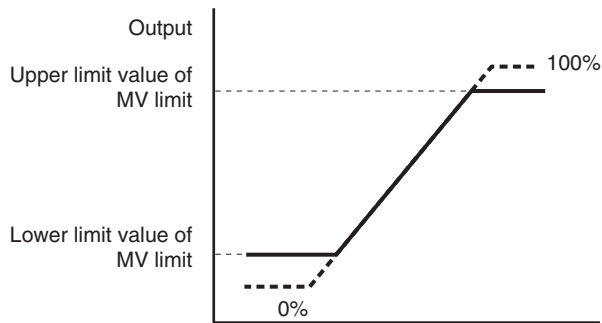

- In the case of heating/cooling control, overall upper and lower limits are set for heating and cooling. (Separate limit settings are not possible.)

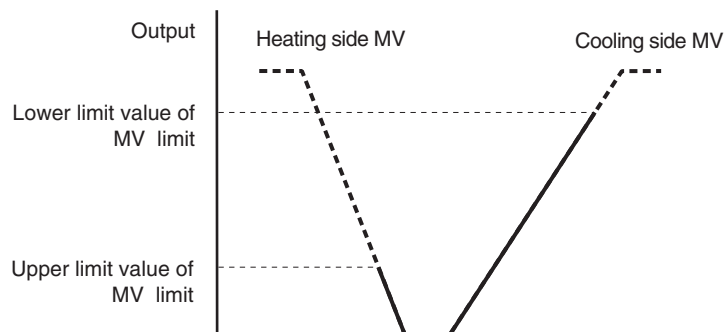

| Setting data   | Setting range                                      | Units | Default value |
|----------------|--|-------|---------------|
| MV upper limit | Standard control:<br>MV lower limit + 0.1 to 105.0 | %     | 100.0         |
|                | Heating/cooling control:<br>0.0 to 105.0           | %     | 100.0         |
| MV lower limit | Standard control:<br>-5.0 to MV upper limit - 0.1  | %     | 0.0           |
|                | Heating/cooling control:<br>-105.0 to 0.0          | %     | -100.0        |

## ■ MV change rate limit

MV change rate limit (heating)

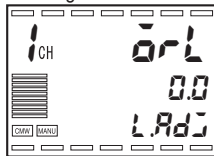

MV change rate limit (cooling)

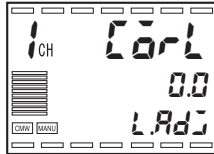

MV change rate limit mode

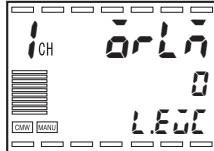

- The MV change rate limit is used to set a maximum allowed change per second in the MV (or in the opening of a valve in the case of a position proportional control type). If a change occurs in the MV that exceeds this setting, the MV is changed by the set limit each second until the required change is attained. When the limit is set to "0", the function is disabled.
- For standard control, use "MV change rate limit (heat)". "MV change rate limit (cool)" cannot be used.
- For heating/cooling control, separate limits can be set for heating and cooling. "MV change rate limit (heat)" is used for heating and "MV change rate limit (cool)" is used for cooling.
- The MV change rate limit cannot be used in the following conditions:
  - Manual mode
  - During AT
  - During ON/OFF control (P=0.00)
  - When control is stopped (MV output at Stop)
  - During MV output at PV error
- If you only wish to limit the rate of increase in the MV, set the "MV change rate limit mode" to "1".

| Setting data                | Setting range                            | Units | Default value |
|-----------------------------|--|-------|---------------|
| MV change rate limit (heat) | 0.0 to 100.0                             | %/sec | 0.0           |
| MV change rate limit (cool) | 0.0 to 100.0                             | %/sec | 0.0           |
| MV change rate limit mode   | 0: Increase/Decrease<br>1: Increase only | -     | 0             |



## ■ MV at Stop

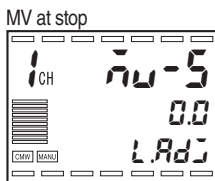

- This specifies the MV when control is stopped.  
In heating/cooling control a negative value is used for the cooling MV, thus when "MV at Stop" is positive, the MV will be sent to the heating output, and when negative the MV will be sent to the cooling output.  
The initial setting is "0.0", which means there is no output at stop for either standard or heating/cooling control.

| Setting data | Setting range   | Units | Default value |
|--------------|---|-------|---------------|
| MV at Stop   | -5.0 to 105.0<br>(Standard control)<br><br>-105.0 to 105.0<br>(Heating/cooling control) | %     | 0.0           |

Note: The order of priority of the MV settings is  
Manual MV default > at Stop > MV at PV error

## ■ MV at PV error

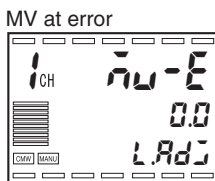

This setting is used to output a fixed MV when an input error PV error or remote SP input error occurs.  
When position proportional control is selected, "MV at PV error" also functions when a potentiometer input error occurs (when "Operation at potentiometer input error" = "Stop" or "Closed").  
When control is stopped, "at Stop" takes precedence. In manual mode, the manual MV default takes precedence.

| Setting data                                   | Setting range   | Units | Default value |
|--|---|-------|---------------|
| MV at PV error<br>(Standard type)              | -5.0 to 105.0<br>(Standard control)<br><br>-105.0 to 105.0<br>(Heating/cooling control)   | %     | 0.0           |
| MV at PV error<br>(Position proportional type) | -1 : Closed output ON<br>(Valve completely open)<br>0 : No output (valve opening hold)<br>1 : Open output ON<br>(Valve completely closed) | -     | 0             |

Note: The order of priority of the MV settings is  
Manual MV default > at Stop > MV at PV error

## 5.4 Display and key adjustment functions

### ■ Display scan

Display scan is used to automatically change display channels on a multi-point input type.

This function only applies to channels that are enabled in the "Number of enabled channels" setting.

If the "Number of enabled channels" is "3", channels 1, 2, and 3 are displayed.

#### ● Display scan start/stop

Display scan can be started automatically after power-on or by pressing the **CH** key.

To stop display scan, hold down the **CH** key for at least 1 second.

Use the "Begin display scan after power on" and "Display scan period" settings to specify how display scan operates.

| Setting values                    |                     | Start display scan after power on | Display scan using <b>CH</b> key |
|-----------------------------------|---------------------|-----------------------------------|----------------------------------|
| Begin display scan after power on | Display scan period |                                   |                                  |
| OFF                               | 0 (=OFF)            | Disabled                          | Disabled                         |
|                                   | 1 to 99             |                                   | Enabled                          |
| ON                                | 0 (=OFF)            | Disabled                          | Disabled                         |
|                                   | 1 to 99             | Enabled                           | Enabled                          |

Begin display scan after power on

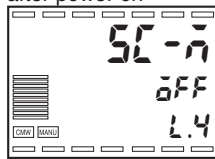

Display scan period

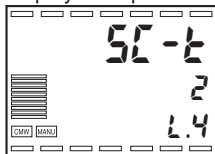

- When display scan is enabled, use the **CH** key to start or stop display scan.
- To start display scan, hold down the **CH** key in the Operation, Adjustment, Adjustment 2, Bank setting, PID setting, Approximation setting, or Monitor item level. Display 1 starts to blink after the key is held down for 1 second, and after the key is held down for another 2 seconds, the display stops blinking and display scan begins.
- If the **CH** key is held down for more than 1 second during display scan, display scan will stop.
- During display scan, only the **CH** key is enabled. To use any other keys, display scan must first be stopped with the **CH** key.
- Channel display in manual mode shows the manual operation screen.

◆ Example of display scan operation

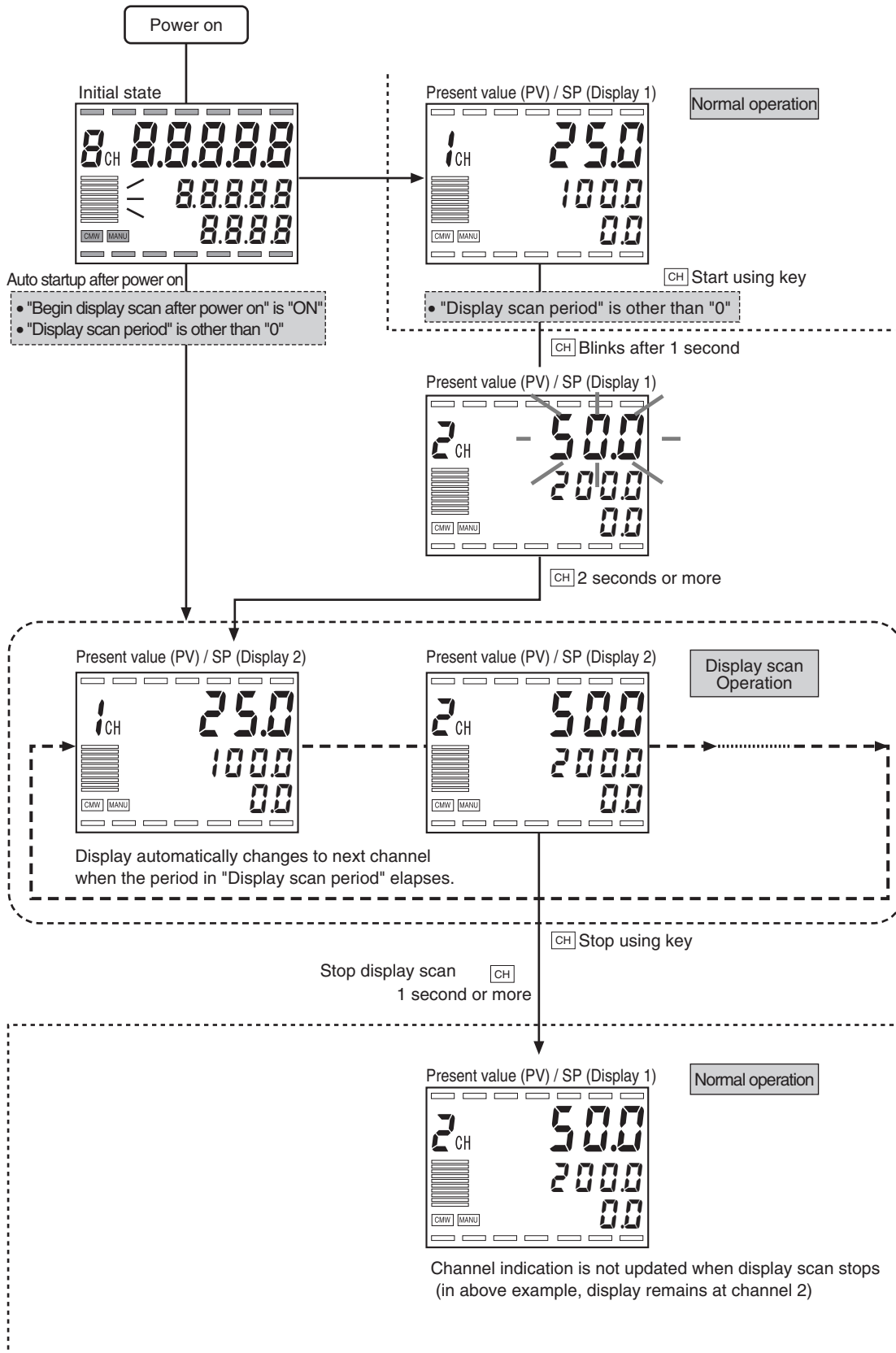

## ■ PF settings (function keys)

PF1 setting

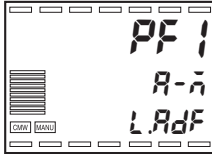

PF2 setting

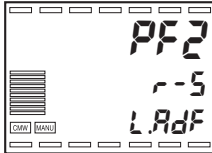

- The **PF1** and **PF2** serve as function keys, and the functions of these keys can be selected.
- Note that on a multi-point input type, the **PF2** key functions as a **CH** key, and thus it cannot be used as a function key (the "PF2 setting" does not appear). However, the key can be used as a function key if the number of enabled channels is set to "1".

| Setting values     | Description          | Function   |
|--------------------|----------------------|--|
| OFF: $\bar{a}FF$   | Disabled             | Does not function as a function key.   |
| RUN: $rUn$         | Run                  | Run currently displayed channel.   |
| STOP: $St\bar{a}P$ | Stop                 | Stop currently displayed channel.  |
| R-S: $r-s$         | Run/Stop             | Switch between run and stop for currently displayed channel.   |
| ALLR: $ALLr$       | Run all              | Run all channels.  |
| ALLS: $ALLS$       | Stop all             | Stop all channels.   |
| AT: $At$           | AT Execute / Cancel  | Switch between AT execute and AT cancel.<br>AT run is executed for the currently selected PID set.                         |
| BANK: $bAnM$       | Bank selection       | Switch through the bank numbers (adds 1 to the current bank number).   |
| A-M: $A-M$         | <b>A/M</b> key       | Switch between auto and manual.  |
| PFDP: $PFdP$       | Monitor/Setting item | Display monitor/setting item.<br>Select "Monitor / Setting item 1" to "Monitor / Setting item 5" (Special function level). |

- Hold down the PF1 or PF2 for at least 1 second to execute the function selected in "PF1 setting" or "PF2 setting".

If "Monitor / Setting item" is selected, the display will scroll through monitor/setting items 1 to 5 each time you press the key.

\* The initial settings for the function keys are as follows:

PF1 setting: "A-M" (**A/M** key)

PF2 setting: "R-S" (run/stop toggle)

\* The function keys are only effective in the Operation, Adjustment, Adjustment 2, Bank setting, PID setting, Approximation setting, Monitor item level, and Protect levels.

The keys are only effective when "PF key protect" is "OFF".

\* "Operation adjustment protect" and "Setting change protect" do not apply to the function keys.

"Run/Stop" and "Bank No." parameter settings can be changed and saved using a function key if the key is set to the corresponding function.

- **Monitor/Setting item** "PF1 setting" or "PF2 setting" can be set to "Monitor/Settings (PF dP)" to display monitor/settings using a function key.

The content to be displayed is set for each channel in "Monitor / Setting item 1" through "Monitor / Setting item 5" of the corresponding function key.

The selections are shown in the following table (for the setting (or monitor) ranges, see the respective explanations of the setting data).

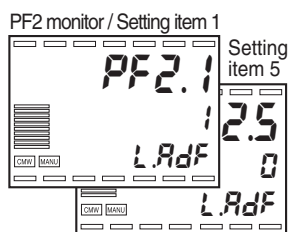
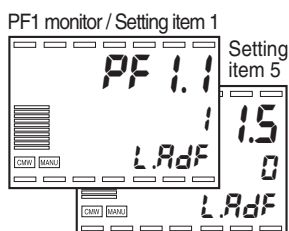

| Setting value | Description           | Remarks         |         |
|---------------|-----------------------|-----------------|---------|
|               |                       | Monitor/Setting | Display |
| 0             | Disabled              |                 |         |
| 1             | PV/SP/Bank No.        | Can set (SP)    | —       |
| 2             | PV/SP/MV              | Can set (SP)    | —       |
| 3             | PV/Deviation          | Monitor only    | —       |
| 4             | Proportional band (P) | Can set         | P       |
| 5             | Integral time (I)     | Can set         | i       |
| 6             | Derivative time (D)   | Can set         | d       |
| 7             | Alarm 1               | Can set         | AL - 1  |
| 8             | Alarm upper limit 1   | Can set         | AL 1H   |
| 9             | Alarm lower limit 1   | Can set         | AL 1L   |
| 10            | Alarm 2               | Can set         | AL - 2  |
| 11            | Alarm upper limit 2   | Can set         | AL 2H   |
| 12            | Alarm lower limit 2   | Can set         | AL 2L   |
| 13            | Alarm 3               | Can set         | AL - 3  |
| 14            | Alarm upper limit 3   | Can set         | AL 3H   |
| 15            | Alarm lower limit 3   | Can set         | AL 3L   |
| 16            | Alarm 4               | Can set         | AL - 4  |
| 17            | Alarm upper limit 4   | Can set         | AL 4H   |
| 18            | Alarm lower limit 4   | Can set         | AL 4L   |
| 19            | Bank No.              | Can set         | BRN     |

#### ◆ Displaying "Monitor/Setting item"

To display "Monitor/Setting item", press the function key in Operation, Adjustment, Adjustment 2, Bank setting, PID setting, Approximation setting or Monitor item level.

Press the key repeatedly to scroll from "Monitor/Setting item 1" to "Monitor/Setting item 5". After "Monitor/Setting item 5", the display changes to the first parameter in RUN level.

\* If any of settings "Monitor/Setting item 1" through "Monitor/Setting item 5" are disabled, those settings will not appear and the display will show the next enabled setting.

- \* If another key is pressed during display of "Monitor/Setting item", the following will take place:
  - If the mode or level key is pressed, the first parameter in RUN level will appear.
  - If a function key set as a channel key is pressed, the channel will change and the first parameter in RUN level of the new channel will appear.
  - If the other function key is pressed and it is also set to "Monitor/Setting item", the "Monitor/Setting item" of that key will appear.
  - If the other function key is pressed and it is set to a function other than the above (such as the  $\overline{A/M}$  key), that function will activate.
  
- \* Display 3 operates as follows during Monitor/Setting item
  - If PV/SP/Bank No. is displayed, Display 3 shows the bank number.
  - If PV/SP/MV is displayed, Display 3 becomes a monitor that shows the MV.
  - In cases other than the above, the display goes off.

## ■ Other display and key adjustment functions

Other display and key adjustment functions are available. These functions are explained in "Section 8 Setting data".

- "PV/SP" display screen selection : Display adjustment level
- Bar graph display item (E5AR only) : Display adjustment level
- Display auto reset : Display adjustment level
- Display refresh period : Display adjustment level
- Monitor item level setting : Display adjustment level
- Display digits after PV decimal point : Initial setting level

## 5.5 Protecting settings

### ■ Protect

The protect function is used to restrict access to settings in order to prevent accidental changes to the settings.

Protect functions include "Operation adjustment protect", "Initial setting protect", "Setting change protect", and "PF key protect".

#### ● Operation adjustment protect

RUN adjustment protect

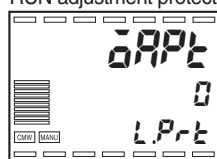

This function restricts key operation in Operation, Adjustment, Adjustment 2, Bank setting, PID setting, Approximation setting and Monitor item levels.

| Setting value | Operation |       | Adjustment/ Adjustment 2 | Bank setting<br>PID setting<br>Approximation setting<br>Monitor item |
|---------------|-----------|-------|--------------------------|--|
|               | "PV/SP"   | Other |                          |  |
| 0             | ⊙         | ⊙     | ⊙                        | ⊙  |
| 1             | ⊙         | ⊙     | ⊙                        | ×  |
| 2             | ⊙         | ⊙     | ×                        | ×  |
| 3             | ⊙         | ×     | ×                        | ×  |
| 4             | ○         | ×     | ×                        | ×  |

- ⊙: Can display and change
- ○: Can display
- ×: Cannot display or move to level
- The default value is "0".

#### ● Initial setting protect

Initial setting protect

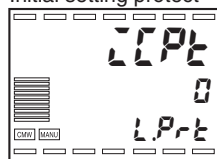

This setting restricts access to Input initial setting, Control initial setting, Control initial setting 2, Alarm setting, Display adjustment, and Communications setting levels.



| Setting value | Move to input initial setting level                                 | Move to Control initial setting / Control initial setting 2 / Alarm setting / Display adjustment / Communications setting level |
|---------------|---|---|
| 0             | Allowed (Displays "Move to special function setting level")         | Allowed   |
| 1             | Allowed (Does not display "Move to special function setting level") | Allowed   |
| 2             | Prohibited  | Prohibited  |

- When "Initial setting level protect" is set to "2", nothing happens when the level key is held down to move to Input initial setting level from Operation, Adjustment, Adjustment 2, Bank setting, PID setting, Approximation setting or Monitor item level (the blinking display to indicate movement to another level also does not appear).
- "Initial setting level protect" is initially set to "0".

## ● Setting change protect

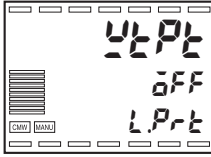
Setting change protect



This function prevents use of the   keys.

| Setting value | Description  |
|---------------|--|
| OFF           | Keys can be used to change settings.   |
| ON            | Keys cannot be used to change settings. (However, settings can be changed in Protect level.) |

- The initial setting is OFF.

## ● PF key protect

PF key protect

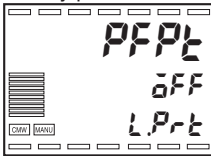

This function prevents use of the PF1/PF2 keys.

| Setting value | Description  |
|---------------|--|
| OFF           | PF1/PF2 keys are enabled.  |
| ON            | PF1/PF2 keys are disabled. (Prohibits use as a function key or a channel key.) |

- The initial setting for "PF key protect" is "OFF".



## 5.6 Alarm adjustment functions

### ■ Alarm hysteresis

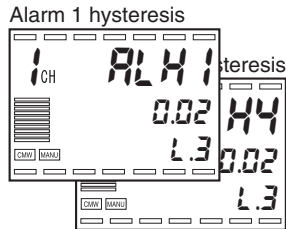

- Hysteresis can be applied when alarm outputs switch on and off, as shown below.

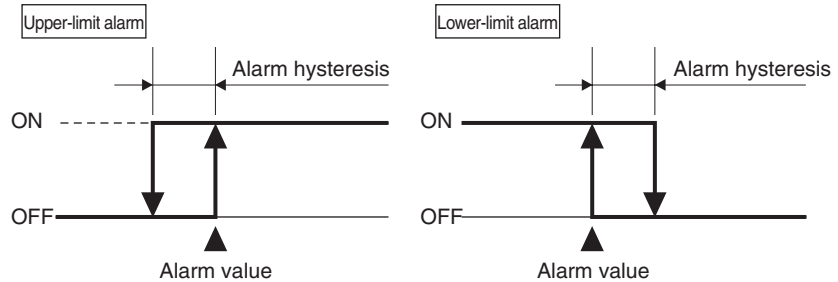

- Alarm hysteresis can be set separately for each alarm in "Alarm 1 to 4 hysteresis".
- All default values are "0.02" (%FS).

### ■ Standby sequence

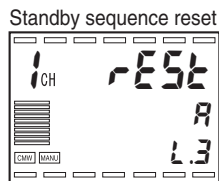

- "Standby sequence" is used to delay alarm output until the PV leaves the alarm range once and then subsequently enters it again.
- For example, in the case of a lower-limit, the PV is normally smaller than the SP when the power is turned on and thus is within the alarm range, which would cause the alarm output to switch on. However, if "With lower limit standby sequence" is selected, the alarm output will not switch on until the PV rises above the alarm set value and out of the alarm range, and then falls below the alarm value a second time.

#### ● Standby sequence restart

- The standby sequence is canceled when alarm output occurs, and then restarts based on conditions specified in the "Standby sequence reset" setting.
- Condition A:  
Operation startup (including power on), or when the alarm value (alarm upper- and lower-limit) or input shift (input value for input shift 1, input shift 1, input value for input shift 2, or input shift 2) is changed, or when the SP is changed.
- Condition B:  
At power on
- The "Standby sequence reset" setting is common to Alarms 1 to 4.
- The initial setting is "0: Condition A".

### Alarm latch

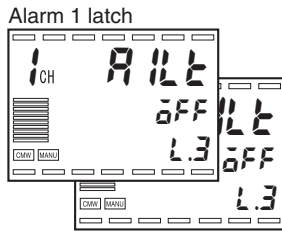

- The Alarm latch function is used to make an alarm output that has switched on remain on until the power is turned off, regardless of the temperature.
- The alarm latch state can be canceled by turning the power off or by a communication command.
- Alarm latch is set separately for each alarm in "Alarm 1-4 latch".
- The initial setting is "0: OFF".

### Close in alarm/Open in alarm

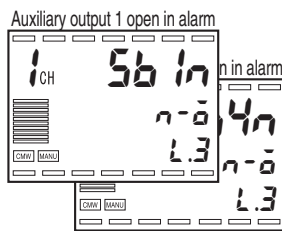

- When close in alarm is selected, an alarm output state is output as-is. When open in alarm is selected, the alarm output state is inverted before output.
- Close in alarm/Open in alarm is set separately for each auxiliary output in "Auxiliary output 1-4 non-exiting".
- The initial setting is "n-0: Close in alarm".

| Setting data        | Auxiliary output function | Auxiliary output | Operation indicator |
|---------------------|---------------------------|------------------|---------------------|
| Close in alarm: n-0 | ON                        | ON               | On                  |
|                     | OFF                       | OFF              | Off                 |
| Open in alarm: n-1  | ON                        | OFF              | On                  |
|                     | OFF                       | ON               | Off                 |

- When the power is turned off and for about 2 seconds after the power is turned on, the auxiliary outputs are OFF (open).

### Alarm operation summary

- The following example summarizes alarm operation ("Lower limit alarm standby sequence" and "Close in alarm" are selected).

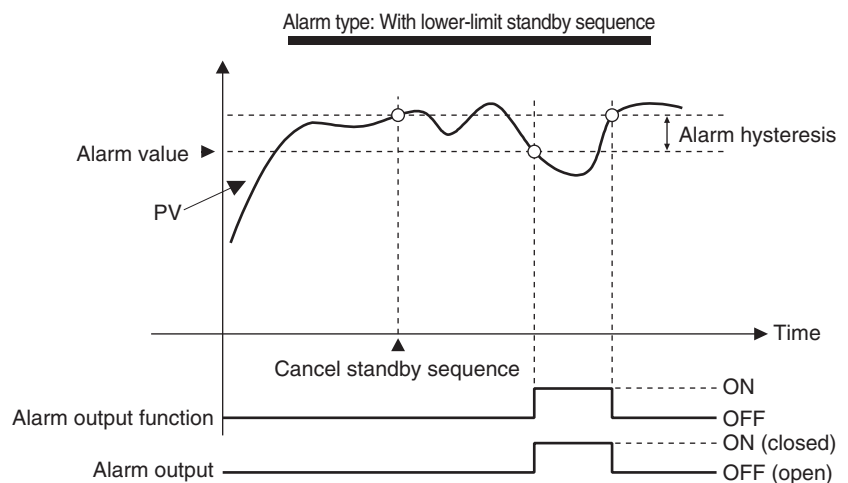

| Display characters | Setting data name                      | Level (Display 3)  | Use                                      |
|--------------------|--|--------------------|--|
| <i>ALt</i> *       | Alarms 1 to 4 Type                     | Alarm setting (L3) | Sets the alarm type                      |
| <i>A * Lt</i>      | Alarms 1 to 4 Latch                    | Alarm setting (L3) | Alarm output latch (hold)                |
| <i>ALH</i> *       | Alarms 1 to 4 Hysteresis               | Alarm setting (L3) | Alarm output hysteresis                  |
| <i>rESt</i>        | Standby sequence reset                 | Alarm setting (L3) | Sets standby sequence restart conditions |
| <i>Sb * n</i>      | Auxiliary outputs 1 to 4 Open in alarm | Alarm setting (L3) | Close in alarm/Open in alarm             |

\*:1 to 4

## 5.7 Using event input

- Event input can be used on the E5AR-□□B (2-input), E5ER-□□B(2-point), E5AR-□□D (4-point), E5ER-□□D (4-point), and E5AR-□□DB (6-point).
- An order of priority exists for event input, key operation, and communication settings, with the most recent setting taking precedence.
- Operation changeover takes place when event input switches "OFF → ON" and "ON → OFF".



### ■ Event input allocation

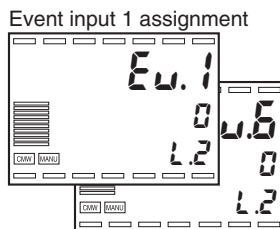

- Function settings for event input using external contact input are configured using "Event input allocation 1 to 6".
- On a multi-point input type, assignment data can be set for channels 2 and higher as appropriate for the number of channels.

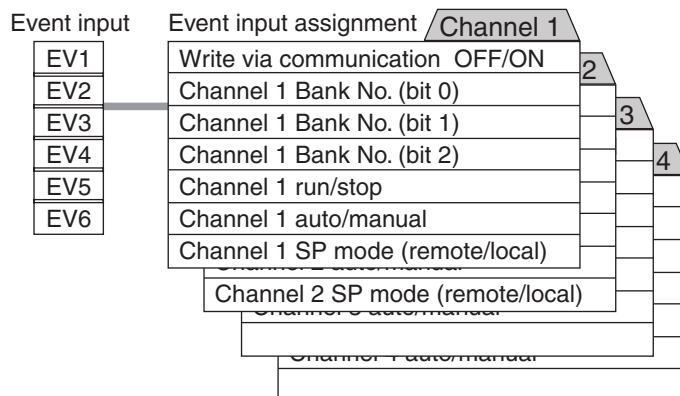

### ● Communication write OFF/ON

- When the event input is ON, setting data can be written with the communication function and the "CMW" indicator lights up. The content of the event input is reflected in "Communication OFF/ON" (Adjustment level).
- This setting data is an operation command that is common to all channels.
- Operation is as follows based on the event input ON/OFF state.

| Event input | Description                 |
|-------------|-----------------------------|
| OFF         | Write via communication OFF |
| ON          | Write via communication ON  |

### ● Bank No. (Bits 0 to 2)

- The bank number is specified by the event input ON/OFF state. The content of the event input is reflected in "Bank No." (Adjustment level).
- This setting data is an operation command that is particular to a single channel.
- Operation is as follows based on the event input ON/OFF state.

| Event input         |                     |                     | Description   |
|---------------------|---------------------|---------------------|---------------|
| Bank No.<br>(Bit 0) | Bank No.<br>(Bit 1) | Bank No.<br>(Bit 2) |               |
| OFF                 | OFF                 | OFF                 | Run Bank No.0 |
| ON                  | OFF                 | OFF                 | Run Bank No.1 |
| OFF                 | ON                  | OFF                 | Run Bank No.2 |
| ON                  | ON                  | OFF                 | Run Bank No.3 |
| OFF                 | OFF                 | ON                  | Run Bank No.4 |
| ON                  | OFF                 | ON                  | Run Bank No.5 |
| OFF                 | ON                  | ON                  | Run Bank No.6 |
| ON                  | ON                  | ON                  | Run Bank No.7 |

- To use eight banks (Banks 0 to 7), 3 event input points are required.

### ● Run/Stop

- When the event input is ON, operation is stopped and the "STOP" indicator lights up. The content of the event input is reflected in "Run/Stop" (Run level).
- This setting data is an operation command that is particular to a single channel.
- Operation is as follows based on the event input ON/OFF state.

| Event input | Description |
|-------------|-------------|
| OFF         | Run         |
| ON          | Stop        |

### ● Auto / Manual

- When the event input is ON, the mode switches to manual and the "MANU" operation indicator lights up. The content of the event input is reflected in "Auto / Manual" (Run level).
- This setting data is an operation command that is particular to a single channel.
- Operation is as follows based on the event input ON/OFF state.

| Event input | Description |
|-------------|-------------|
| OFF         | Auto        |
| ON          | Manual      |

## ● SP mode

- This function is only effective when the control mode is control with remote SP.
- When the event input is ON, the remote SP (RSP) is used as the SP and the "RSP" operation indicator lights up. When the event input is OFF, the local SP (LSP) is used as the SP. The content of the event input is reflected in "SP mode" (Adjustment level).
- This setting data is an operation command that is particular to a single channel.
- Operation is as follows based on the event input ON/OFF state.

| Event input | Description    |
|-------------|----------------|
| OFF         | Local SP mode  |
| ON          | Remote SP mode |

| Symbol             | Setting data name             | Level (Display 3)               | Use                 |
|--------------------|-------------------------------|---------------------------------|---------------------|
| E <sub>1</sub> . * | Event input 1 to 6 assignment | Control initial setting 2 (L.2) | Specify event input |

\*: 1 to 6

## 5.8 Using transfer output

### Transfer output settings

#### Control / Transfer output assignment

- For transfer output, use an output that is not used for control output.
- Transfer output can be used to output one of the following 6 types of data as selected in "Control / Transfer output assignment". For more information, see "8.11 Control initial setting 2 level (L.2) Control / Transfer output 1 to 4 assignment (P.8-46).

SP, ramp SP, PV, MV (heat), MV (cool), valve opening

Note that the heating and cooling MVs can only be output from a standard type, and the valve opening can only be output from a position proportional type with a potentiometer connected.

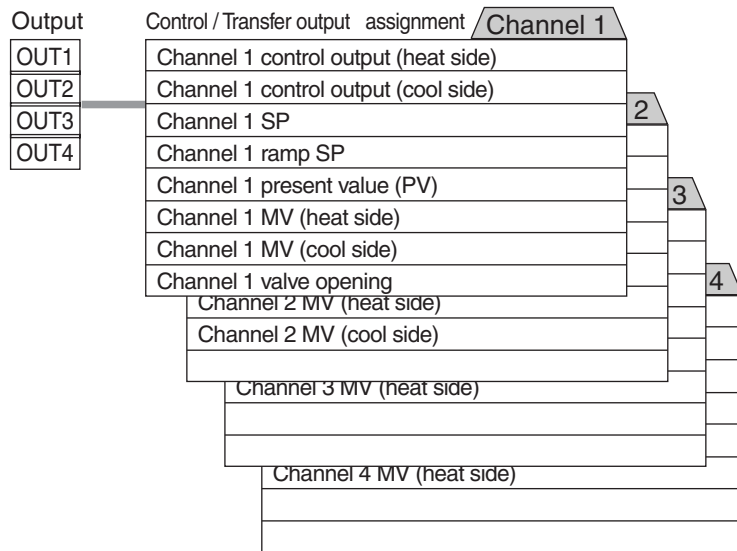

#### Transfer output scaling

- Scaling of the output value can be performed using "Transfer output upper limit" and "Transfer output lower limit". The upper-limit can be set to a smaller value than the lower limit to perform reverse scaling. The scale can be enlarged using the width between the upper-and lower-limits specified in the setting data. The following diagram shows an example of scaling the heating MV.

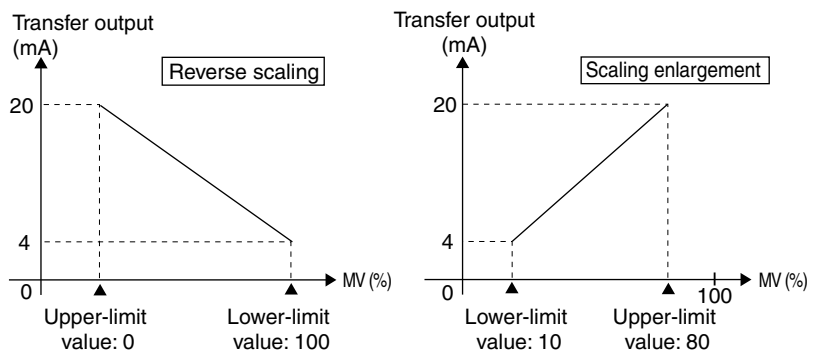

- If the "Input type", "Scaling display value 1, 2", "SP upper and lower limit", or "Temperature units" setting is changed when "SP" or "Ramp SP" is selected, the "Transfer output upper limit" and "Transfer output lower limit" will be respectively returned to the upper and lower limits of the setting range.
- If an input error occurs when the transfer output assignment is set to "PV", the transfer output changes to the upper limit and it changes to the lower limit in the case of reverse scaling.

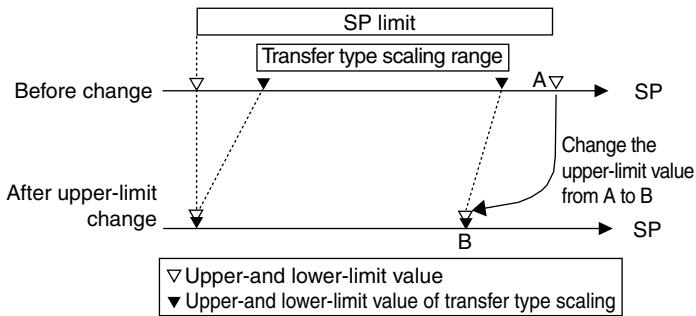

| Display characters | Setting data name                           | Level (Display 3)               | Use                               |
|--------------------|---|---------------------------------|-----------------------------------|
| ōūē. *             | Control / Transfer output 1 to 4 assignment | Control initial setting 2 (L.2) | Specify Control / Transfer output |
| ērH. *             | Transfer output 1 to 4 upper limit          | Control initial setting 2 (L.2) | Transfer output scaling           |
| ērL. *             | Transfer output 1 to 4 lower limit          | Control initial setting 2 (L.2) |                                   |

\*: 1 to 4



## 5.9 Using communication functions

### ■ Setting communication parameters

Communication parameters are set in the Communications setting level.

The parameters and settings are shown in the following table.

Initial settings are highlighted

| Display characters | Setting data name         | Setting values                          | Description             |
|--------------------|---------------------------|---|-------------------------|
| <i>P5E1</i>        | Protocol selection        | <b>F/F</b> / <i>n̄dd</i>                | CompoWay/F, Modbus      |
| <i>U-n̄</i>        | Communication Unit No.    | 0, <b>1</b> to 99                       | 0 to 99                 |
| <i>bP5</i>         | Communications speed      | <b>9.6</b> / 19.2 / 38.4                | 9.6/19.2/38.4 (k bit/s) |
| <i>LEn</i>         | Communication data length | <b>7</b> / 8 (bit)                      | 7/8 (bit)               |
| <i>5b̄t</i>        | Communication stop bit    | 1 / <b>2</b>                            | 1/2                     |
| <i>PrtY</i>        | Communication parity      | <i>n̄n̄E</i> / <b>EVEN</b> / <i>odd</i> | None/Even/Odd           |
| <i>5b̄t</i>        | Transmission wait time    | 0 - <b>20</b> - 99                      | 0 to 99 (ms)            |

#### Protocol selections (*P5E1*)

The communication protocol can be set to CompoWay/F (Omron's unified protocol for general purpose serial communication), or Modbus (based on RTU Mode of Modbus Protocol (Specifications: PI-MBUS-300 Rev.I) of Modicon Inc.).

#### Communication Unit No. (*U-n̄*)

When performing communication with a host computer, a unit number must be set in each controller to allow the host computer to recognize it. Any number from 0 to 99 can be set. The unit number is initially set to 1. When using multiple controllers, make sure that no units have the same unit number or communication will not take place correctly. After setting a unit number, turn off the power and then turn it on again to make the new unit number take effect.

#### Communications speed (*bP5*)

Set the communications speed for communication with a host computer. The following speeds are available:

9.6 (9,600 bit/s), 19.2 (19,200 bit/s), 38.4 (38,400 bit/s)

After setting the speed, turn off the power and then turn it on again to make the new speed setting take effect.

#### Communication data length (*LEn*)

The communication data length can set to 7 bits or 8 bits.

#### Communication stop bit (*5b̄t*)

The communication stop bit can be set to 1 or 2.

#### Communication parity (*PrtY*)

The communication parity can be set to None (*n̄n̄E*), Even (**EVEN**), or Odd (*odd*).

#### Transmission wait time (*5b̄t*)

After changing the transmission wait time, perform a software reset or turn the power off and then on to make the new setting take effect.

**Hint**

For information on communication procedures, see "Section 6 Communication (CompoWay/F)" or "Section 7 Communication (Modbus)" (P. 7-1) depending on the communication protocol you are using.

**Operation procedure**

Before performing communication, follow the steps below to set the communication unit number, communications speed, and other communication parameters.

1. Hold down the  for 3 seconds to move from "RUN level" to "Initial setting level".
2. Press the  key to move from "Input initial setting level" to "Communications setting level".
3. Press the  key to scroll through the setting item as shown at left.
4. Press the   keys to change a setting.

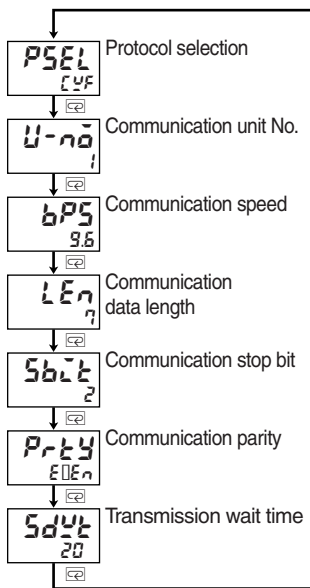

Configure communication setting data in accordance with the other computers

**Write via communication**

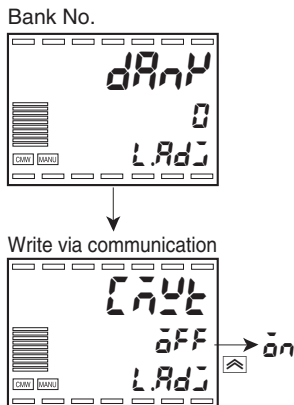

To allow a host computer to write setting data to a controller, set "Write via communication" (Adjustment level) to "on: Enabled".

1. Press the  key less than 1 second to move from "RUN level" to "Adjustment level".
2. Press the  key to set "Write via communication to "on".

**Important**

Setting data can be written 100,000 times. If you will be writing setting data frequently, select "RAM write mode" (Special function setting level).



# Section 6 Communication (CompoWay/F)

|      |   |      |
|------|---|------|
| 6.1  | Communication method.....                                 | 6-2  |
| 6.2  | Frames (Communication/CompoWay/F).....                    | 6-4  |
| 6.3  | FINS-mini text.....                                       | 6-6  |
| 6.4  | Variable areas.....                                       | 6-7  |
| 6.5  | Reading the variable area.....                            | 6-9  |
| 6.6  | Writing to the variable area.....                         | 6-10 |
| 6.7  | Operation commands (Communication/CompoWay/F) ...         | 6-11 |
| 6.8  | Setting areas .....                                       | 6-13 |
| 6.9  | Commands and responses<br>(Communication/CompoWay/F)..... | 6-14 |
| 6.10 | Program example .....                                     | 6-32 |

## 6.1 Communication method

### ■ CompoWay/F communication protocol

#### Supplement

The communication function is used by creating a program on the host computer. As such, the explanations in this section are from the perspective of the host computer.

For example, "Read/Write" refers to the host computer reading or writing to the E5AR/ER.

CompoWay/F is OMRON's unified protocol for general purpose serial communication. Featuring a unified frame format and commands that are compliant with FINS, which has a record of successful use with OMRON programmable controllers, CompoWay/F makes communication easy between multiple components and a computer.

#### FINS (Factory Interface Network Service)

This is a protocol for message communication between controllers on an OMRON factory automation network.

### ■ Communication specifications

|                         |  |
|-------------------------|--|
| Transfer connection:    | Multi-point  |
| Communication method:   | RS-485 (2-wire half duplex)  |
| Synchronization method: | Start-stop   |
| Baud rate:              | 9.6 k/19.2 k/38.4 k bit/s  |
| Send code:              | ASCII  |
| Data length:            | 7/8 bits   |
| Stop bit length:        | 1/2 bits   |
| Error detection:        | Vertical parity (None/Even/Odd)<br>BCC (Block Check Character)<br>Start-stop synchronized data configuration |
| Flow control:           | None   |
| Interface:              | RS-485   |
| Retry function:         | None   |

\* Initial settings are shaded.

### ■ Transfer protocol (Communication/CompoWay/F)

The host computer sends a command frame, and the E5AR/ER sends a response frame based on the content of the command frame. One response frame is sent in response to one command frame.

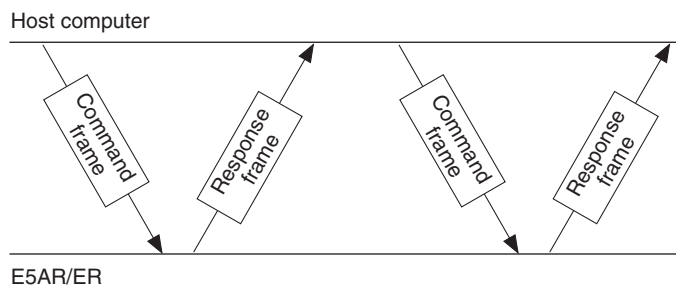

The exchange between the command frame and response frame is explained below.

After receiving a response from the controller, the host computer waits at least 5 ms before sending the next command.

When writing multiple sets of setting data in a row, such as when writing to the variable area or performing a compound write, controllability may be affected. Pay attention to the following points:

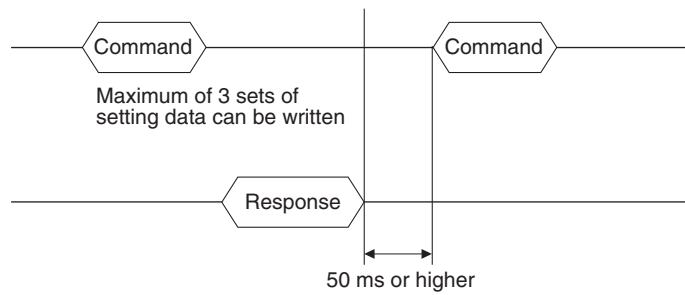

## 6.2 Frames (Communication/CompoWay/F)

Based on CompoWay/F protocol, commands from the host computer and responses from the E5AR/ER take the form of frames.

The data comprising command frames and response frames are explained below.

In the following explanation, an "H" following a numeric value (for example 02H) indicates that the value is a hexadecimal number. A number or letters enclosed in quotation marks (for example "00") is an ASCII character.

### ■ Command frame

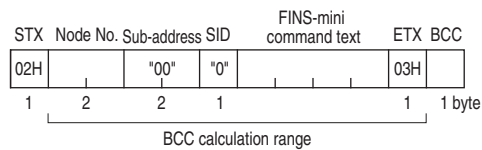

|                           |   |
|---------------------------|---|
| STX                       | Code that indicates the beginning of the communication frame (02H).<br>Be sure to set this code in the leading byte.  |
| Node No.                  | This number specifies the destination.<br>Specify the Unit No. of the E5AR/ER.<br>When broadcasting to all units, specify "XX".<br>Responses are not sent to a broadcast. |
| Sub-address               | Not used on the E5AR/ER. Be sure to set to "00".  |
| SID<br>(Service ID)       | Not used on the E5AR/ER. Be sure to set to "0".   |
| FINS-mini<br>Command text | The text of the command.  |
| ETX                       | Code that indicates the end of the text (03H).  |
| BCC                       | Block Check Character.<br>This stores the result of the BCC calculation from Node No. to EXT.   |

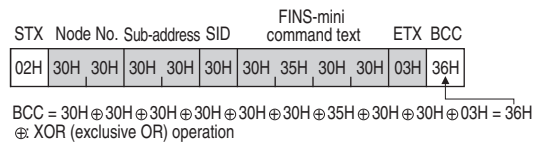

## ■ Response frame

### Supplement

A response is not sent to command frames that do not end with ETX.BCC characters.

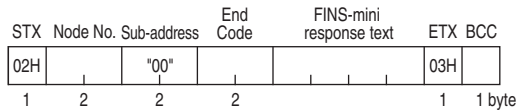

|                         |   |
|-------------------------|---|
| STX                     | Code that indicates the beginning of the communication frame (02H).<br>Be sure to set this code in the leading byte.    |
| Node No.                | The number that was specified in the command frame is repeated here.<br>This is the Unit No. of the responding E5AR/ER. |
| Sub-address             | Not used on the E5AR/ER. Set to "00".   |
| End code                | Returns the result of the command executed as instructed by the command frame.  |
| FINS-mini Response text | Text of the response  |
| ETX                     | Code that indicates the end of the text (03H).  |
| BCC                     | Block Check Character.<br>This stores the result of the BCC calculation from Node No. to EXT.                           |

### End codes (Communication/CompoWay/F)

| End code | Name               | Description   | Error detection order of priority |
|----------|--------------------|---|-----------------------------------|
| "0F"     | FINS command error | Could not execute the specified FINS command.   | 8                                 |
| "10"     | Parity error       | Sum of bits that are "1" in received data does not agree with the set communication parity value.   | 2                                 |
| "11"     | Framing error      | Stop bit of command frame characters is "0".  | 1                                 |
| "12"     | Overrun error      | Attempted to transfer new data because received data buffer is already full.  | 3                                 |
| "13"     | BCC error          | Calculated BCC different from received BCC.   | 5                                 |
| "14"     | Format error       | Characters other than "0" to "9" or "A" to "F" in FINS-mini command text. In the case of an echo-back test, when data other than the test data is sent.<br>No SID and FINS-mini command text, or no FINS-mini command text.<br>"MRC/SRC" not correct in FINS-mini command text. | 7                                 |
| "16"     | Sub-address error  | No sub-address, SID, or FINS-mini command text; or sub-address less than 2 characters and no SID and FINS-mini command text.  | 6                                 |
| "18"     | Frame length error | The received frame exceeds the required number of bytes.  | 4                                 |
| "00"     | Normal end         | Command was executed normally without error.  | None                              |



## 6.3 FINS-mini text

The FINS-mini command text and FINS-mini response text form the body of command/response communication.

FINS-mini command text and FINS-mini response text are configured as follows.

**Command text** FINS-mini command text consists of an MRC (main request code) and an SRC (sub request code), followed by the required data.

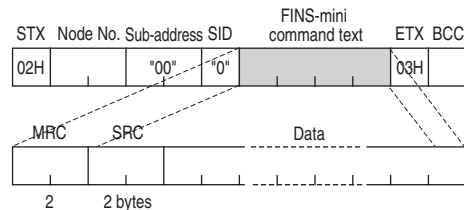

**Response text** FINS-mini response text consists of the MRC and SRC, followed by an MRES (main response code) and SRES (sub response code), and then the required data.

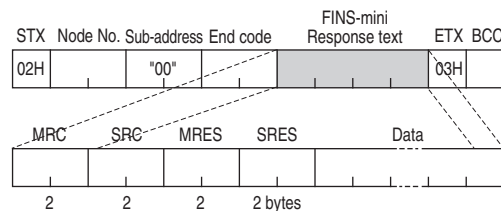

If the specified FINS-mini command was not successfully executed, the response will only contain the MRC, SRC, MRES and SRES.

### List of FINS-mini service commands (communication/CompoWay/F)

| MRC  | SRC  | Service name  | Description   |
|------|------|---|---|
| "01" | "01" | Monitor value / setting data read                             | Reads monitor values / setting data.  |
| "01" | "02" | Monitor value / setting data write                            | Writes monitor values / setting data.   |
| "01" | "04" | Monitor value / setting data compound read                    | Performs multiple reads of monitor values / setting data.   |
| "01" | "13" | Monitor value / setting data compound write                   | Performs multiple writes of monitor values / setting data.  |
| "01" | "10" | Monitor value / setting data compound stored read             | Sequentially reads contents of addresses specified in "monitor value / setting data compound read store". |
| "01" | "11" | Monitor value / setting data compound read store (write)      | Specifies addresses to be read using "monitor value / setting data compound stored read".                 |
| "01" | "12" | Monitor value / setting data compound read store check (read) | Reads the contents stored using "variable area compound read store".                                      |
| "05" | "03" | Machine attribute read  | Reads the model and other attributes.   |
| "06" | "01" | Controller status read  | Reads the operation status.   |
| "08" | "01" | Echo-back test  | Performs an echo-back test.   |
| "30" | "05" | Operation command   | Commands such as Run/Stop, AT Execute / Cancel, and "Move to setting area 1".                             |

## 6.4 Variable areas

The area used for data exchange when communicating with the E5AR/ER is called the "variable area". The PV is read and various setting data are read and written using the variable area of the E5AR/ER.

Operation commands and reading of machine attributes do not use the variable area.

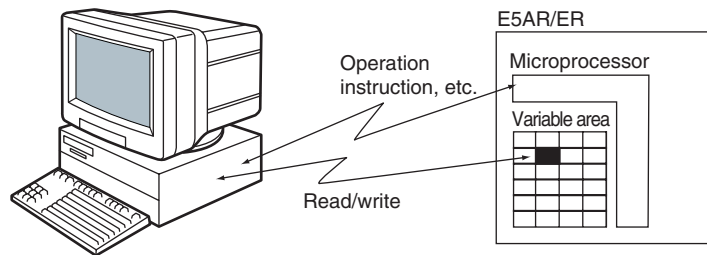

A variable area is accessed by specifying the position of a variable within the variable area using the variable type and address.

### ● Variable types

Variable types in variable areas are as follows:

| Variable type | Description                     | Area                                 |
|---------------|---------------------------------|--------------------------------------|
| C4            | Communication monitor           | Setting area 0<br>(during operation) |
| C5            | Protect level                   |                                      |
| C6            | RUN level                       |                                      |
| C7            | Adjustment level                |                                      |
| C8            | Adjustment level 2              |                                      |
| C9            | Bank setting level              |                                      |
| CA            | PID setting level               |                                      |
| CB            | Approximation setting level     |                                      |
| CC            | Input initial setting level     | Setting area 1<br>(during stop)      |
| CD            | Control initial setting level   |                                      |
| CE            | Control initial setting 2 level |                                      |
| CF            | Alarm setting level             |                                      |
| D0            | Display adjustment level        |                                      |
| D1            | Communications setting level    |                                      |
| D2            | Special function setting level  |                                      |
| D3            | Expansion control setting level |                                      |

### ● Addresses (Communication/ CompoWay/F)

Each variable type has an address. Addresses are 2 bytes long and written in hexadecimal. Addresses are assigned according to units of access size. Each address consists of a "channel identifier" and an "in-area address".

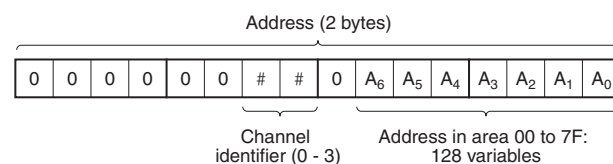

**Channel identifier**

For multi-point input types that require settings for channels 2 to 4, specify 1 to 3 to identify the channels.

On single-input types, only "0: Channel 1" can be specified.

| Channel identifier | Channel   |
|--------------------|-----------|
| 0                  | Channel 1 |
| 1                  | Channel 2 |
| 2                  | Channel 3 |
| 3                  | Channel 4 |

**In-area address**

This is a number that is assigned to each set of data in the variable area. Addresses are assigned in order beginning from the first set.

For more information on addresses, see "Appendix Setting list" (P.A-6). Note that the addresses indicated in the setting list are addresses of channel 1.

For example, to specify an address of channel 2, add 0100 to the address in the setting list. For channel 3 add 0200, and for channel 4 add 0300.

- **Number of elements**

The number of elements is expressed as a 2-byte hexadecimal number. The specification range for the number of elements varies depending on the command. See "6.9 Commands and responses (Communication/CompoWay/F)" (P.6-14) for more information.

For example, if the number of elements is 0010, the first 16 elements of data (H'10) from the address are specified.

- **Set values**

Values read and written to the variable area are expressed in hexadecimal and disregard the decimal point position (negative values are expressed as a two's complement).

Example: D'105.0 → H'0000041A

The variable is an 8-digit number in hexadecimal. Negative values are expressed as a two's complement. The decimal is disregarded.

For example, if the PV of the E5AR/ER is 105.0, it will be read as H'0000041A (105.0 → 1050 → H'0000041A).

## 6.5 Reading the variable area

The data area is read by setting the required data in the following FINS-mini command text format.

Command

### FINS-mini command text

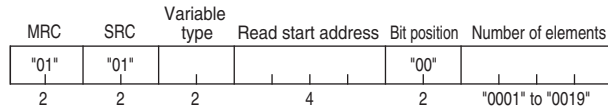

| Data name             | Explanation  |
|-----------------------|--|
| MRC/SRC               | Specifies the FINS-mini monitor value/setting data read command.                               |
| Variable type         | Specify a variable type.   |
| First address of read | Specify the address for the beginning of the read.   |
| Bit position          | Not used on the E5AR/ER. Specify "00".   |
| Number of elements    | Specifies the number of variables to read (max. of 25 (H'19)). Not needed for a compound read. |

Response

### FINS-mini response text

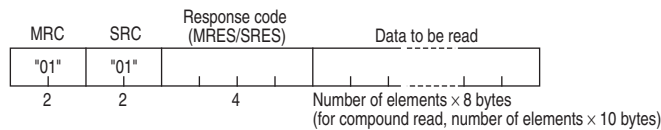

| Data name     | Explanation                              |
|---------------|--|
| MRC/SRC       | The FINS-mini command text appears here. |
| Response code | Result of execution of the command.      |
| Read data     | Data that was read.                      |

### Response codes

| Response code | Error name               | Explanation  |
|---------------|--------------------------|--|
| "1001"        | Command length too long  | The command is too long.   |
| "1002"        | Command length too short | The command is too short.  |
| "1101"        | Area type error          | Incorrect variable type.   |
| "110B"        | Response length too long | Number of elements > 25 (H'0019).  |
| "1100"        | Parameter error          | Specified bit position is other than "00".                                       |
| "2203"        | Operation error          | Unit error, unit change, display unit error, internal non-volatile memory error. |
| "0000"        | Normal end               |  |

## 6.6 Writing to the variable area

Write to the data area by setting the required data in the following FINS-mini command text format.

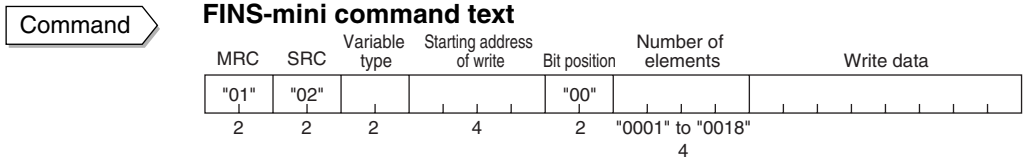

| Data name              | Explanation   |
|------------------------|---|
| MRC/SRC                | Specifies the FINS-mini monitor value/setting data write command.                                     |
| Variable type          | Specify a variable type.  |
| First address of write | Specify the address for the beginning of the write.   |
| Bit position           | Not used on the E5AR/ER. Specify "00".  |
| Number of elements     | Specifies the number of variables to be written (max. of 25 (H'19)). Not needed for a compound write. |
| Write data             | Enter data to be written.   |

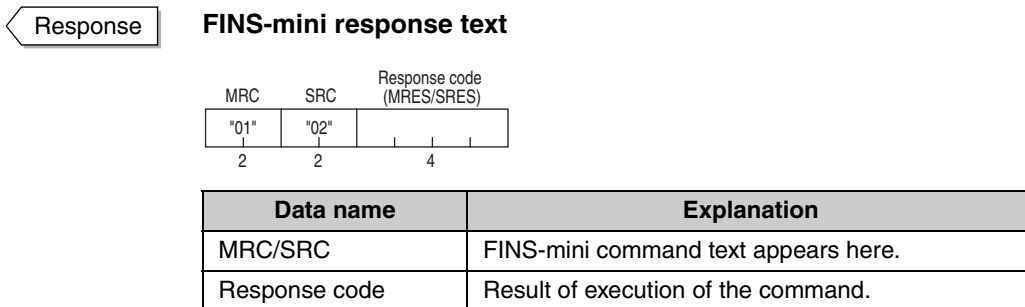

### Response codes

| Response code | Error name                                    | Explanation   |
|---------------|---|---|
| "1002"        | Command length too short                      | The command is too short.   |
| "1101"        | Area type error                               | Incorrect variable type.  |
| "1003"        | Number of elements / Data number do not agree | The specified number of elements does not agree with the actual number of data elements.  |
| "1100"        | Parameter error                               | Bit position specification other than "00".<br>Written data was outside of setting range.   |
| "2203"        | Operation error                               | Write via communication is disabled.<br>Write to setting area 1 was attempted from setting area 0.<br>Write to setting data of protect level was attempted from other than protect level.<br>AT is running.<br>Calibration level in progress.<br>Unit error, unit change, display unit error, internal non-volatile memory error. |
| "0000"        | Normal end                                    |   |

## 6.7 Operation commands (Communication/CompoWay/F)

Operation commands are sent using the following FINS-mini command text format.

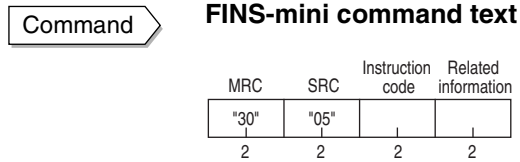

| Data name           | Explanation                                 |
|---------------------|---|
| MRC/SRC             | Specify the FINS-mini operation command.    |
| Operation code      | Specify an operation code.                  |
| Related information | Specify information related to the command. |

Operation commands for the E5AR/ER are shown in the following.

| Operation code | Description             | Related information |  |
|----------------|-------------------------|---------------------|--|
|                |                         | Higher Byte         | Lower Byte   |
| 00             | Write via communication | 0 *1                | 0: OFF (Disabled)<br>1: ON (Enabled)                     |
| 01             | Run/Stop                | 0 to 3, F *2        | 0: Run 1: Stop   |
| 02             | Bank change             | 0 to 3, F *2        | 0 to 7: Bank 0 to 7                                      |
| 03             | AT run                  | 0 to 3, F *2        | 0: Currently selected PID Set No.<br>1 to 8: PID Set No. |
| 04             | Write mode              | 0 *1                | 0: Backup mode<br>1: RAM write mode                      |
| 05             | RAM data save           | 0 *1                | 0  |
| 06             | Software reset          | 0 *1                | 0  |
| 07             | Move to setting area 1  | 0 *1                | 0  |
| 08             | Move to protect level   | 0 *1                | 0  |
| 09             | Auto / Manual           | 0 to 3, F *2        | 0: Auto mode<br>1: Manual mode                           |
| 0A             | AT stop                 | 0 to 3, F *2        | 0: Stop  |
| 0B             | Initialize settings     | 0 *1                | 0  |
| 0C             | Cancel latch            | 0 to 3, F *2        | 0  |
| 0D             | SP mode                 | 0 to 3, F *2        | 0: LSP<br>1: RSP   |

\*1: Operates for all channels.

\*2: Specify for each channel

0: CH1, 1: CH2, 2: CH3, 3: CH4, F: All channels

\*: A software reset will not respond (no service PDU response).

\*: When all channels are specified, only enabled channels will respond and processing will begin from Channel 1. If an error is detected on any one channel, an "Operation error" will result. If all channels end normally, "Normal end" results.



When cascade control is selected for the control mode, specify channel 2 commands for the following operation commands:

- Run/Stop
  - Auto / Manual
  - SP mode
- Cascade open / closed

Response

**FINS-mini response text**

| MRC  | SRC  | Response code<br>(MRES/SRES) |
|------|------|------------------------------|
| "30" | "05" |                              |
| 2    | 2    | 4                            |

| Data name     | Explanation                          |
|---------------|--------------------------------------|
| MRC/SRC       | FINS-mini command text appears here. |
| Response code | Result of execution of the command.  |

**Response codes**

| Response code | Error name               | Explanation  |
|---------------|--------------------------|--|
| "1001"        | Command length too long  | The command is too long.   |
| "1002"        | Command length too short | The command is too short.  |
| "1100"        | Parameter error          | Operation code or related information is not correct.  |
| "2203"        | Operation error          | Unable to execute because write via communication is disabled.<br>Unable to execute operation command.<br>For more information, see corresponding operation command explanation in "6.9 Commands and responses (Communication/CompoWay/F)".<br>Unit error, unit change, display unit error, internal non-volatile memory error |
| "0000"        | Normal end               |  |

## 6.8 Setting areas

The E5AR/ER has two setting areas for communication: Setting area 0 and setting area 1.

In setting area 0, control continues.

As such, setting area 0 makes it possible to perform operations that require control to be in progress, such as reading the PV, writing an SP, and run/stop, as well as operations that do not interfere with control. On the other hand, operations that may change control such as writing initial setting data cannot be performed. (Note that setting data that cannot be written can still be read.)

In setting area 1, control is stopped.

This makes it possible to perform operations such as writing initial setting data which are not possible in setting area 0.

When the power is turned on, setting area 0 is selected. To access setting area 1, use the "Move to setting area 1" operation command. To return to setting area 0 from setting area 1, turn off the power or use the "Software reset" operation command.

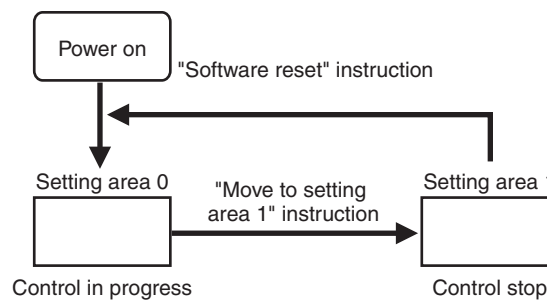

| Variable type | Description                     | Area                               |
|---------------|---------------------------------|------------------------------------|
| C4            | Communication monitor           | Setting area 0<br>(During control) |
| C5            | Protect level                   |                                    |
| C6            | RUN level                       |                                    |
| C7            | Adjustment level                |                                    |
| C8            | Adjustment level 2              |                                    |
| C9            | Bank setting level              |                                    |
| CA            | PID setting level               |                                    |
| CB            | Approximation setting level     |                                    |
| CC            | Input initial setting level     | Setting area 1<br>(Control stop)   |
| CD            | Control initial setting level   |                                    |
| CE            | Control initial setting 2 level |                                    |
| CF            | Alarm setting level             |                                    |
| D0            | Display adjustment level        |                                    |
| D1            | Communications setting level    |                                    |
| D2            | Special function setting level  |                                    |
| D3            | Expansion control setting level |                                    |



## 6.9 Commands and responses (Communication/CompoWay/F)

The E5AR/ER provides a set of applied commands that make use of variable area read/write commands, operation commands, and other services provided by the CompoWay/F communication protocol.

E5AR/ER applied commands are explained below.

### ■ Monitor value read (Communication/CompoWay/F)

Command

| MRC  | SRC  | Variable type | Address | Bit position | Number of elements |
|------|------|---------------|---------|--------------|--------------------|
| "01" | "01" |               |         | "00"         | "0001"             |

| Variable type | Monitor value                     |                                   | Monitor value                     |                                   |   |                                   |
|---------------|-----------------------------------|-----------------------------------|-----------------------------------|-----------------------------------|---|-----------------------------------|
|               | Address                           | Ch                                | Address                           | Ch                                |   |                                   |
| "C0"          | "0000"                            | 1                                 | PV                                | "0200"                            | 3 | PV                                |
|               | "0001"                            |                                   | Status                            | "0201"                            |   | Status                            |
|               | "0002"                            |                                   | Internal SP                       | "0202"                            |   | Internal SP                       |
|               | "0003"                            |                                   | None                              | "0203"                            |   | None                              |
|               | "0004"                            |                                   | MV monitor (heat)                 | "0204"                            |   | MV monitor (heat)                 |
|               | "0005"                            | MV monitor (cooling)              | "0205"                            | MV monitor (cooling)              |   |                                   |
|               | "0100"                            | 2                                 | PV                                | "0300"                            | 4 | PV                                |
|               | "0101"                            |                                   | Status                            | "0301"                            |   | Status                            |
|               | "0102"                            |                                   | Internal SP                       | "0302"                            |   | Internal SP                       |
|               | "0103"                            |                                   | None                              | "0303"                            |   | None                              |
| "0104"        | MV monitor (heat)                 |                                   | "0304"                            | MV monitor (heat)                 |   |                                   |
| "0105"        | MV monitor (cooling)              | "0305"                            | MV monitor (cooling)              |                                   |   |                                   |
| "C1"          | "0003"                            | 1                                 | SP *1                             | "0203"                            | 3 | SP *1                             |
|               | "0004"                            |                                   | Bank 0: Alarm value 1             | "0204"                            |   | Bank 0: Alarm value 1             |
|               | "0005"                            |                                   | Bank 0: Alarm value 1 upper limit | "0205"                            |   | Bank 0: Alarm value 1 upper limit |
|               | "0006"                            |                                   | Bank 0: Alarm value 1 lower limit | "0206"                            |   | Bank 0: Alarm value 1 lower limit |
|               | "0007"                            |                                   | Bank 0: Alarm value 2             | "0207"                            |   | Bank 0: Alarm value 2             |
|               | "0008"                            | Bank 0: Alarm value 2 upper limit | "0208"                            | Bank 0: Alarm value 2 upper limit |   |                                   |
|               | "0009"                            | Bank 0: Alarm value 2 lower limit | "0209"                            | Bank 0: Alarm value 2 lower limit |   |                                   |
|               | "0103"                            | 2                                 | SP *1                             | "0303"                            | 4 | SP *1                             |
|               | "0104"                            |                                   | Bank 0: Alarm value 1             | "0304"                            |   | Bank 0: Alarm value 1             |
|               | "0105"                            |                                   | Bank 0: Alarm value 1 upper limit | "0305"                            |   | Bank 0: Alarm value 1 upper limit |
| "0106"        | Bank 0: Alarm value 1 lower limit |                                   | "0306"                            | Bank 0: Alarm value 1 lower limit |   |                                   |
| "0107"        | Bank 0: Alarm value 2             |                                   | "0307"                            | Bank 0: Alarm value 2             |   |                                   |
| "0108"        | Bank 0: Alarm value 2 upper limit | "0308"                            | Bank 0: Alarm value 2 upper limit |                                   |   |                                   |
| "0109"        | Bank 0: Alarm value 2 lower limit | "0309"                            | Bank 0: Alarm value 2 lower limit |                                   |   |                                   |
| "C4"          | "0000"                            | 1                                 | Version                           | "0200"                            | 3 | Version                           |
|               | "0001"                            |                                   | Modification type                 | "0201"                            |   | Modification type                 |
|               | "0002"                            |                                   | PV                                | "0202"                            |   | PV                                |
|               | "0003"                            |                                   | Internal SP                       | "0203"                            |   | Internal SP                       |
|               | "0004"                            |                                   | Bank No.monitor                   | "0204"                            |   | Bank No.monitor                   |
|               | "0005"                            |                                   | PID Set No.monitor                | "0205"                            |   | PID Set No.monitor                |
|               | "0006"                            | Status                            | "0206"                            | Status                            |   |                                   |
|               | "0100"                            | 2                                 | Version                           | "0300"                            | 4 | Version                           |
|               | "0101"                            |                                   | Modification type                 | "0301"                            |   | Modification type                 |
|               | "0102"                            |                                   | PV                                | "0302"                            |   | PV                                |
|               | "0103"                            |                                   | Internal SP                       | "0303"                            |   | Internal SP                       |
|               | "0104"                            |                                   | Bank No.monitor                   | "0304"                            |   | Bank No.monitor                   |
| "0105"        | PID Set No.monitor                |                                   | "0305"                            | PID Set No.monitor                |   |                                   |
| "0106"        | Status                            | "0306"                            | Status                            |                                   |   |                                   |

\*1 Local SP of Bank No. that is selected and running.

This command is used to read the PV, status, and other monitor values. The number of elements can be set from 0002 to 0019 to allow reading of monitor values in contiguous addresses.

When used in setting area 1, the response for the PV and internal SP is "0" and the response for the status is as indicated in the notes in "Appendix Setting list Status" (P.A-8).

Response

| MRC  | SRC  | Response code | Data          |
|------|------|---------------|---------------|
| "01" | "01" | "0000"        | Monitor value |

Response codes: The above indicates a normal end. For the response codes, see "6.5 Reading the variable area" (P.6-9).

## ■ Setting data read (Communication/CompoWay/F)

Command

| MRC  | SRC  | Variable type | Address | Bit position | Number of elements |
|------|------|---------------|---------|--------------|--------------------|
| "01" | "01" |               |         | "00"         | "0001"             |

| Variable type | Address          | Setting data |                                 |
|---------------|------------------|--------------|---------------------------------|
|               |                  | Ch           | Explanation                     |
| "C4"          | "0000" to "007F" | 1            | Setting data of setting area 0  |
| "C5"          |                  |              | Protect level                   |
| "C6"          | "0100" to "017F" | 2            | RUN level                       |
| "C7"          |                  |              | Adjustment level                |
| "C8"          | "0200" to "027F" | 3            | Adjustment level 2              |
| "C9"          |                  |              | Bank setting level              |
| "CA"          | "0300" to "037F" | 4            | PID setting level               |
| "CB"          |                  |              | Approximation setting level     |
| "CC"          | "0000" to "0039" | 1            | Setting data of setting area 1  |
| "CD"          | "0100" to "0139" | 2            | Input initial setting level     |
| "CE"          |                  |              | Control initial setting level   |
| "CF"          | "0200" to "0239" | 3            | Control initial setting 2 level |
| "D0"          |                  |              | Alarm setting level             |
| "D1"          | "0300" to "0339" | 4            | Display adjustment level        |
| "D2"          |                  |              | Communications setting level    |
| "D3"          |                  |              | Special function setting level  |
|               |                  |              | Expansion control setting level |

This command is used to read setting data. The number of elements can be set from 0002 to 0019 to allow successive reading of 2 to 25 items of setting data in contiguous addresses.

To specify the variable type or address, see "Appendix Setting list" (P.A-6). The upper limit of an address will vary depending on the variable type.

This command can be used in both setting area 0 and setting area 1.

When used in setting area 1, the response for the remote SP monitor, ramp SP monitor, and valve opening monitor is "0" and the response for the status is as indicated in the notes in "Appendix Setting list Status" (P.A-8).

Response

| MRC  | SRC  | Response code | Data         |
|------|------|---------------|--------------|
| "01" | "01" | "0000"        | Setting data |

Response codes: The above indicates a normal end. For the response codes, see "6.5 Reading the variable area" (P.6-9).

## ■ Monitor value / setting data compound read (Communication/CompoWay/F)

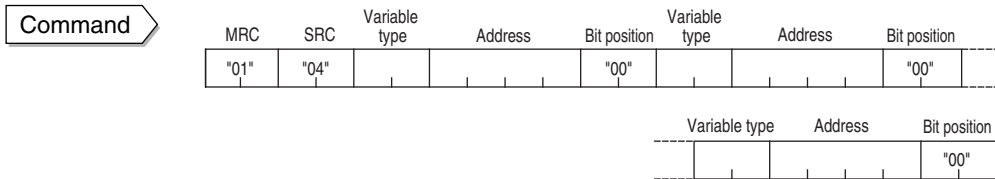

| Variable type | Address          | Setting data |                                |
|---------------|------------------|--------------|--------------------------------|
|               |                  | Ch           | Explanation                    |
| "C4"          | "0000"           | 1            | Monitor values                 |
|               | "0100"           | 2            |                                |
|               | "0200"           | 3            |                                |
|               | "0300"           | 4            |                                |
| "C5" to "CB"  | "0000" to "007F" | 1            | Setting data of setting area 0 |
|               | "0100" to "017F" | 2            |                                |
|               | "0200" to "027F" | 3            |                                |
|               | "0300" to "037F" | 4            |                                |
| "CC" to "D3"  | "0000" to "0039" | 1            | Setting data of setting area 1 |
|               | "0100" to "0139" | 2            |                                |
|               | "0200" to "0239" | 3            |                                |
|               | "0300" to "0339" | 4            |                                |

Multiple monitor values or setting data can be read by sending a single command. Up to 20 items can be read even if the addresses are not contiguous.

To specify the variable type or address, see "Appendix Setting list" (P.A-6). The upper limit of an address will vary depending on the variable type.

This command can be used in both setting area 0 and setting area 1.

If an area type error or a setting data error occurs in any of the data being read, no data will be read.

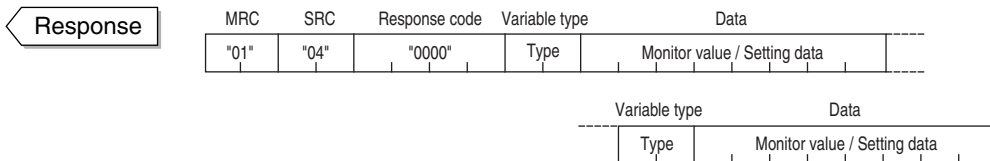

Response codes: The above indicates a normal end. For the response codes, see "6.5 Reading the variable area" (P.6-9).

## ■ Protect level setting data write

| Command |      |               |         |              |                    |                            |
|---------|------|---------------|---------|--------------|--------------------|----------------------------|
| MRC     | SRC  | Variable type | Address | Bit position | Number of elements | Data                       |
| "01"    | "02" | "C5"          |         | "00"         | "0001"             | Protect level setting data |

| Address | Setting data                  |
|---------|-------------------------------|
| "0000"  | Operation adjustment protect  |
| "0001"  | Initial setting level protect |
| "0002"  | Setting change protect        |
| "0003"  | PF key protect                |

This command writes protect level setting data. See "5.5 Protecting settings" (P.5-24) for information on protect level.

This command is used in setting area 0. An error will result if used in setting area 1.

To use this command, use the "Write via communication" operation command to enable "Write via communication", and then use the "Move to protect level" operation command to move to "Protect level".

| Response |      |               |
|----------|------|---------------|
| MRC      | SRC  | Response code |
| "01"     | "02" | "0000"        |

Response codes: The above indicates a normal end. For the response codes, see "6.6 Writing to the variable area" (P.6-10).

## ■ Setting data write (Communication/CompoWay/F)

| Command |      |               |         |              |                    |              |
|---------|------|---------------|---------|--------------|--------------------|--------------|
| MRC     | SRC  | Variable type | Address | Bit position | Number of elements | Data         |
| "01"    | "02" |               |         | "00"         | "0001"             | Setting data |

| Variable type  | Address          | Setting data |  |                                 |
|--|------------------|--------------|--|---------------------------------|
|  |                  | Ch           | Explanation  |                                 |
| "C6"<br>"C7"<br>"C8"<br>"C9"<br>"CA"<br>"CB"                 | "0000" to "007F" | 1            | Setting data of setting area 0<br>RUN level                      |                                 |
|  | "0100" to "017F" | 2            | Adjustment level   |                                 |
|  | "0200" to "027F" | 3            | Adjustment level 2<br>Bank setting level                         |                                 |
|  | "0300" to "037F" | 4            | PID setting level<br>Approximation setting level                 |                                 |
| "CC"<br>"CD"<br>"CE"<br>"CF"<br>"D0"<br>"D1"<br>"D2"<br>"D3" | "0000" to "0039" | 1            | Setting data of setting area 1<br>Input initial setting level    |                                 |
|  | "0100" to "0139" | 2            | Control initial setting level<br>Control initial setting 2 level |                                 |
|  | "0200" to "0239" | 3            | Alarm setting level<br>Display adjustment level                  |                                 |
|  | "0300" to "0339" | 4            | Communications setting level<br>Special function setting level   |                                 |
|  |                  |              |  | Expansion control setting level |
|  |                  |              |  |                                 |

The above setting data is written. The number of elements can be set from 2 to 24 to write setting data of contiguous addresses.

To specify an address, see "Appendix Setting list" (P.A-6).

Setting data of setting area 1 can be written in setting area 1. An error will result if written in setting area 0.

To use this command, "Write via communication" must be enabled using the "Write via communication" operation command.

To store setting data of Operation, Adjustment, Adjustment 2, Bank setting, PID setting, or Approximation setting levels in non-volatile memory, select "Backup" with the "Write mode" command. If not set to "Backup", the setting data will not remain in memory when the power is turned off. For more information on the above levels, see "4.1 Setting levels and key operation" (P.4-2).

Response

|      |      |               |
|------|------|---------------|
| MRC  | SRC  | Response code |
| "01" | "02" | "0000"        |

Response codes: The above indicates a normal end. For the response codes, see "6.6 Writing to the variable area" (P.6-10).

## ■ Setting data compound write (Communication/CompoWay/F)

Command

|      |      |               |         |              |              |
|------|------|---------------|---------|--------------|--------------|
| MRC  | SRC  | Variable type | Address | Bit position | Data         |
| "01" | "13" |               |         | "00"         | Setting data |

|               |         |              |              |
|---------------|---------|--------------|--------------|
| Variable type | Address | Bit position | Data         |
|               |         | "00"         | Setting data |

| Variable type | Address          | Setting data |                                |
|---------------|------------------|--------------|--------------------------------|
|               |                  | Ch           | Explanation                    |
| "C5" to "CB"  | "0000" to "007F" | 1            | Setting data of setting area 0 |
|               | "0100" to "017F" | 2            |                                |
|               | "0200" to "027F" | 3            |                                |
|               | "0300" to "037F" | 4            |                                |
| "CC" to "D3"  | "0000" to "0039" | 1            | Setting data of setting area 1 |
|               | "0100" to "0139" | 2            |                                |
|               | "0200" to "0239" | 3            |                                |
|               | "0300" to "0339" | 4            |                                |

Multiple setting data items can be written by sending a single command. Up to 12 items can be written even if the addresses are not contiguous.

To specify the variable type or address, see "Appendix Setting list" (P.A-6).

Setting data of setting area 1 is written in setting area 1. An error will result if written in setting area 0.

To use this command, "Write via communication" must be enabled using the "Write via communication" operation command.

To store setting data of Operation, Adjustment, Adjustment 2, Bank setting, PID setting, or Approximation setting levels in non-volatile memory, select "Backup" with the "Write mode" command. If not set to "Backup", the setting data will not remain in memory when the power is turned off. For more information on the above levels, see "4.1 Setting levels and key operation" (P.4-2).

Response

|      |      |               |
|------|------|---------------|
| MRC  | SRC  | Response code |
| "01" | "13" | "0000"        |

Response codes: The above indicates a normal end. For the response codes, see "6.6 Writing to the variable area" (P.6-10).

### ■ Monitor value / setting data compound read store (write)

Command

|      |      |               |              |              |               |              |              |
|------|------|---------------|--------------|--------------|---------------|--------------|--------------|
| MRC  | SRC  | Variable type | Read address | Bit position | Variable type | Read address | Bit position |
| "01" | "11" |               |              | "00"         |               |              | "00"         |

|               |              |              |
|---------------|--------------|--------------|
| Variable type | Read address | Bit position |
|               |              | "00"         |

| Variable type | Address          | Setting data |                                |
|---------------|------------------|--------------|--------------------------------|
|               |                  | Ch           | Explanation                    |
| "C4"          | "0000"           | 1            | Monitor values                 |
|               | "0100"           | 2            |                                |
|               | "0200"           | 3            |                                |
|               | "0300"           | 4            |                                |
| "C5" to "CB"  | "0000" to "007F" | 1            | Setting data of setting area 0 |
|               | "0100" to "017F" | 2            |                                |
|               | "0200" to "027F" | 3            |                                |
|               | "0300" to "037F" | 4            |                                |
| "C5" to "D3"  | "0000" to "0039" | 1            | Setting data of setting area 1 |
|               | "0100" to "0139" | 2            |                                |
|               | "0200" to "0239" | 3            |                                |
|               | "0300" to "0339" | 4            |                                |

This command is used to store the addresses of multiple monitor values or setting data that you wish to read.

The stored monitor values or setting data can be read by sending a single "Monitor value / setting data compound store read" command. Up to 20 items can be stored, even if the addresses are not contiguous.

To specify the variable type or address, see "Appendix Setting list" (P.A-6). The upper limit of an address will vary depending on the variable type.

This command can be used in both setting area 0 and setting area 1.

Response

|      |      |               |
|------|------|---------------|
| MRC  | SRC  | Response code |
| "01" | "11" | "0000"        |

Response codes: The above indicates a normal end. For the response codes, see "6.5 Reading the variable area" (P.6-9).

## ■ Monitor value / setting data compound read store check (read)

Command

| MRC  | SRC  |
|------|------|
| "01" | "12" |

This is used to check the contents that were stored using "Monitor value / setting data compound read store".

Response

| MRC  | SRC  | Response code | Variable type | Read address |
|------|------|---------------|---------------|--------------|
| "01" | "12" | "0000"        | Type          |              |

| Variable type | Read address | Bit position |
|---------------|--------------|--------------|
| Type          |              | "00"         |

Response codes: The above indicates a normal end. For the response codes, see "6.5 Reading the variable area" (P.6-9).

## ■ Monitor value / setting data compound store read

Command

| MRC  | SRC  |
|------|------|
| "01" | "10" |

This is used to read by a single command the multiple monitor values or setting data items that were stored using "Monitor value / setting data compound read store (write)".

This command can be used in both setting area 0 and setting area 1.

If an area type error or a setting data error occurs in any of the data being read, no data will be read.

Response

| MRC  | SRC  | Response code | Variable type | Data                         |
|------|------|---------------|---------------|------------------------------|
| "01" | "10" | "0000"        | Type          | Monitor value / Setting data |

| Variable type | Data                         |
|---------------|------------------------------|
| Type          | Monitor value / Setting data |

Response codes: The above indicates a normal end. For the response codes, see "6.5 Reading the variable area" (P.6-9).

## Write via communication

| Command |      |                  |                     |
|---------|------|------------------|---------------------|
| MRC     | SRC  | Instruction code | Related information |
| "30"    | "05" | "00"             |                     |

| Related information | Description                     |
|---------------------|---------------------------------|
| "00"                | Write via communication disable |
| "01"                | Write via communication enable  |

This command is used to enable or disable "Write via communication". When sent it changes the set value of "Write via communication."

When write via communication is disabled, communication cannot be used to write setting data or send operation commands such as Run/Stop.

**The initial setting is "disabled".**

This command can be used in both setting area 0 and setting area 1.

| Response |      |               |
|----------|------|---------------|
| MRC      | SRC  | Response code |
| "30"     | "05" | "0000"        |

Response codes: The above indicates a normal end. For the response codes, see "6.7 Operation commands (Communication/CompoWay/F)" (P.6-11).

## Control Run / Control Stop

| Command |      |                  |                     |
|---------|------|------------------|---------------------|
| MRC     | SRC  | Instruction code | Related information |
| "30"    | "05" | "01"             |                     |

| Related information | Description |               |
|---------------------|-------------|---------------|
|                     | Ch          | Control state |
| "00"                | 1           | Run           |
| "01"                |             | Stop          |
| "10"                | 2           | Run           |
| "11"                |             | Stop          |
| "20"                | 3           | Run           |
| "21"                |             | Stop          |
| "30"                | 4           | Run           |
| "31"                |             | Stop          |
| "F0"                | All         | Run           |
| "F1"                |             | Stop          |

This is used to run or stop control.

This command can be used in both setting area 0 and setting area 1.

If "All" channels are selected, only those that are enabled will be affected by this command.

To use this command, "Write via communication" must be enabled using the "Write via communication" operation command.



Response

| MRC  | SRC  | Response code |
|------|------|---------------|
| "30" | "05" | "0000"        |

Response codes: The above indicates a normal end. For the response codes, see "6.7 Operation commands (Communication/CompoWay/F)" (P.6-11).

## ■ Bank change

Command

| MRC  | SRC  | Instruction code | Related information |
|------|------|------------------|---------------------|
| "30" | "05" | "02"             |                     |

| Related information | Description |                   |
|---------------------|-------------|-------------------|
|                     | Ch          | Bank No. selected |
| "00" to "07"        | 1           | 0 to 7            |
| "10" to "17"        | 2           | 0 to 7            |
| "20" to "27"        | 3           | 0 to 7            |
| "30" to "37"        | 4           | 0 to 7            |
| "F0" to "F7"        | All         | 0 to 7            |

This command is used to change banks (there are 8 banks numbered 0 to 7). An SP, alarm values, and a PID Set No. are stored in each bank.

This command can be used in both setting area 0 and setting area 1.

- An operation error will result if AT is running in the selected channel. To use this command, "Write via communication" must be enabled using the "Write via communication" operation command.

Response

| MRC  | SRC  | Response code |
|------|------|---------------|
| "30" | "05" | "0000"        |

Response codes: The above indicates a normal end. For the response codes, see "6.7 Operation commands (Communication/CompoWay/F)" (P.6-11).

## ■ AT execute

### Command

| MRC  | SRC  | Instruction code | Related information |
|------|------|------------------|---------------------|
| "30" | "05" | "03"             |                     |

| Related information | Description |  |
|---------------------|-------------|--|
|                     | Ch          | Command  |
| "00" to "08"        | 1           | 00: Currently selected PID Set No.<br>01 to 08: Specifies PID Set No. 1 to 8 |
| "10" to "18"        | 2           | 10: Currently selected PID Set No.<br>11 to 18: Specifies PID Set No. 1 to 8 |
| "20" to "28"        | 3           | 20: Currently selected PID Set No.<br>21 to 28: Specifies PID Set No. 1 to 8 |
| "30" to "38"        | 4           | 30: Currently selected PID Set No.<br>31 to 38: Specifies PID Set No. 1 to 8 |
| "F0" to "F8"        | All         | F0: Currently selected PID Set No.<br>F1 to F8: Specifies PID Set No. 1 to 8 |

This command runs AT. On the E5AR/ER, the PID Set No. must be specified when running AT.

To specify the currently selected PID Set No. (the PID set currently used for operation), set the lower byte of the related information to "0".

This command is used in setting area 0. If used in setting area 1, an operation error will result. An operation error will also result in the following situations:

- "Run/Stop" of the specified channel is set to "Stop".
- "Auto / Manual" of the specified channel is set to "Manual".

To use this command, "Write via communication" must be enabled using the "Write via communication" operation command.

### Response

| MRC  | SRC  | Response code |
|------|------|---------------|
| "30" | "05" | "0000"        |

Response codes: The above indicates a normal end. For the response codes, see "6.7 Operation commands (Communication/CompoWay/F)" (P.6-11).

## ■ AT cancel

### Command

| MRC  | SRC  | Instruction code | Related information |
|------|------|------------------|---------------------|
| "30" | "05" | "0A"             |                     |

| Related information | Description |           |
|---------------------|-------------|-----------|
|                     | Ch          | Operation |
| "00"                | 1           | Stops AT  |
| "10"                | 2           | Stops AT  |
| "20"                | 3           | Stops AT  |
| "30"                | 4           | Stops AT  |
| "F0"                | All         | Stops AT  |

This command stops AT.

This command is used in setting area 0. If used in setting area 1, an operation error will result. An operation error will also result in the following situations:

- "Run/Stop" of the specified channel is set to "Stop".
- "Auto / Manual" of the specified channel is set to "Manual".

To use this command, "Write via communication" must be enabled using the "Write via communication" operation command.

Response

| MRC  | SRC  | Response code |
|------|------|---------------|
| "30" | "05" | "0000"        |

Response codes: The above indicates a normal end. For the response codes, see "6.7 Operation commands (Communication/CompoWay/F)" (P.6-11).

## Write mode

Command

| MRC  | SRC  | Instruction code | Related information |
|------|------|------------------|---------------------|
| "30" | "05" | "04"             |                     |

| Related information | Description    |
|---------------------|----------------|
| "00"                | Backup mode    |
| "01"                | RAM write mode |

This command is used to select backup mode or RAM write mode.

The initial setting is backup mode.

This command can be used in both setting area 0 and setting area 1.

To use this command, "Write via communication" must be enabled using the "Write via communication" operation command.

| Write mode     | Explanation   |
|----------------|---|
| Backup mode    | When communication is used to write setting data of Operation, Adjustment, Adjustment 2, Bank setting, PID setting, or Approximation setting level, the data is also written to internal non-volatile memory.   |
| RAM write mode | When communication is used to write setting data of Operation, Adjustment, Adjustment 2, Bank setting, PID setting, or Approximation setting level, the data is not written to internal non-volatile memory.<br>When SP tracking or PV tracking is ON and the mode is changed to remote SP mode or manual mode, the SP is not written to internal non-volatile memory.<br>Note that when a change is made by key operation, the data is written to non-volatile memory. |

When the write mode is changed from RAM write mode to Backup mode, the setting data of Operation, Adjustment, Adjustment 2, Bank setting, PID setting, and Approximation setting levels is written to internal non-volatile memory. Each level is explained in "4.1 Setting levels and key operation" (P.4-2).

Important

The time required for RAM backup varies depending on the number of settings that were changed in RAM backup mode. The more settings that were changed, the longer the time required. For example, if all settings in Operation, Adjustment, Adjustment 2, Bank setting, PID setting, and Approximation levels were changed, the most time would be required, which is about 2 seconds.

Response

| MRC  | SRC  | Response code |
|------|------|---------------|
| "30" | "05" | "0000"        |

Response codes: The above indicates a normal end. For the response codes, see "6.7 Operation commands (Communication/CompoWay/F)" (P.6-11).

## ■ RAM data store

Command

| MRC  | SRC  | Instruction code | Related information |
|------|------|------------------|---------------------|
| "30" | "05" | "05"             | "00"                |

This writes the setting data of Operation, Adjustment, Adjustment 2, Bank setting, PID setting, and Approximation setting levels to internal non-volatile memory. For information on these levels, see "4.1 Setting levels and key operation" (P.4-2).

This command can be used in both setting area 0 and setting area 1.

To use this command, "Write via communication" must be enabled using the "Write via communication" operation command.

Response

| MRC  | SRC  | Response code |
|------|------|---------------|
| "30" | "05" | "0000"        |

Response codes: The above indicates a normal end. For the response codes, see "6.7 Operation commands (Communication/CompoWay/F)" (P.6-11).

## ■ Software reset

Command

| MRC  | SRC  | Instruction code | Related information |
|------|------|------------------|---------------------|
| "30" | "05" | "06"             | "00"                |

A software reset causes the same operation as turning the power off and on.

This command can be used in both setting area 0 and setting area 1.

To use this command, "Write via communication" must be enabled using the "Write via communication" operation command.

Response

**(No response)**

A response is not returned to this operation command.

## ■ Move to setting area 1

### Command

| MRC  | SRC  | Instruction code | Related information |
|------|------|------------------|---------------------|
| "30" | "05" | "07"             | "00"                |

Use this command to move to setting area 1.

The command is used in setting area 0. Nothing happens if the command is used in setting area 1.

If the command is used when "Initial setting protect" is set to "2 (Disable move to input initial setting level)", an operation error will result.

To use this command, "Write via communication" must be enabled using the "Write via communication" operation command.

### Response

| MRC  | SRC  | Response code |
|------|------|---------------|
| "30" | "05" | "0000"        |

Response codes: The above indicates a normal end. For the response codes, see "6.7 Operation commands (Communication/CompoWay/F)" (P.6-11).

## ■ Move to protect level

### Command

| MRC  | SRC  | Instruction code | Related information |
|------|------|------------------|---------------------|
| "30" | "05" | "08"             | "00"                |

Use this command to move to protect level. Protect level is explained in "5.5 Protecting settings" (P.5-24).

This command is used in setting area 0. If used in setting area 1, an operation error will result.

To use this command, "Write via communication" must be enabled using the "Write via communication" operation command.

### Response

| MRC  | SRC  | Response code |
|------|------|---------------|
| "30" | "05" | "0000"        |

Response codes: The above indicates a normal end. For the response codes, see "6.7 Operation commands (Communication/CompoWay/F)" (P.6-11).

## ■ Auto / Manual

### Command

| MRC  | SRC  | Instruction code | Related information |
|------|------|------------------|---------------------|
| "30" | "05" | "09"             |                     |

| Related information | Description |                |
|---------------------|-------------|----------------|
|                     | Ch          | Operation mode |
| "00"                | 1           | Auto           |
| "01"                |             | Manual         |
| "10"                | 2           | Auto           |
| "11"                |             | Manual         |
| "20"                | 3           | Auto           |
| "21"                |             | Manual         |
| "30"                | 4           | Auto           |
| "31"                |             | Manual         |
| "F0"                | All         | Auto           |
| "F1"                |             | Manual         |

Use this command to select auto or manual operation.

This command is used in setting area 0.

To use this command, "Write via communication" must be enabled using the "Write via communication" operation command.

### Response

| MRC  | SRC  | Response code |
|------|------|---------------|
| "30" | "05" | "0000"        |

Response codes: The above indicates a normal end. For the response codes, see "6.7 Operation commands (Communication/CompoWay/F)" (P.6-11).

## ■ Initialize settings

### Command

| MRC  | SRC  | Instruction code | Related information |
|------|------|------------------|---------------------|
| "30" | "05" | "0B"             | "00"                |

This returns all settings to the initial settings.

This command is used in setting area 1. If used in setting area 0, an operation error will result.

To use this command, "Write via communication" must be enabled using the "Write via communication" operation command.

### Response

| MRC  | SRC  | Response code |
|------|------|---------------|
| "30" | "05" | "0000"        |

Response codes: The above indicates a normal end. For the response codes, see "6.7 Operation commands (Communication/CompoWay/F)" (P.6-11).

## ■ Cancel latch

### Command

| MRC  | SRC  | Instruction code | Related information |
|------|------|------------------|---------------------|
| "30" | "05" | "0C"             |                     |

| Related information | Description |                    |
|---------------------|-------------|--------------------|
|                     | Ch          | Command            |
| "00"                | 1           | Cancel alarm latch |
| "10"                | 2           | Cancel alarm latch |
| "20"                | 3           | Cancel alarm latch |
| "30"                | 4           | Cancel alarm latch |
| "F0"                | All         | Cancel alarm latch |

This command cancels alarm latch. The command is used when the alarm latch function is in use.

This command can be used in both setting area 0 and setting area 1.

If AT is being run in the specified channel, an operation error will result.

- To use this command, "Write via communication" must be enabled using the "Write via communication" operation command.

### Response

| MRC  | SRC  | Response code |
|------|------|---------------|
| "30" | "05" | "0000"        |

Response codes: The above indicates a normal end. For the response codes, see "6.7 Operation commands (Communication/CompoWay/F)" (P.6-11).

## ■ SP mode

### Command

| MRC  | SRC  | Instruction code | Related information |
|------|------|------------------|---------------------|
| "30" | "05" | "0D"             |                     |

| Related information | Description |                               |
|---------------------|-------------|-------------------------------|
|                     | Ch          | Command                       |
| "00"                | 1           | Local SP                      |
| "01"                |             | Remote SP                     |
| "10"                | 2           | Local SP<br>(Cascade open)    |
| "11"                |             | Remote SP<br>(Cascade closed) |

Use this command to select the SP mode (Local SP / Remote SP). The command can be used when cascade control or remote SP is in use.

This command can be used in both setting area 0 and setting area 1.

- If AT is being run in the specified channel, an operation error will result.

To use this command, "Write via communication" must be enabled using the "Write via communication" operation command.

|          |      |      |               |
|----------|------|------|---------------|
| Response | MRC  | SRC  | Response code |
|          | "30" | "05" | "0000"        |

Response codes: The above indicates a normal end. For the response codes, see "6.7 Operation commands (Communication/CompoWay/F)" (P.6-11).

## ■ Read machine attributes

|         |      |      |
|---------|------|------|
| Command | MRC  | SRC  |
|         | "05" | "03" |

This command reads the E5AR/ER model and communication buffer size.

The command can be used in any state of the E5AR/ER.

|          |      |      |               |        |             |
|----------|------|------|---------------|--------|-------------|
| Response | MRC  | SRC  | Response code | Format | Buffer size |
|          | "05" | "03" | "0000"        |        | "00D9"      |

Response codes: The above indicates a normal end. For the response codes, see "6.7 Operation commands (Communication/CompoWay/F)" (P.6-11).

### Model

|   |   |   |   |   |   |   |   |   |   |
|---|---|---|---|---|---|---|---|---|---|
| 0 | 1 | 2 | 3 | 4 | 5 | 6 | 7 | 8 | 9 |
| E | 5 | ① | R | - | ② | ③ |   |   |   |

\*Bytes 7 to 9 are blank

#### ① Size

| Symbol | Size                |
|--------|---------------------|
| A      | A size (96 × 96 mm) |
| E      | E size (96 × 48 mm) |

#### ② Constant / program

| Symbol  | Constant / program |
|---------|--------------------|
| (Blank) | Constant           |

#### ③ Standard / Position proportional

| Symbol  | Standard / position proportional |
|---------|----------------------------------|
| (Blank) | Standard                         |
| P       | Position proportional            |



## ■ Controller status read (Communication/CompoWay/F)

Command

|      |      |
|------|------|
| MRC  | SRC  |
| "06" | "01" |

This command reads the operation status of the E5AR/ER.

The command can be used in any state of the E5AR/ER.

Response

|      |      |               |                 |                     |
|------|------|---------------|-----------------|---------------------|
| MRC  | SRC  | Response code | Operation state | Related information |
| "06" | "01" | "0000"        |                 |                     |

Response codes: The above indicates a normal end. For the response codes, see "6.7 Operation commands (Communication/CompoWay/F)" (P.6-11).

### ◆ Operation state

|     |   |     |   |     |   |     |   |              |
|-----|---|-----|---|-----|---|-----|---|--------------|
| 7   | 6 | 5   | 4 | 3   | 2 | 1   | 0 | Bit position |
| 0   | 0 | 0   | 0 |     |   |     |   |              |
| ch4 |   | ch3 |   | ch2 |   | ch1 |   |              |

| Bit position | Operation state                       |
|--------------|---------------------------------------|
| 00           | Operating                             |
| 01           | Error<br>(MV at PV error output)      |
| 10           | Stopped<br>(Including setting area 1) |
| 11           | Manual mode                           |

The operation state of each channel is indicated using a 2-bit code.

### ◆ Related information

|   |   |   |   |   |   |   |   |              |
|---|---|---|---|---|---|---|---|--------------|
| 7 | 6 | 5 | 4 | 3 | 2 | 1 | 0 | Bit position |
|   |   |   |   |   |   |   |   |              |

| Bit position | Status                | Bit description |          |
|--------------|-----------------------|-----------------|----------|
|              |                       | 0               | 1        |
| 0            | Blank                 | –               | –        |
| 1            | Blank                 | –               | –        |
| 2            | CT input error        | Not occurred    | Occurred |
| 3            | RSP input error       | Not occurred    | Occurred |
| 4            | Potentiometer error   | Not occurred    | Occurred |
| 5            | Exceeds display range | Not occurred    | Occurred |
| 6            | Input error           | Not occurred    | Occurred |
| 7            | Blank                 | –               | –        |

\* OR of channels set in "Number of enabled channels".

\* When the channel does not exist, is "Not occurred: 0".

\* If this command is used in setting area 1, the related information is undefined.

## ■ Echo back test

### Command

| MRC  | SRC  | Test data      |
|------|------|----------------|
| "08" | "01" | 0 to 200 bytes |

This command is used to perform an echo back test.

The command can be used in any state of the E5AR/ER.

Keep the test data within the following ranges depending on the communication data length.

| Communication data length | Description                             |
|---------------------------|---|
| 7 bits                    | ASCII code H'20 to H'7E                 |
| 8 bits                    | ASCII code H'20 to H'7E or H'A1 to H'FE |

### Response

| MRC  | SRC  | Response code | Test data     |
|------|------|---------------|---------------|
| "08" | "01" | "0000"        | 0 ~ 200 bytes |

Response codes: The above indicates a normal end. For the response codes, see "6.7 Operation commands (Communication/CompoWay/F)" (P.6-11).

## 6.10 Program example

### ■ N88Basic

This program displays the response from the E5AR/ER on the screen when command data is entered from the keyboard.

Command data from the unit number to the number of elements must be entered.

The program was created in N88BASIC.

```

1000 '-----
1010 'PROGRAM: E5AR/ER Communication Sample Program(CompoWay/F)
1020 'VERSION:1.00
1030 '(c)Copyright OMRON Corporation 2003
1040 'All Rights Reserved
1050 '-----
1060 '
1070 '=====Communication port (PARITY=EVEN, DATA=7, STOP=2) =====
1080 '
1090 OPEN "COM:E73" AS #1
1100 '
1110 *SENDDATA
1120 '
1130 ===== Communication routine=====
1140 '
1150 -----Communication data input-----
1160 INPUT "SEND DATA:",SEND$
1170 '
1180 -----If no input, jump to end routine-----
1190 IF SEND$ = " " THEN *EXITSEND
1200 '
1210 -----BCC calculation-----
1220 BCC = 0
1230 SEND$ = SEND$+CHR$(3)
1240 FOR I=1 TO LEN(SEND$)
1250   BCC = BCC XOR ASC(MID$(SEND$, I, 1))
1260 NEXT I
1270 BCC$ = CHR$(BCC)
1280 '
1290 -----Send-----
1300 SDATA$ = CHR$(2)+SEND$+BCC$
1310 PRINT #1, SDATA$;
1320 '
1330 ===== Receive routine =====
1340 '
1350 RDATA$ = " "
1360 TIMEOUT = 0
1370 *RCVLOOP
1380 -----No response detection-----
1390 TIMEOUT = TIMEOUT+1
1400 IF TIMEOUT > 2000 THEN RESP$ = "No Response":GOTO *RCVEND
1410 IF LOC(1) = 0 THEN *RCVLOOP
1420 '
1430 -----Check for end character (if no end character, continue reading)
1440 RDATA$ = RDATA$+INPUT$(LOC(1),#1)
1450 IF LEN(RDATA$) < 2 THEN *RCVLOOP
1460 IF MID$(RDATA$,LEN(RDATA$)-1,1) <> CHR$(3) THEN *RCVLOOP
1470 RESP$ = MID$(RDATA$,2,LEN(RDATA$)-2)
1480 *RCVEND
1490 '
1500 -----Display received data-----
1510 PRINT "RESPONSE:;",RESP$
1520 GOTO *SENDDATA
1530 '
1540 *EXITSEND
1550 =====End routine=====
1560 CLOSE #1
1570 END

```

● **Operation example**    Reading the present value of Unit No.01.

```
RUN
SEND DATA:010000101C00000000001
RESPONSE:010000010100000000014F
```

SEND DATA: [STX] 01 00 0 0101 C0 0000 00 0001 [ETX] [BCC]



RESPONSE: [STX] 01 00 00 0101 0000 0000014F [ETX] [BCC]

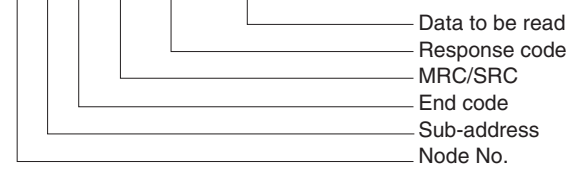



# Section 7 Communication (Modbus)

|     |   |      |
|-----|---|------|
| 7.1 | Communication method.....                         | 7-2  |
| 7.2 | Frames.....                                       | 7-4  |
| 7.3 | List of functions.....                            | 7-7  |
| 7.4 | Variable area.....                                | 7-8  |
| 7.5 | Reading the variable area.....                    | 7-10 |
| 7.6 | Writing to the variable area.....                 | 7-12 |
| 7.7 | Operation commands (Communication/Modbus) .....   | 7-14 |
| 7.8 | Setting areas .....                               | 7-16 |
| 7.9 | Commands and responses (Communication/Modbus).... | 7-17 |

## 7.1 Communication method

### ■ Modbus communication protocol

#### Supplement

The communication function is used by creating a program on the host computer. As such, the explanations in this section are from the perspective of the host computer.

For example, "Read/Write" refers to the host computer reading or writing to the E5AR/ER.

This communication method is based on RTU Mode of the Modbus Protocol of Modicon Inc. (Specifications: PI-MBUS-300 Rev.J) Detailed specifications for the Modbus protocol are shown below.

### ■ Communication specifications

|                         |  |
|-------------------------|--|
| Transfer connection:    | Multi-point  |
| Communication method:   | RS-485 (2-wire half duplex)  |
| Synchronization method: | Start-stop   |
| Communication speed:    | 9.6 k/19.2 k/38.4 k bit/s  |
| Send code:              | RTU (Remote Terminal Unit)   |
| Data length:            | 8 bits   |
| Stop bit length:        | Automatically set by vertical parity setting                                 |
| Error detection:        | Vertical parity None/ <b>Even</b> /Odd<br>CRC-16 (Cyclical Redundancy Check) |
| Flow control:           | None   |
| Interface:              | RS-485   |
| Retry function:         | None   |

\* Initial settings are shaded.

### ■ Transfer protocol (Communication/Modbus)

The host computer sends a command frame, and the E5AR/ER sends a response frame based on the content of the command frame. One response frame is sent in response to one command frame.

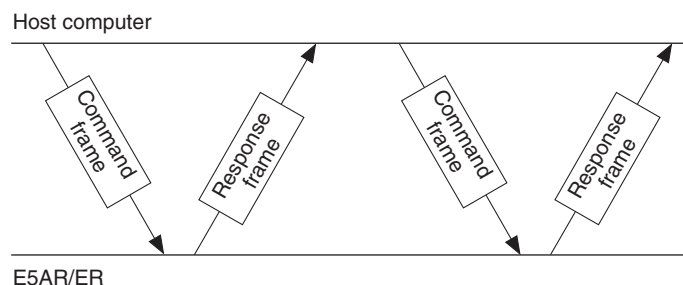

The exchange between the command frame and response frame is explained below.

After receiving a response from the controller, the host computer waits at least 5 ms before sending the next command.

When writing multiple sets of setting data in a row, such as when writing to the variable area or performing a compound write, controllability may be affected. Pay attention to the following points:

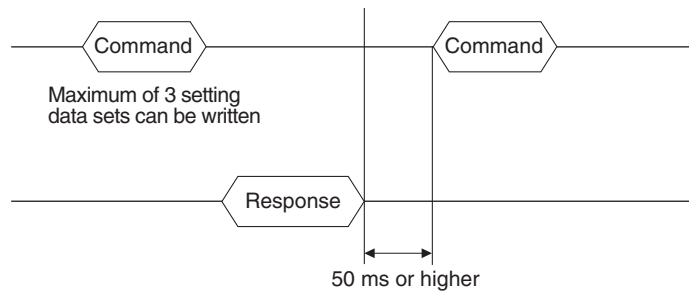



## 7.2 Frames

Based on the Modbus (RTU) communication protocol, commands from the host computer and responses from the E5AR/ER take the form of **frames**.

The data comprising command frames and response frames are explained below.

In the following explanation, an "H" at the beginning of a numeric value (for example H'02) indicates that the value is a hexadecimal number. A number or letters enclosed in quotation marks (for example "00") is an ASCII character.

### ■ Command frame

In RTU mode each frame begins and ends with a silent time interval that is at least 3.5 characters long.

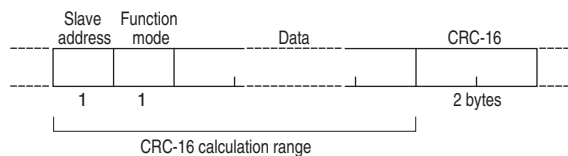

|                |   |
|----------------|---|
|                | Silent interval at least 3.5 characters long.   |
| Client address | Specify the "Unit No." of the E5AR/ER. Set in hexadecimal from H'00 to H'63 (0 to 99). When broadcasting to all units, specify H'00. Responses are not returned to a broadcast.       |
| Function code  | The function code indicates the type of command from the host computer. The code is set in hexadecimal and is 1 byte long. For more information, see "7.3 List of functions" (P.7-7). |
| Data           | Text of command based on the function code. Specifies variable addresses and the values of setting data (specify in hexadecimal).   |
| CRC-16         | Cyclical Redundancy Check. This is a check code calculated from the client address to the end of the data. Two bytes in hexadecimal.  |
|                | Silent interval at least 3.5 characters long.   |

### ● Example of CRC-16 calculation

#### Supplement

CRC-16 calculation method:  
As indicated at right, the value from the client address to the end of the data is calculated and the result set in CRC-16.

The following explains how a message is processed 1 byte at a time in the processing register (this is a 16-bit register called the "CRC register").

- (1) Set an initial value of H'FFFF in the CRC register.
- (2) Perform XOR on the CRC register and the 1st byte of the message, and return the result to the CRC register.
- (3) Shift the contents of the CRC register 1 bit to the right, filling the MSB with "0".
- (4) If the bit shifted from the LSB is "0", repeat step (3).  
If the bit shifted from the LSB is "1", perform XOR on the CRC register and H'A001, and return the result to the CRC register.
- (5) Repeat steps (3) and (4) until the contents of the register have been shifted 8 bits to the right.

(6) If the end of the message has not been reached, perform XOR on the next byte of the CRC register and the message, return the result to the CRC register, and repeat the procedure from step (3).

(7) Append the result (the value in the CRC register) to the lower byte of the message.

Example of appending the result

If the calculated CRC value is H'1234, this is appended as follows to the command frame.

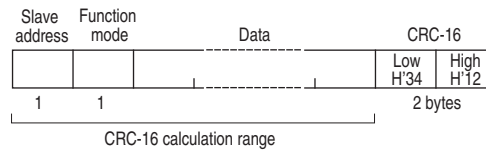

## ■ Response frame

### ● Normal response frame

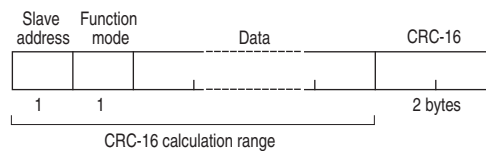

### ● Error response frame

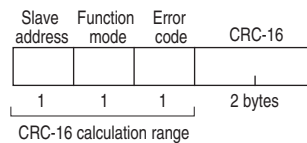

|                |  |
|----------------|--|
| Client address | The number that was specified in the command frame appears here. This is the unit number of the responding E5AR/ER.  |
| Function code  | The function code that was received.<br>In an error response frame, "H'80" is added to the value to indicate that this is an error response.<br>Example: Received function code = H'03<br>Function code in error response frame = H'83 |
| Error code     | End code that indicates the error.   |
| CRC-16         | Cyclical Redundancy Check. This is a check code calculated from the client address to the end of the data. Two bytes in hexadecimal.   |

**Error codes (Communication/Modbus)**

| End code | Name                   | Description   | Error detection priority |
|----------|------------------------|---|--------------------------|
| H'01     | Function code error    | Received an unused function code.   | 1                        |
| H'02     | Variable address error | The variable area number specified in the variable address is out of range.   | 2                        |
| H'03     | Variable data error    | The number of elements does not agree with the number of data items.<br>Number of elements $\times$ 2 does not agree with the byte count.<br>The response length exceeds the communication buffer size.<br>The operation code or related information in an operation command is not correct.<br>The written data exceeds the setting range.   | 3                        |
| H'04     | Operation error        | The setting information in the written data is not permitted in the current operation mode.<br><ul style="list-style-type: none"> <li>◆ "Write via communication" is OFF (disabled).</li> <li>◆ Attempted to write to setting data of setting area 1 from setting area 0.</li> <li>◆ Attempted to write to protect setting data from other than protect level.</li> <li>◆ AT is running.</li> <li>◆ User calibration in progress.</li> <li>◆ Cannot process the operation command.</li> <li>◆ Unit error, unit change, display unit error, internal non-volatile memory error.</li> </ul> | 4                        |

**● No response**

In the following cases, the received command is not processed and a response is not returned. For this reason, a time-out occurs at the host device.

- The client address in the received command is different from the communication unit number set in the E5AR/ER.
- A parity error, framing error, or overrun error occurred due to a transfer or other error.
- A CRC-16 code error occurred in the received command frame.
- An time interval greater than 3.5 characters occurred between data sets while receiving the command frame.

## 7.3 List of functions

Function codes supported on the E5AR/ER are shown below.

### Function codes (Communication/Modbus)

| Function codes | Name                               | Description   |
|----------------|------------------------------------|---|
| 03 (H'03)      | Read variables (multiple)          | Reads the variable area. Multiple variables that are contiguous can be read.                                |
| 16 (H'10)      | Write variables (multiple)         | Writes to the variable area. Can write to multiple variables that are contiguous. Broadcasting is possible. |
| 06 (H'06)      | Write variable (operation command) | Writes an operation command. Broadcasting is possible.  |
| 08 (H'08)      | Echo back test                     | Performs an echo back test.   |

## 7.4 Variable area

The area used for data exchange when communicating with the E5AR/ER is called the "**variable area**". The PV is read and various setting data are read and written using the variable area of the E5AR/ER. Operation commands do not use the variable area.

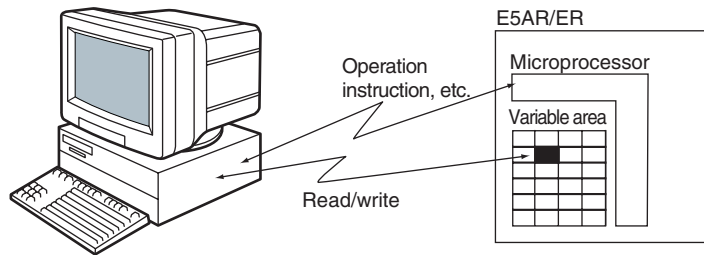

The variable area is accessed by specifying the position of a **variable** within the variable area using a channel identifier, area number, and in-area **address**.

### ● Address (Communication/Modbus)

Each variable type has an address. Each address is two bytes long and expressed in hexadecimal. Assign addresses according to units of access size. An address consists of a channel identifier, area number, and in-area address.

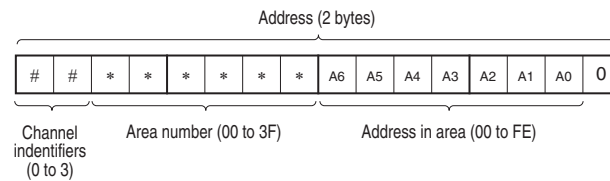

### Area numbers

Area numbers in the variable area are as follows:

| Variable type | Description                     | Area                                      |
|---------------|---------------------------------|---|
| 04            | Communication monitor           | Setting area 0<br>(Operation in progress) |
| 05            | Protect level                   |   |
| 06            | RUN level                       |   |
| 07            | Adjustment level                |   |
| 08            | Adjustment level 2              |   |
| 09            | Bank setting level              |   |
| 0A            | PID setting level               |   |
| 0B            | Approximation setting level     |   |
| 0C            | Input initial setting level     | Setting area 1<br>(Operation stopped)     |
| 0D            | Control initial setting level   |   |
| 0E            | Control initial setting 2 level |   |
| 0F            | Alarm setting level             |   |
| 10            | Display adjustment level        |   |
| 11            | Communications setting level    |   |
| 12            | Special function setting level  |   |
| 13            | Expansion control setting level |   |

### Channel identifier

For multi-point input types that require settings for channels 2 to 4, specify 1 to 3 to identify the channels.

On single-input types, only "0: Channel 1" can be specified.

| Channel identifier | Channel   |
|--------------------|-----------|
| 0                  | Channel 1 |
| 1                  | Channel 2 |
| 2                  | Channel 3 |
| 3                  | Channel 4 |

### In-area address

This is a number that is assigned to each set of data in the variable area. Addresses are assigned in order beginning from the first set.

For more information on addresses, see the Modbus section in "Appendix Setting list" (P.A-6). Note that the addresses indicated in the variable area map are addresses of channel 1.

For example, to specify an address of channel 2 on a multi-point input type, add H'4000 to the address in the variable area map. For channel 3 add H'8000, and for channel 4 add H'C000.

## ● Number of elements

The number of elements is expressed as a 2-byte hexadecimal value. The specification range for the number of elements varies depending on the command. See "7.9 Commands and responses (Communication/Modbus)" (P.7-17).

For example, if the number of elements is 0010, the first 8 elements of data (H'10) from the address are specified.

In Modbus protocol one element is two bytes of data, however, setting data on the E5AR/ER is four bytes.

## ● Set values

Values read and written to the variable area are expressed in hexadecimal and disregard the decimal point position (negative values are expressed as a two's complement).

Example: D'105.0 → H'0000041A

The variable is an 8-digit number in hexadecimal. Negative values are expressed as a two's complement. The decimal is disregarded.

For example, if the PV of the E5AR/ER is 105.0, it will be read as H'0000041A (105.0 → 1050 → H'0000041A).

Use of the variable area on the E5AR/ER is explained in the following sections.

## 7.5 Reading the variable area

The variable area is read by setting the required data in the following command frame.

Command

### Command frame

| Slave address | Function mode | Read start address | Number of elements | CRC-16  |
|---------------|---------------|--------------------|--------------------|---------|
| 1             | H'03          | 2                  | 2                  | 2 bytes |

| Data name             | Explanation   |
|-----------------------|---|
| Client address        | Specify the "Unit No." of the E5AR/ER. Set in hexadecimal from H'01 to H'63 (1 to 99).  |
| Function code         | The function code for variable area read is H'03.   |
| First address of read | Specify the address of the setting data that you wish to read.<br>For more information on addresses, see "Appendix Setting list" (P.A-6).   |
| Number of elements    | Specify the number of setting data items that you wish to read $\times 2$ for the number of elements. The setting range is H'0002 to H'006A (2 to 106).<br>Example: If the number of setting data sets is 2, specify H' 0004. |
| CRC-16                | Check code calculated based on the value from the client address to the data end. For the calculation method, see "7.2 Frames ■ Command frame ● Example of CRC-16 calculation" (P.7-4).                                       |

Response

### Response frame

| Slave address | Function mode | Byte count | Read data                           |                   | CRC-16 |
|---------------|---------------|------------|-------------------------------------|-------------------|--------|
|               |               |            | Data 1                              | Data 1            |        |
| 1             | H'03          | 1          | Most significant                    | Least significant | 2      |
|               |               |            | Number of elements $\times 2$ bytes |                   |        |
|               |               |            | Data n                              | Data n            |        |
|               |               |            | Most significant                    | Least significant |        |

| Data name      | Explanation  |
|----------------|--|
| Client address | The value from the command frame appears here.   |
| Function code  | This is the received function code.<br>In an error response frame, "H'80" is added to the received function code to indicate that it is an error response.<br>Example: Received function code = H'03<br>Function code in error response frame = H'83 |
| Byte count     | Number of bytes of data that were read.  |
| Read data      | The setting data that was read.  |
| CRC-16         | This is a check code calculated from the client address to the data end. For the calculation method, see "7.2 Frames ■ Command frame ● Example of CRC-16 calculation" (P.7-4).   |

### Response codes

| Function code | Error code | Error name             | Cause   |
|---------------|------------|------------------------|---|
| H'83          | H'02       | Variable address error | Error in leading address of read.   |
|               | H'03       | Variable data error    | The number of elements exceeds the specified range.   |
|               | H'04       | Operation error        | Unit error, unit change, display unit error, EEP error (does not occur when number of elements is 0). |
| H'03          | –          | Normal end             | No error.   |

◆ Reading non-display data

Setting data can be read even if it is set to non-display or is not displayed due to the model.

#### Command response example

Reading the PV of channel 1

(Client address: H'01)

PV of channel 1 (set as read-only data)

Address : H'0404

Data read : H'000003E8 (100.0°C)

Command: 01 03 0404 00 02 (CRC-16)

Response: 01 03 04 00 00 03 E8 (CRC-16)



## 7.6 Writing to the variable area

Write to the variable area by setting the required data in the following command frame.

Command

### Command frame

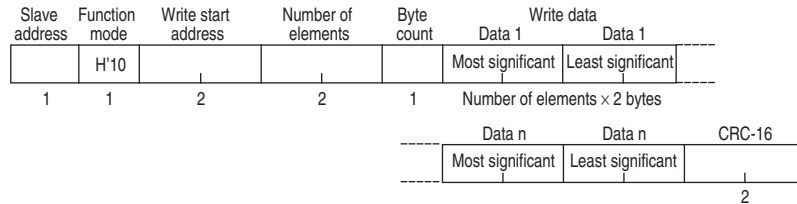

| Data name              | Explanation  |
|------------------------|--|
| Client address         | Specify the "Unit No." of the E5AR/ER. Set in hexadecimal from H'01 to H'63 (1 to 99).   |
| Function mode          | The function code for variable area write is H' 10.  |
| First address of write | Specify the address of the setting data to which you wish to write.<br>For more information on addresses, see "Appendix Setting list" (P.A-6).   |
| Number of elements     | Specify the number of setting data items that you wish to write × 2 for the number of elements. The setting range is H'0002 to H'0068 (2 to 104).<br>Example: When the number of setting data items is 2, specify H' 0004. |
| Byte count             | Specify the number of bytes of data to be written.   |

Response

### FINS-mini response text

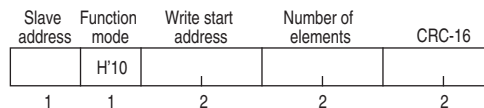

| Data name                  | Explanation  |
|----------------------------|--|
| Client address             | The value from the command frame appears here.   |
| Function mode              | This is the received function code.<br>In an error response frame, "H'80" is added to the received function code to indicate that it is an error response.<br>Example: Received function code = H'10<br>Function code in error response frame = H'90 |
| Beginning address of write | Beginning address of write that was received.  |
| Number of elements         | Received number of elements.   |
| CRC-16                     | This is a check code calculated from the client address to the data end. For the calculation method, see "7.2 Frames ■ Command frame ● Example of CRC-16 calculation" (P.7-4).   |

## Response codes

| Function code | Error code | Error name             | Cause  |
|---------------|------------|------------------------|--|
| H'90          | H'02       | Variable address error | Error in leading variable address of write   |
|               | H'03       | Variable data error    | <ul style="list-style-type: none"> <li>◆ Number of elements and number of data items do not agree.</li> <li>◆ Number of elements × 2 does not agree with byte count.</li> <li>◆ Write data exceeds the setting range.</li> </ul>   |
|               | H'04       | Operation error        | <p>The operation state does not permit writing. The settings for the write data are not permitted in the current operation mode.</p> <ul style="list-style-type: none"> <li>◆ Write via communication is OFF (disabled).</li> <li>◆ Attempted to write to setting data of setting area 1 from setting area 0.</li> <li>◆ Attempted to write to protect setting data from other than protect level.</li> <li>◆ AT is running.</li> <li>◆ User calibration in progress.</li> </ul> <p>Unit error, unit change, display unit error, non-volatile memory error</p> |
| H'10          | –          | Normal end             | No error   |

## ◆ Writing non-display data

It is possible to write to setting data even if it is set to non-display or is not displayed due to the model; however, exercise caution when writing continuously.

**Command/response example**

Writing to "SP setting upper limit" and "SP setting lower limit" of control initial setting level of channel 1. (Client address: H'01)

SP setting upper limit of channel 1

Address : H'0D1E

Data written : H'00002710 (1000.0°C)

SP setting lower limit of channel 1

Address : H'0D20

Data written : H'FFFFFFC18 (-100.0°C)

Command: 01 10 0D1E 0004 08 00 00 27 10 FF FF FC 18 (CRC-16)

Response: 01 10 0D1E 0004 (CRC-16)

## 7.7 Operation commands (Communication/Modbus)

Operation commands are sent using the following command frame.

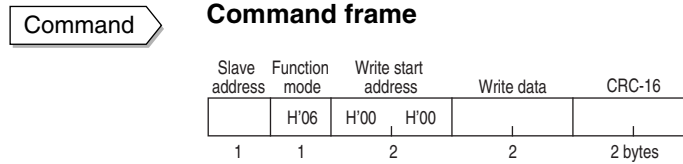

| Data name                  | Explanation  |
|----------------------------|--|
| Client address             | Specify the "Unit No." of the E5AR/ER. Set in hexadecimal from H'01 to H'63 (1 to 99).   |
| Function mode              | The function code for an operation command is H' 06.   |
| Beginning address of write | Specify H' 0000 for the operation command address.   |
| Data written               | Enter the command code of the operation command and related information (see table below).   |
| CRC-16                     | This is a check code calculated from the client address to the data end. For the calculation method, see "7.2 Frames ■ Command frame ● Example of CRC-16 calculation" (P.7-4). |

Operation commands for the E5AR/ER are shown in the following.

| Operation code | Description             | Related information |  |
|----------------|-------------------------|---------------------|--|
|                |                         | Upper Byte          | Lower Byte   |
| H'00           | Write via communication | H'0 *1              | H'0: OFF (Disabled)<br>H'1: ON (Enabled)                     |
| H'01           | Run/Stop                | H'0 to 3, F *2      | H'0: Run H'1: Stop   |
| H'02           | Bank change             | H'0 to 3, F *2      | H'0 to 7: Bank 0 to 7  |
| H'03           | AT run                  | H'0 to 3, F *2      | H'0: Currently selected PID Set No.<br>H'1 to 8: PID Set No. |
| H'04           | Write mode              | H'0 *1              | H'0: Backup mode<br>H'1: RAM write mode                      |
| H'05           | RAM data save           | H'0 *1              | H'0  |
| H'06           | Software reset          | H'0 *1              | H'0  |
| H'07           | Move to setting area 1  | H'0 *1              | H'0  |
| H'08           | Move to protect level   | H'0 *1              | H'0  |
| H'09           | Auto/Manual             | H'0 to 3, F *2      | H'0: Auto mode<br>H'1: Manual mode                           |
| H'0A           | AT stop                 | H'0 to 3, F *2      | H'0: Stop  |
| H'0B           | Initialize settings     | H'0 *1              | H'0  |
| H'0C           | Cancel latch            | H'0 to 3, F *2      | H'0  |
| H'0D           | SP mode                 | H'0 to 3, F *2      | H'0: LSP H'1: RSP  |

\*1: Operates for all channels.

\*2: Specify for each channel

0: CH1, 1: CH2, 2: CH3, 3: CH4, F: All channels

\*: There is no response to a software reset.

\*: When all channels are specified, only enabled channels will respond and processing will begin from Channel 1. If an error is detected on any one channel, an "Operation error" will result. If all channels end normally, "Normal end" results.

Response

Response frame

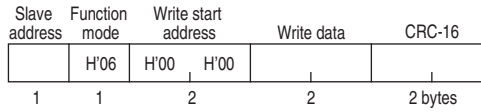

| Data name                  | Explanation  |
|----------------------------|--|
| Client address             | The value from the command frame appears here.   |
| Function code              | This is the received function code.<br>In an error response frame, "H'80" is added to the received function code to indicate that it is an error response.<br>Example: Received function code = H'06<br>Function code in error response frame = H'86 |
| Beginning address of write | Beginning address of write that was received.  |
| Written data               | Received operation command data.   |
| CRC-16                     | This is a check code calculated from the client address to the data end. For the calculation method, see "7.2 Frames ■ Command frame ● Example of CRC-16 calculation" (P.7-4).   |

Response codes

| Function code | Error code | Error name             | Cause   |
|---------------|------------|------------------------|---|
| H'86          | H'02       | Variable address error | The variable address is not H'0000.   |
|               | H'03       | Variable data error    | Error in written data.<br>• Incorrect command code or related information.  |
|               | H'04       | Operation error        | The operation state does not permit writing.<br>• Write via communication is OFF (disabled). Note that the command is received regardless of write via communication ON/OFF.<br>• Cannot process.<br>See explanation of commands in "7.9 Commands and responses (Communication/Modbus)" (P.7-17).<br>Unit error, unit change, display unit error, non-volatile memory error |
| H'06          | –          | Normal end             | No error  |

Command/response example

Operation command to channel 2 (client address: H'01)

Channel 2 operation command

Address : H'0000

Written data: H'0111 (Stop command to channel 2)

Command: 01 06 00 00 01 11 (CRC-16)

Response: 01 06 00 00 01 11 (CRC-16)

## 7.8 Setting areas

The E5AR/ER has two setting areas for communication functions: **Setting area 0 and setting area 1.**

In setting area 0, control continues.

As such, setting area 0 makes it possible to perform operations that require control to be in progress, such as reading the PV, writing an SP, and run/stop, as well as operations that do not interfere with control. On the other hand, operations that may change control such as writing initial setting data cannot be performed. (Note that setting data that cannot be written can still be read.)

In setting area 1, control is stopped.

This makes it possible to perform operations such as writing initial setting data which are not possible in setting area 0.

When the power is turned on, setting area 0 is selected. To access setting area 1, use the "Move to setting area 1" operation command. To return to setting area 0 from setting area 1, turn off the power or use the "Software reset" operation command.

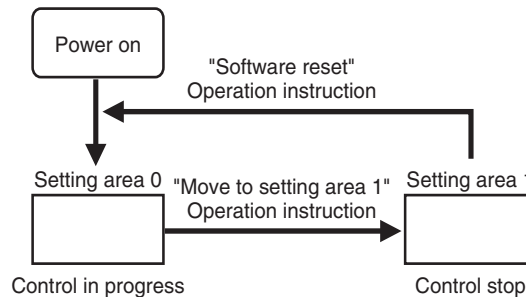

| Description                     | Area                               |
|---------------------------------|------------------------------------|
| Communication monitor           | Setting area 0<br>(During control) |
| Protect level                   |                                    |
| RUN level                       |                                    |
| Adjustment level                |                                    |
| Adjustment level 2              |                                    |
| Bank setting level              |                                    |
| PID setting level               |                                    |
| Approximation setting level     |                                    |
| Input initial setting level     | Setting area 1<br>(Control stop)   |
| Control initial setting level   |                                    |
| Control initial setting 2 level |                                    |
| Alarm setting level             |                                    |
| Display adjustment level        |                                    |
| Communications setting level    |                                    |
| Special function setting level  |                                    |
| Expansion control setting level |                                    |

## 7.9 Commands and responses (Communication/Modbus)

The E5AR/ER provides a set of command frames that make use of variable area read/write commands, operation commands, and other services provided by the Modbus communication protocol.

E5AR/ER command frames are explained below.

### ■ Monitor value read (Communication/Modbus)

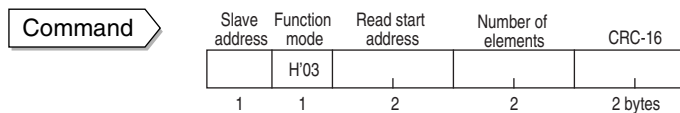

| Address | Monitor value |                     | Address | Monitor value |                     |
|---------|---------------|---------------------|---------|---------------|---------------------|
|         | Ch            | Data name           |         | Ch            | Data name           |
| H'0400  | 1             | Version             | H'8400  | 3             | Version             |
| H'0402  |               | Modification type   | H'8402  |               | Modification type   |
| H'0404  |               | PV                  | H'8404  |               | PV                  |
| H'0406  |               | Internal SP         | H'8406  |               | Internal SP         |
| H'0408  |               | Bank No. monitor    | H'8408  |               | Bank No. monitor    |
| H'040A  |               | PID Set No. monitor | H'840A  |               | PID Set No. monitor |
| H'040C  |               | Status              | H'840C  |               | Status              |
| H'4400  | 2             | Version             | H'C400  | 4             | Version             |
| H'4402  |               | Modification type   | H'C402  |               | Modification type   |
| H'4404  |               | PV                  | H'C404  |               | PV                  |
| H'4406  |               | Internal SP         | H'C406  |               | Internal SP         |
| H'4408  |               | Bank No. monitor    | H'C408  |               | Bank No. monitor    |
| H'440A  |               | PID Set No. monitor | H'C40A  |               | PID Set No. monitor |
| H'440C  |               | Status              | H'C40C  |               | Status              |

This command is used to read the PV, status, and other monitor values. The number of elements can be set from H'0004 to 006A (4 to 106) to allow reading of monitor values in contiguous addresses.

When used in setting area 1, the response for the PV and internal SP is "0" and the response for the status is as indicated in the notes in "Appendix Setting list Status" (P.A-8).

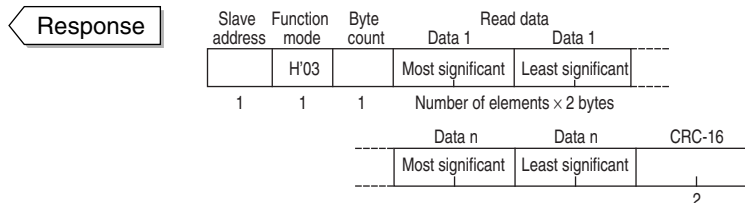

The above indicates a normal end. For information on error responses, see "7.5 Reading the variable area" (P.7-10).

## ■ Read setting data (Communication/Modbus)

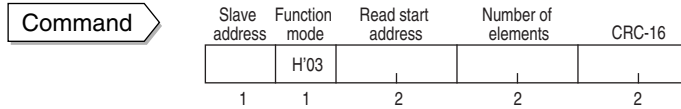

| Address                         | Explanation |                                 |                                |
|---------------------------------|-------------|---------------------------------|--------------------------------|
|                                 | Ch          |                                 |                                |
|                                 | 1           | Setting data of setting area 0  |                                |
| H'0600 to 060E                  |             | RUN level                       |                                |
| H'0700 to 0744                  |             | Adjustment level                |                                |
| H'0800 to 0818                  |             | Adjustment level 2              |                                |
| H'0900 to 09DE                  |             | Bank setting level              |                                |
| H'0A00 to 0A8E                  |             | PID setting level               |                                |
| H'0B00 to 0B6E                  |             | Approximation setting level     |                                |
|                                 |             | Setting data of setting area 1  |                                |
| H'0C00 to 0C20                  |             | Input initial setting level     |                                |
| H'0D00 to 0D26                  |             | Control initial setting level   |                                |
| H'0E00 to 0E60                  |             | Control initial setting 2 level |                                |
| H'0F00 to 0F20                  |             | Alarm setting level             |                                |
| H'1000 to 100E                  |             | Display adjustment level        |                                |
| H'1100 to 110C                  |             | Communications setting level    |                                |
| H'1200 to 1218                  |             | Special function setting level  |                                |
| H'1300 to 1332                  |             | Expansion control setting level |                                |
| H'4000 added to above addresses |             | 2                               | Same setting data as channel 1 |
| H'8000 added to above addresses |             | 3                               | Same setting data as channel 1 |
| H'C000 added to above addresses | 4           | Same setting data as channel 1  |                                |

This command is used to read setting data. The number of elements can be set from H'0004 to 006A (4 to 106) to allow successive reading of 2 to 53 items of setting data in contiguous addresses.

To specify the variable type or address, see "Appendix Setting list" (P.A-6). The upper limit of an address will vary depending on the variable type.

This command can be used in both setting area 0 and setting area 1.

When used in setting area 1, the response for the remote SP monitor, ramp SP monitor, and valve opening monitor is "0" and the response for the status is as indicated in the notes in "Appendix Setting list Status" (P.A-8).

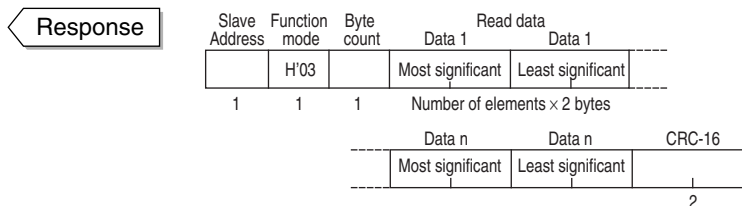

The above indicates a normal end. For information on error responses, see "7.5 Reading the variable area" (P.7-10).

### Write setting data to protect level

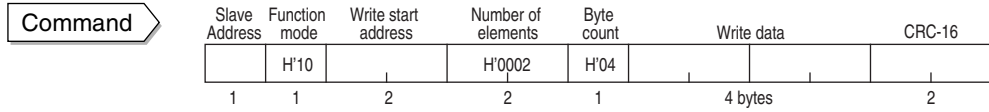

| Address | Setting data                  |
|---------|-------------------------------|
| H'0500  | Operation adjustment protect  |
| H'0502  | Initial setting level protect |
| H'0504  | Setting change protect        |
| H'0506  | PF key protect                |

This command writes setting data to Protect level. Protect level is explained in "4.1 Setting levels and key operation" (P.4-2).

This command is used in setting area 0. If used in setting area 1, an error will result.

To use this command, use the "Write via communication" operation command to enable "Write via communication", and then use the "Move to protect level" operation command to move to "Protect level".

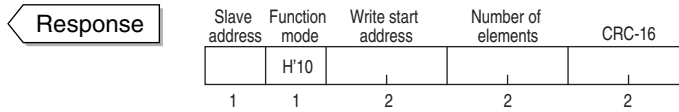

The above indicates a normal end. For information on error responses, see "7.6 Writing to the variable area" (P.7-12).

### Write setting data (Communication/Modbus)

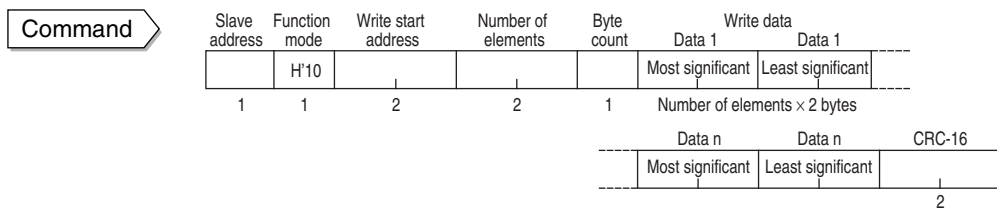



| Address                         | Explanation |                                 |                                |
|---------------------------------|-------------|---------------------------------|--------------------------------|
|                                 | Ch          |                                 |                                |
|                                 | 1           | Setting data of setting area 0  |                                |
| H'0600 to 060E                  |             | RUN level                       |                                |
| H'0700 to 0744                  |             | Adjustment level                |                                |
| H'0800 to 0818                  |             | Adjustment level 2              |                                |
| H'0900 to 09DE                  |             | Bank setting level              |                                |
| H'0A00 to 0A8E                  |             | PID setting level               |                                |
| H'0B00 to 0B6E                  |             | Approximation setting level     |                                |
|                                 |             | Setting data of setting area 1  |                                |
| H'0C00 to 0C20                  |             | Input initial setting level     |                                |
| H'0D00 to 0D26                  |             | Control initial setting level   |                                |
| H'0E00 to 0E60                  |             | Control initial setting 2 level |                                |
| H'0F00 to 0F20                  |             | Alarm setting level             |                                |
| H'1000 to 100E                  |             | Display adjustment level        |                                |
| H'1100 to 110C                  |             | Communications setting level    |                                |
| H'1200 to 1218                  |             | Special function setting level  |                                |
| H'1300 to 1332                  |             | Expansion control setting level |                                |
| H'4000 added to above addresses |             | 2                               | Same setting data as channel 1 |
| H'8000 added to above addresses |             | 3                               | Same setting data as channel 1 |
| H'C000 added to above addresses |             | 4                               | Same setting data as channel 1 |

This command is used to write setting data. The number of elements can be set from H'0004 to 0068 (4 to 104) to allow successive writing of 2 to 52 items of setting data in contiguous addresses.

To specify the variable type or address, see "Appendix Setting list" (P.A-6).

Write setting data to setting area 1 from setting area 1. If written from setting area 0, an error will result.

To use this command, "Write via communication" must be enabled using the "Write via communication" operation command.

To store setting data of Operation and Adjustment setting levels in non-volatile memory, select "Backup" with the "Write mode" command. If not set to "Backup", the setting data will not remain in memory when the power is turned off. For more information on Operation and Adjustment levels, see "4.1 Setting levels and key operation" (P.4-2).

Response

| Slave address | Function mode | Write start address | Number of elements | CRC-16 |
|---------------|---------------|---------------------|--------------------|--------|
| 1             | H'10          | 2                   | 2                  | 2      |

The above indicates a normal end. For information on error responses, see "7.6 Writing to the variable area" (P.7-12).

## Write via communication

| Command       |               |                     |      |                  |                     |         |
|---------------|---------------|---------------------|------|------------------|---------------------|---------|
| Slave address | Function mode | Write start address |      | Instruction code | Related information | CRC-16  |
| 1             | H'06          | H'00                | H'00 | H'00             |                     |         |
| 1             | 1             | 2                   |      | 2                |                     | 2 bytes |

| Related information | Description                     |
|---------------------|---------------------------------|
| H'00                | Write via communication disable |
| H'01                | Write via communication enable  |

This command is used to enable or disable "Write via communication". When sent it changes the set value of "Write via communication."

When Write via communication is disabled, communication cannot be used to write setting data or send operation commands such as Run/Stop.

**The initial setting is "disabled".**

This command can be used in both setting area 0 and setting area 1.

| Response      |               |                     |      |                  |                     |         |
|---------------|---------------|---------------------|------|------------------|---------------------|---------|
| Slave address | Function mode | Write start address |      | Instruction code | Related information | CRC-16  |
| 1             | H'06          | H'00                | H'00 | H'00             |                     |         |
| 1             | 1             | 2                   |      | 2                |                     | 2 bytes |

The above indicates a normal end. For information on error responses, see "7.7 Operation commands (Communication/Modbus)" (P.7-14).

## Control Run / Control Stop

| Command       |               |                     |      |                  |                     |         |
|---------------|---------------|---------------------|------|------------------|---------------------|---------|
| Slave address | Function mode | Write start address |      | Instruction code | Related information | CRC-16  |
| 1             | H'06          | H'00                | H'00 | H'01             |                     |         |
| 1             | 1             | 2                   |      | 2                |                     | 2 bytes |

| Related information | Description |               |
|---------------------|-------------|---------------|
|                     | Ch          | Control state |
| H'00                | 1           | Run           |
| H'01                |             | Stop          |
| H'10                | 2           | Run           |
| H'11                |             | Stop          |
| H'20                | 3           | Run           |
| H'21                |             | Stop          |
| H'30                | 4           | Run           |
| H'31                |             | Stop          |
| H'F0                | All         | Run           |
| H'F1                |             | Stop          |

This is used to run or stop control.

This command can be used in both setting area 0 and setting area 1.

When the control mode is set to cascade control, perform the Run/ Stop operation command of channel 2.

If "All" channels are selected, only those that are enabled will be affected by this command.

To use this command, "Write via communication" must be enabled using the "Write via communication" operation command.

Response

| Slave address | Function mode | Write start address |      | Instruction code | Related information | CRC-16  |
|---------------|---------------|---------------------|------|------------------|---------------------|---------|
| 1             | H'06          | H'00                | H'00 | H'01             |                     |         |
| 1             | 1             | 2                   |      | 2                |                     | 2 bytes |

The above indicates a normal end. For information on error responses, see "7.7 Operation commands (Communication/Modbus)" (P.7-14).

## Bank change

Command

| Slave address | Function mode | Write start address |      | Instruction code | Related information | CRC-16  |
|---------------|---------------|---------------------|------|------------------|---------------------|---------|
| 1             | H'06          | H'00                | H'00 | H'02             |                     |         |
| 1             | 1             | 2                   |      | 2                |                     | 2 bytes |

| Related information | Description |                   |
|---------------------|-------------|-------------------|
|                     | Ch          | Selected Bank No. |
| H'00 to 07          | 1           | 0 to 7            |
| H'10 to 17          | 2           | 0 to 7            |
| H'20 to 27          | 3           | 0 to 7            |
| H'30 to 37          | 4           | 0 to 7            |
| H'F0 to F7          | All         | 0 to 7            |

This command is used to change banks (there are 8 banks numbered 0 to 7). An SP, alarm values, and a PID Set No. are stored in each bank.

This command can be used in both setting area 0 and setting area 1. An operation error will result if AT is running in the selected channel.

To use this command, "Write via communication" must be enabled using the "Write via communication" operation command.

Response

| Slave address | Function mode | Write start address |      | Instruction code | Related information | CRC-16  |
|---------------|---------------|---------------------|------|------------------|---------------------|---------|
| 1             | H'06          | H'00                | H'00 | H'02             |                     |         |
| 1             | 1             | 2                   |      | 2                |                     | 2 bytes |

The above indicates a normal end. For information on error responses, see "7.7 Operation commands (Communication/Modbus)" (P.7-14).

## ■ AT execute

### Command

| Slave address | Function mode | Write start address |      | Instruction code | Related information | CRC-16  |
|---------------|---------------|---------------------|------|------------------|---------------------|---------|
| 1             | H'06          | H'00                | H'00 | H'03             |                     |         |
| 1             | 1             | 2                   |      | 2                |                     | 2 bytes |

| Related information | Description |  |
|---------------------|-------------|--|
|                     | Ch          | Command  |
| H'00 to 08          | 1           | 00: Currently selected PID Set No.<br>01 to 08: Specifies PID Set No. 1 to 8 |
| H'10 to 18          | 2           | 10: Currently selected PID Set No.<br>11 to 18: Specifies PID Set No. 1 to 8 |
| H'20 to 28          | 3           | 20: Currently selected PID Set No.<br>21 to 28: Specifies PID Set No. 1 to 8 |
| H'30 to 38          | 4           | 30: Currently selected PID Set No.<br>31 to 38: Specifies PID Set No. 1 to 8 |
| H'F0 to F8          | All         | F0: Currently selected PID Set No.<br>F1 to F8: Specifies PID Set No. 1 to 8 |

This command runs AT. On the E5AR/ER, the PID Set No. must be specified when running AT.

To specify the currently selected PID Set No. (the PID set currently used for operation), set the lower byte of the related information to "0".

This command is used in setting area 0. If used in setting area 1, an operation error will result. An operation error will also result in the following situations:

- "Run/Stop" of the specified channel is set to "Stop".
- "Auto / Manual" of the specified channel is set to "Manual".

To use this command, "Write via communication" must be enabled using the "Write via communication" operation command.

### Response

| Slave address | Function mode | Write start address |      | Instruction code | Related information | CRC-16  |
|---------------|---------------|---------------------|------|------------------|---------------------|---------|
| 1             | H'06          | H'00                | H'00 | H'03             |                     |         |
| 1             | 1             | 2                   |      | 2                |                     | 2 bytes |

The above indicates a normal end. For information on error responses, see "7.7 Operation commands (Communication/Modbus)" (P.7-14).

## ■ AT cancel

### Command

| Slave address | Function mode | Write start address |      | Instruction code | Related information | CRC-16  |
|---------------|---------------|---------------------|------|------------------|---------------------|---------|
| 1             | H'06          | H'00                | H'00 | H'0A             |                     |         |
| 1             | 1             | 2                   |      | 2                |                     | 2 bytes |

| Related information | Description |         |
|---------------------|-------------|---------|
|                     | Ch          | Command |
| H'00                | 1           | AT stop |
| H'10                | 2           | AT stop |
| H'20                | 3           | AT stop |
| H'30                | 4           | AT stop |
| H'F0                | All         | AT stop |

This command stops AT.

This command is used in setting area 0. If used in setting area 1, an operation error will result. An operation error will also result in the following situations:

- "Run/Stop" of the specified channel is set to "Stop".
- "Auto / Manual" of the specified channel is set to "Manual".

To use the command, "Write via communication" must be enabled using the "Write via communication" operation command.

Response

| Slave address | Function mode | Write start address | Instruction code | Related information | CRC-16  |
|---------------|---------------|---------------------|------------------|---------------------|---------|
| 1             | H'06          | H'00 H'00           | H'0A             |                     |         |
| 1             | 1             | 2                   | 2                |                     | 2 bytes |

The above indicates a normal end. For information on error responses, see "7.7 Operation commands (Communication/Modbus)" (P.7-14).

## Write mode

Command

| Slave address | Function mode | Write start address | Instruction code | Related information | CRC-16  |
|---------------|---------------|---------------------|------------------|---------------------|---------|
| 1             | H'06          | H'00 H'00           | H'04             |                     |         |
| 1             | 1             | 2                   | 2                |                     | 2 bytes |

| Related information | Description    |
|---------------------|----------------|
| H'00                | Backup mode    |
| H'01                | RAM write mode |

This command is used to select backup mode or RAM write mode.

**The initial setting is backup mode.**

This command can be used in both setting area 0 and setting area 1.

To use this command, "Write via communication" must be enabled using the "Write via communication" operation command.

| Write mode     | Explanation   |
|----------------|---|
| Backup mode    | When communication is used to write setting data of Operation, Adjustment, Adjustment 2, Bank setting, PID setting, or Approximation setting level, the data is also written to internal non-volatile memory.   |
| RAM write mode | When communication is used to write setting data of Operation, Adjustment, Adjustment 2, Bank setting, PID setting, or Approximation setting level, the data is not written to internal non-volatile memory.<br>When SP tracking or PV tracking is ON and the mode is changed to remote SP mode or manual mode, the SP is not written to internal non-volatile memory.<br>Note that when a change is made by key operation, the data is written to non-volatile memory. |

When the write mode is changed from RAM write mode to Backup mode, the setting data of Operation, Adjustment, Adjustment 2, Bank setting, PID setting, and Approximation setting levels is written to internal non-volatile memory. Each level is explained in "4.1 Setting levels and key operation" (P.4-2).



The time required for RAM backup varies depending on the number of settings that were changed in RAM backup mode. The more settings that were changed, the longer the time required. For example, if all settings in Operation, Adjustment, Adjustment 2, Bank setting, PID setting, and Approximation levels were changed, the most time would be required, which is about 2 seconds.

| Response      |               |                     |      |                  |                     |         |
|---------------|---------------|---------------------|------|------------------|---------------------|---------|
| Slave address | Function mode | Write start address |      | Instruction code | Related information | CRC-16  |
| 1             | H'06          | H'00                | H'00 | H'04             |                     |         |
| 1             | 1             | 2                   |      | 2                |                     | 2 bytes |

The above indicates a normal end. For information on error responses, see "7.7 Operation commands (Communication/Modbus)" (P.7-14).

## ■ RAM data store

| Command       |               |                     |      |                  |                     |         |
|---------------|---------------|---------------------|------|------------------|---------------------|---------|
| Slave address | Function mode | Write start address |      | Instruction code | Related information | CRC-16  |
|               | H'06          | H'00                | H'00 | H'05             | H'00                |         |
| 1             | 1             | 2                   |      | 2                |                     | 2 bytes |

This writes the setting data of Operation and Adjustment levels to internal non-volatile memory. Operation and Adjustment levels are explained in "4.1 Setting levels and key operation" (P.4-2).

This command can be used in both setting area 0 and setting area 1.

To use this command, "Write via communication" must be enabled using the "Write via communication" operation command.

| Response      |               |                     |      |                  |                     |         |
|---------------|---------------|---------------------|------|------------------|---------------------|---------|
| Slave address | Function mode | Write start address |      | Instruction code | Related information | CRC-16  |
|               | H'06          | H'00                | H'00 | H'05             | H'00                |         |
| 1             | 1             | 2                   |      | 2                |                     | 2 bytes |

The above indicates a normal end. For information on error responses, see "7.7 Operation commands (Communication/Modbus)" (P.7-14).

## ■ Software reset

| Command       |               |                     |      |                  |                     |         |
|---------------|---------------|---------------------|------|------------------|---------------------|---------|
| Slave address | Function mode | Write start address |      | Instruction code | Related information | CRC-16  |
|               | H'06          | H'00                | H'00 | H'06             | H'00                |         |
| 1             | 1             | 2                   |      | 2                |                     | 2 bytes |

A software reset causes the same operation as turning the power off and on.

This command can be used in both setting area 0 and setting area 1.

To use this command, "Write via communication" must be enabled using the "Write via communication" operation command.

| Response      |  |
|---------------|--|
| (No response) |  |

**(No response)**

A response is not returned to this operation command.

## ■ Move to setting area 1

Command

| Slave address | Function mode | Write start address |      | Instruction code | Related information | CRC-16  |
|---------------|---------------|---------------------|------|------------------|---------------------|---------|
| 1             | H'06          | H'00                | H'00 | H'07             | H'00                |         |
| 1             | 1             | 2                   |      | 2                |                     | 2 bytes |

Use this command to move to setting area 1.

The command is used in setting area 0. Nothing happens if the command is used in setting area 1.

If the command is used when "Initial setting level protect" is set to "2 (Disable move to input initial setting level)", an operation error will result.

To use this command, "Write via communication" must be enabled using the "Write via communication" operation command.

Response

| Slave address | Function mode | Write start address |      | Instruction code | Related information | CRC-16  |
|---------------|---------------|---------------------|------|------------------|---------------------|---------|
| 1             | H'06          | H'00                | H'00 | H'07             | H'00                |         |
| 1             | 1             | 2                   |      | 2                |                     | 2 bytes |

The above indicates a normal end. For information on error responses, see "7.7 Operation commands (Communication/Modbus)" (P.7-14).

## ■ Move to protect level

Command

| Slave address | Function mode | Write start address |      | Instruction code | Related information | CRC-16  |
|---------------|---------------|---------------------|------|------------------|---------------------|---------|
| 1             | H'06          | H'00                | H'00 | H'08             | H'00                |         |
| 1             | 1             | 2                   |      | 2                |                     | 2 bytes |

Use this command to move to protect level. Protect level is explained in "4.1 Setting levels and key operation" (P.4-2).

This command is used in setting area 0. If used in setting area 1, an operation error will result.

To use this command, "Write via communication" must be enabled using the "Write via communication" operation command.

Response

| Slave address | Function mode | Write start address |      | Instruction code | Related information | CRC-16  |
|---------------|---------------|---------------------|------|------------------|---------------------|---------|
| 1             | H'06          | H'00                | H'00 | H'08             | H'00                |         |
| 1             | 1             | 2                   |      | 2                |                     | 2 bytes |

The above indicates a normal end. For information on error responses, see "7.7 Operation commands (Communication/Modbus)" (P.7-14).

## ■ Auto / Manual

Command

| Slave address | Function mode | Write start address |      | Instruction code | Related information | CRC-16 |
|---------------|---------------|---------------------|------|------------------|---------------------|--------|
|               | H'06          | H'00                | H'00 | H'09             |                     |        |
| 1             | 1             | 2                   |      | 2                | 2 bytes             |        |

| Related information | Description |                |
|---------------------|-------------|----------------|
|                     | Ch          | Operation mode |
| H'00                | 1           | Auto           |
| H'01                |             | Manual         |
| H'10                | 2           | Auto           |
| H'11                |             | Manual         |
| H'20                | 3           | Auto           |
| H'21                |             | Manual         |
| H'30                | 4           | Auto           |
| H'31                |             | Manual         |
| H'F0                | All         | Auto           |
| H'F1                |             | Manual         |

Use this command to select auto or manual operation.

This command is used in setting area 0. If used in setting area 1, an operation error will result.

To use this command, "Write via communication" must be enabled using the "Write via communication" operation command.

When the control mode is set to cascade control, perform the Auto / Manual operation command of CH2.

Response

| Slave address | Function mode | Write start address |      | Instruction code | Related information | CRC-16 |
|---------------|---------------|---------------------|------|------------------|---------------------|--------|
|               | H'06          | H'00                | H'00 | H'09             |                     |        |
| 1             | 1             | 2                   |      | 2                | 2 bytes             |        |

The above indicates a normal end. For information on error responses, see "7.7 Operation commands (Communication/Modbus)" (P.7-14).

## ■ Initialize settings

Command

| Slave address | Function mode | Write start address |      | Instruction code | Related information | CRC-16 |
|---------------|---------------|---------------------|------|------------------|---------------------|--------|
|               | H'06          | H'00                | H'00 | H'0B             | H'00                |        |
| 1             | 1             | 2                   |      | 2                | 2 bytes             |        |

This returns all settings to the initial settings.

This command is used in setting area 1. If used in setting area 0, an operation error will result.

To use this command, "Write via communication" must be enabled using the "Write via communication" operation command.

Response

| Slave address | Function mode | Write start address |      | Instruction code | Related information | CRC-16 |
|---------------|---------------|---------------------|------|------------------|---------------------|--------|
|               | H'06          | H'00                | H'00 | H'0B             | H'00                |        |
| 1             | 1             | 2                   |      | 2                | 2 bytes             |        |

The above indicates a normal end. For information on error responses, see "7.7 Operation commands (Communication/Modbus)" (P.7-14).



## ■ Cancel latch

Command

| Slave address | Function mode | Write start address |      | Instruction code | Related information | CRC-16  |
|---------------|---------------|---------------------|------|------------------|---------------------|---------|
| 1             | H'06          | H'00                | H'00 | H'0C             |                     |         |
| 1             | 1             | 2                   |      | 2                |                     | 2 bytes |

| Related information | Description |                    |
|---------------------|-------------|--------------------|
|                     | Ch          | Command            |
| H'00                | 1           | Cancel alarm latch |
| H'10                | 2           | Cancel alarm latch |
| H'20                | 3           | Cancel alarm latch |
| H'30                | 4           | Cancel alarm latch |
| H'F0                | All         | Cancel alarm latch |

This command cancels alarm latch. The command is used when the alarm latch function is in use.

This command can be used in both setting area 0 and setting area 1. If AT is being run in the specified channel, an operation error will result.

To use this command, "Write via communication" must be enabled using the "Write via communication" operation command.

Response

| Slave address | Function mode | Write start address |      | Instruction code | Related information | CRC-16  |
|---------------|---------------|---------------------|------|------------------|---------------------|---------|
| 1             | H'06          | H'00                | H'00 | H'0C             |                     |         |
| 1             | 1             | 2                   |      | 2                |                     | 2 bytes |

The above indicates a normal end. For information on error responses, see "7.7 Operation commands (Communication/Modbus)" (P.7-14).

## ■ SP mode

Command

| Slave address | Function mode | Write start address |      | Instruction code | Related information | CRC-16  |
|---------------|---------------|---------------------|------|------------------|---------------------|---------|
| 1             | H'06          | H'00                | H'00 | H'0D             |                     |         |
| 1             | 1             | 2                   |      | 2                |                     | 2 bytes |

| Related information | Description |                            |
|---------------------|-------------|----------------------------|
|                     | Ch          | Command                    |
| H'00                | 1           | Local SP                   |
| H'01                |             | Remote SP                  |
| H'10                | 2           | Local SP (Cascade open)    |
| H'11                |             | Remote SP (Cascade closed) |
| H'F0                | All         | Local SP                   |
| H'F1                |             | Remote SP                  |

Use this command to select the SP mode (Local SP / Remote SP). The command can be used when cascade control or remote SP is in use.

This command can be used in both setting area 0 and setting area 1. If AT is being run in the specified channel, an operation error will result.

To use this command, "Write via communication" must be enabled using the "Write via communication" operation command.

When the control mode is set to cascade control, perform the local SP/ remote SP operation command of CH2.

Response

| Slave address | Function mode | Write start address |      | Instruction code | Related information | CRC-16  |
|---------------|---------------|---------------------|------|------------------|---------------------|---------|
| 1             | H'06          | H'00                | H'00 | H'0D             |                     |         |
| 1             | 1             | 2                   | 2    | 2                |                     | 2 bytes |

The above indicates a normal end. For information on error responses, see "7.7 Operation commands (Communication/Modbus)" (P.7-14).

## ■ Echo back test

Command

| Slave address | Function mode | Write start address |      | Test data | CRC-16  |
|---------------|---------------|---------------------|------|-----------|---------|
| 1             | H'08          | H'00                | H'00 |           |         |
| 1             | 1             | 2                   | 2    | 2         | 2 bytes |

This command is used to perform an echo back test.

The command can be used in any state of the E5AR/ER.

The test data can be any two bytes of hexadecimal data.

Response

| Slave address | Function mode | Write start address |      | Test data | CRC-16  |
|---------------|---------------|---------------------|------|-----------|---------|
| 1             | H'08          | H'00                | H'00 |           |         |
| 1             | 1             | 2                   | 2    | 2         | 2 bytes |

The above indicates a normal end. For information on error responses, see "7.7 Operation commands (Communication/Modbus)" (P.7-14).



# Section 8 Setting data

|      |   |       |      |
|------|---|-------|------|
| 8.1  | How to use this chapter                 | ..... | 8-2  |
| 8.2  | Protect level (L.PrL)                   | ..... | 8-3  |
| 8.3  | Operation level ( )                     | ..... | 8-5  |
| 8.4  | Adjustment level (L.AdJ)                | ..... | 8-12 |
| 8.5  | Adjustment 2 level (L.Ad2)              | ..... | 8-22 |
| 8.6  | Bank setting level (L.brM)              | ..... | 8-26 |
| 8.7  | PID setting level (L.PId)               | ..... | 8-30 |
| 8.8  | Approximation setting level (L.EEL)     | ..... | 8-33 |
| 8.9  | Input initial setting level (L.I)       | ..... | 8-35 |
| 8.10 | Control initial setting level (L.I)     | ..... | 8-41 |
| 8.11 | Control initial setting 2 level (L.I2)  | ..... | 8-45 |
| 8.12 | Alarm setting level (L.A)               | ..... | 8-53 |
| 8.13 | Display adjustment level (L.Y)          | ..... | 8-59 |
| 8.14 | Communication setting level (L.S)       | ..... | 8-63 |
| 8.15 | Advanced function setting level (L.AdF) | ..... | 8-67 |
| 8.16 | Expansion control setting level (L.EUL) | ..... | 8-72 |

## 8.1 How to use this section

### ● Marks used in this section



Explains the meaning and function of a setting data item.



Shows the setting range and initial setting of a setting data item.



Used for monitor values.



Explains a procedure for operating the E5AR/ER.



Indicates where a setting data item is explained and notes related setting data items.

### ● Display conditions for related setting data

A setting will only appear in the display of the E5AR/ER when the conditions of use for the setting are satisfied (conditions of use are indicated to the right of each setting in this section). Protected settings are not displayed regardless of the conditions of use, although they are in effect.

In the case of settings that can be configured separately for each channel on a multi-point input type, CH appears to upper left of each of these settings in this section.

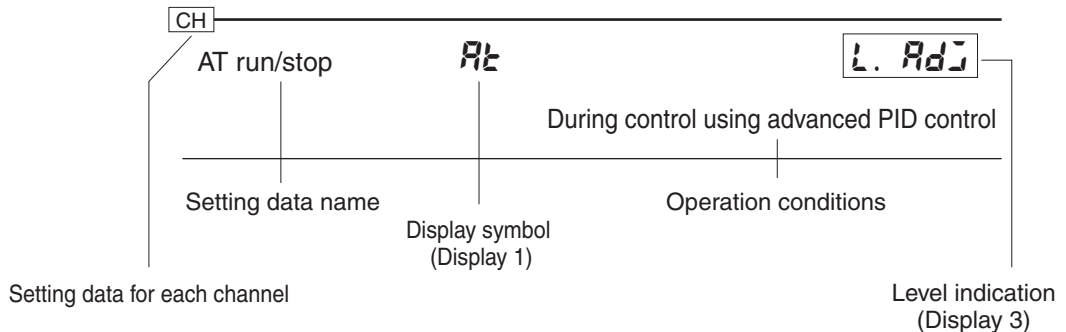

### ● Order of explanation of settings

Settings are explained by level.

## 8.2 Protect level (L.Pr.t)

Protect level consists of four types of protection: "Operation adjustment protect", "Initial setting protect", "Setting change protect", and "PF key protect". Each is used to protect the corresponding settings and prevent accidental changes to the settings.

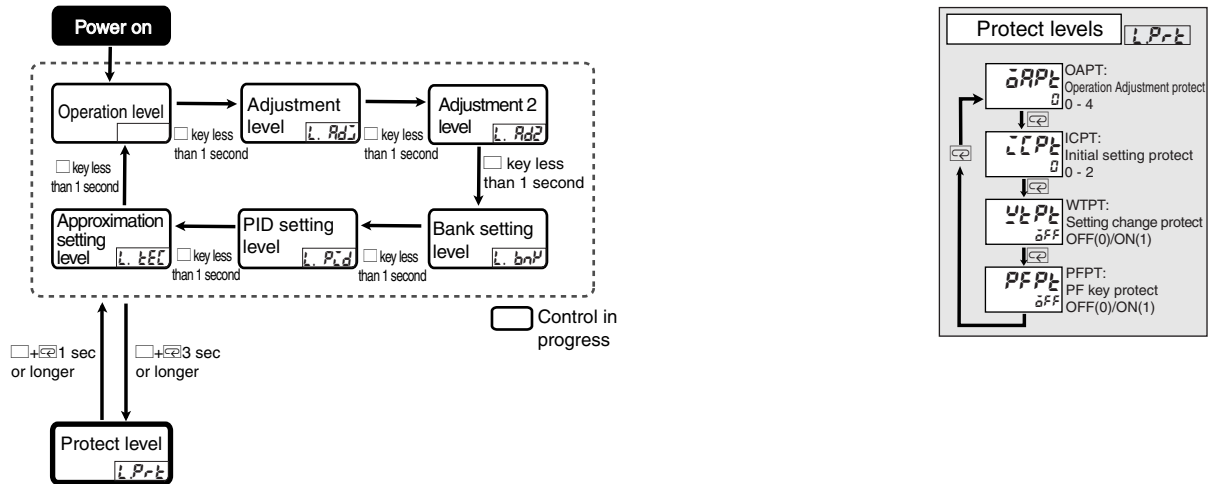

|                              |      |        |
|------------------------------|------|--------|
| Operation adjustment protect | OAPT | L.Pr.t |
| Initial setting protect      | ICPT |        |
| Setting change protect       | WTPT |        |
| PF key protect               | PFPT |        |

The range of setting data protected is indicated. Initial settings are shaded.



### • Operation adjustment protect

Restricts key operation in the Operation, Adjustment, Adjustment 2, Bank setting, PID setting, Approximation setting, and Monitor item levels.



| Setting values | Operation |        | Adjustment Adjustment 2 | Bank settings<br>PID settings<br>Approximation settings<br>Monitor items |
|----------------|-----------|--------|-------------------------|--|
|                | "PV/SP"   | Others |                         |  |
| 0              | ⊙         | ⊙      | ⊙                       | ⊙  |
| 1              | ⊙         | ⊙      | ⊙                       | ×  |
| 2              | ⊙         | ⊙      | ×                       | ×  |
| 3              | ⊙         | ×      | ×                       | ×  |
| 4              | ○         | ×      | ×                       | ×  |

⊙: Display/change: Yes ○: Display: Yes ×: Display/Change levels: No

When the set value is "0", protection is not enabled.



**• Initial setting protect**

Restricts movement to the Input initial setting, Control initial setting, Control initial setting 2, Alarm setting, Display adjustment, and Communication setting level.



| Setting values | Move to Input initial setting level                   | Move to Control initial setting, Control initial setting 2, Alarm setting, Display adjustment, and Communication setting level |
|----------------|---|--|
| 0              | Yes (shows "Advanced function setting level")         | Yes  |
| 1              | Yes (Does not show "Advanced function setting level") | Yes  |
| 2              | No  | No   |

- When "Initial setting level protect" is set to "2", nothing happens when the level key is held down for 1 second to move to Input initial setting level from Operation, Adjustment, Adjustment 2, Bank setting, PID setting, Approximation setting, or Monitor item level. (The blinking display to indicate the move does not appear.)



**• Setting change protect**

Prevents use of the keys.



| Setting value | Change settings by key operation | Remarks (exceptions)  |
|---------------|----------------------------------|---|
| OFF           | Yes                              | —   |
| ON            | No                               | <ul style="list-style-type: none"> <li>• All setting data on Protect level</li> <li>• "Move to special function level"</li> <li>• "Move to calibration level"</li> <li>• "Display bank selection"</li> <li>• "Display PID selection"</li> </ul> |

- "Setting change protect" is initially set to "OFF".



**• PF key protect**

Prevents use of the PF1/PF2 keys.



| Setting value | Change settings by key operation  |
|---------------|---|
| OFF           | PF1/PF2 keys are enabled  |
| ON            | PF1/PF2 keys are disabled (operation as a function key and channel key is disabled) |

- "PF key protect" is initially set to "OFF".

# 8.3 Operation level ( )

Display this level to operate the control system. The SP can be set and the PV monitored in this level.

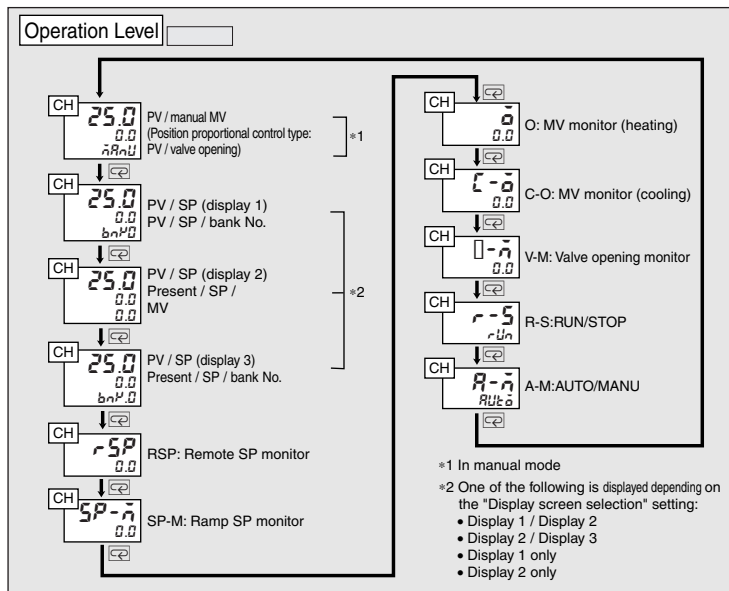
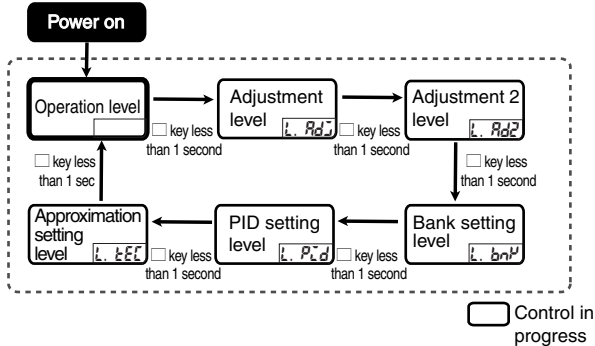

CH Manual MV

Manual operation

Setting data



- This sets the MV or valve opening during manual operation. On a standard type the MV is changed by pressing the keys. On a position proportional type, the key turns on "open" and the key turns on "close".
- On a standard type Display 1 shows the PV and Display 2 shows the MV.



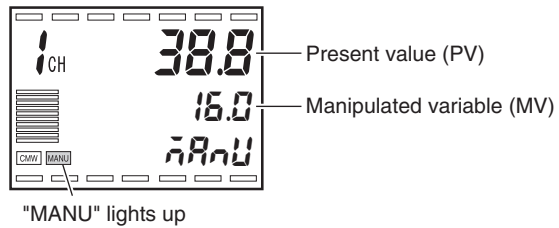

When changed with the keys, the MV is output once every 50 ms and updated in the system.

- When a potentiometer is connected to a position proportional type, Display 1 shows the PV and Display 2 shows the valve opening. When a potentiometer is not connected to a position proportional type, Display 2 shows "-----".

With potentiometer

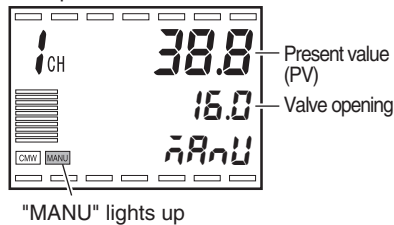

Without potentiometer

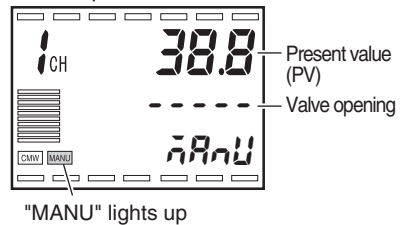

- In manual mode, operation is performed manually and the "MANU" indicator lights up.
- "Manual output method" is used to select the MV that is used when entering manual mode. The MV prior to entering manual mode can be held, or the manual MV default value can be used.
- Switching between manual and auto mode is accomplished with the key, or with "Auto/Manual" in Operation level. If either "PF1 setting" or "PF2 setting" is set to "A-M" ( key), "Auto/Manual" will not appear in operation mode and only the key is used for switching.
  - Switching between Auto and Manual with the key  
To switch modes, hold down the key for at least one second in Operation, Adjustment, Adjustment 2, Bank setting, PID setting, Approximation setting, Monitor item, or Protect level.
  - Switching between Auto and Manual with "Auto/Manual"  
To switch modes, change the setting of "Auto/Manual" in Operation level.
- During cascade control, if the primary loop is switched to manual control when the secondary loop is in any of the following conditions, the manual MV is disabled.
  - The SP mode of the secondary loop is local (cascade open).
  - The secondary loop is in manual mode.
  - "Operation at error" is taking place in the secondary loop.



• Standard type

| Control method  | Setting range   | Units | Default value |
|-----------------|-----------------|-------|---------------|
| Standard        | -5.0 to 105.0   | %     | *1            |
| Heating/cooling | -105.0 to 105.0 | %     | *1            |

\*1 "Manual output method" (Expansion control setting level) selects the MV that is used when manual mode is entered. The MV prior to entering manual mode can be held, or the manual MV default value can be used.

• Position proportional type

| Control method        | Monitor range  | Units |
|-----------------------|----------------|-------|
| Position proportional | -10.0 to 110.0 | %     |



● Related setting data

"Auto/Manual" (Operation level) (P.8-11)

"PF1 setting", "PF2 setting" (Advanced function setting level) (P.8-68)

"Manual output method", "Manual MV default value" (Expansion control setting level) (P.8-77)

CH

PV/SP (Display 1)

PV/SP (Display 2)

PV/SP (Display 3)

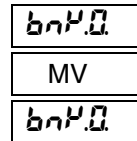

- Display 1 shows the PV and Display 2 shows the SP. The SP can be set.
- Either the local SP or the remote SP is shown depending on the selected SP mode. In the case of remote SP, the value can only be monitored.

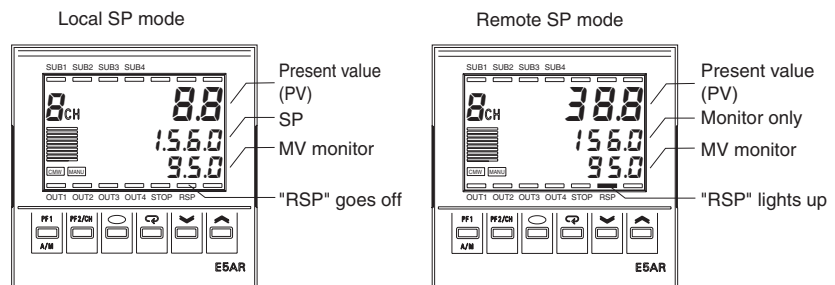

- When using a bank in local SP mode, a link is created to the local SP of the selected bank. For example, if Bank 3 is selected, the local SP of Bank 3 appears in Display 2, and when the value is changed, the value of "Bank 3 local SP" (Bank setting level) also changes.

- The decimal point position is determined by the selected sensor in the case of temperature input, and by scaling in the case of analog input. If "Display digits after PV decimal point" is set to "OFF" for temperature input, digits following the decimal point are not shown.



Setting

|    | Monitor range   | Units |
|----|---|-------|
| PV | "Appendix Sensor input setting ranges · Indicator (control) ranges" (P.A-4) | EU    |

|    | Setting or monitor range  | Units | Default value |
|----|---|-------|---------------|
| PV | Local SP: SP lower limit to SP upper limit  | EU    | 0.0           |
|    | Remote SP: Remote SP lower limit to remote SP upper limit<br>Note that the SP limits are in effect. | EU    | -             |

At "Display 1" "Display 2", the bank number appears in Display 3.

At "Display 2", the MV appears in Display 3.

"Display screen selection" (Display adjustment level) can be used to set the display sequence to Display 1/Display 2, Display 2/Display 3, Display 1 only, or Display 2 only.

The initial setting is Display 2/Display 3; PV/SP/MV, PV/SP/Bank No.



Reference

- Related setting data
  - "Input \* type" (Input initial setting level) (P.8-36)
  - "Input\* temperature units" (Input initial setting level) (P.8-37)
  - "Scaling input value 1", "Scaling display value 1", "Scaling input value 2", "Scaling display value 2", "Decimal point position" (Input initial setting level) (P.8-37)
  - "Remote SP upper limit", "Remote SP lower limit" (Input initial setting level) (P.8-38)
  - "PV decimal point display" (Input initial setting level) (P.8-39)
  - "SP upper limit", "SP lower limit" (Control initial setting level) (P.8-43)
  - "SP mode" (Adjustment level) (P.8-14)
  - "PV/SP display screen selection" (Display adjustment level) (P.8-60)

CH

Remote SP monitor

*r-SP*

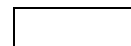

Local SP, control mode set to standard control with remote SP



Function

- This is used to monitor the remote SP while in local SP mode.
- In remote SP mode, the remote SP can be monitored in Display 2 of the PV/SP screen.

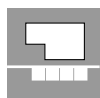

Monitor

|  | Monitor range  | Units |
|--|--|-------|
|  | Remote SP lower limit to remote SP upper limit<br>Note that the SP limits are in effect. | EU    |



- Related setting data
  - "PV/SP" (Operation level)(P.8-7)
  - "SP mode" (Adjustment level) (P.8-14)
  - "Remote SP ramp rise value" "Remote SP lower limit" (Input initial setting level) (P.8-38)
  - "Control mode" (Control initial setting level) (P.8-43)

CH

Ramp SP monitor

SP- $\bar{r}$ 

SP ramp rise value  $\neq$  0 or SP ramp fall value  $\neq$  0

- Monitors the SP during ramp.
- The ramp function limits the rate of change of the SP.
- The setting is only displayed if a value is entered for "SP ramp rise value" or "SP ramp fall value".
- For other than ramp, the SP value is the same as in "PV/SP".



Monitor

| Monitor range                    | Units |
|----------------------------------|-------|
| SP lower limit to SP upper limit | EU    |



- Related setting data
  - "PV/SP" (Operation level)(P.8-7)
  - "SP ramp time unit", "SP ramp rise value", "SP ramp fall value" (Adjustment level) (P.8-18)
  - "SP upper limit", "SP lower limit" (Control initial setting level) (P.8-43)

CH

MV monitor (heating)

 $\bar{m}$ 

Standard control, heating/cooling control

Monitors the heating MV during operation.



- Monitors the MV of standard control and the heating MV of heating/cooling control.



Monitor

| Control         | Monitor range | Units |
|-----------------|---------------|-------|
| Standard        | -5.0 to 105.0 | %     |
| Heating/cooling | 0.0 to 105.0  | %     |

CH

MV monitor (cooling)

[-̄]

Control mode is heating/cooling control

Monitors the cooling MV during operation.



- Monitors the cooling MV during heating/cooling control



| Control         | Monitor range | Units |
|-----------------|---------------|-------|
| Heating/cooling | 0.0 to 105.0  | %     |



- Related setting data  
"Control mode" (Control initial setting level) (P.8-43)

CH

Valve opening monitor

[-̄]

Position proportional type

Monitors the amount of valve opening during operation.



- Monitors the amount of valve opening during position proportional control.
- A potentiometer can be connected and "Motor calibration" can be executed to monitor the amount of valve opening.



| Control               | Monitor range  | Units |
|-----------------------|----------------|-------|
| Position proportional | -10.0 to 110.0 | %     |



- Related setting data  
"Control mode" (Control initial setting level) (P.8-43)  
"Motor calibration" (Control initial setting 2 level) (P.8-52)

CH

Run/Stop

r-s



- Use this to run or stop control.
- The initial setting is "Run".



Operation

Press the keys to select "Run: Run" or "Stop: Stop". When "Stop" is selected, the "STOP" indicator lights up.



- Related information  
"4.12 Starting and stopping control" (P.4-27)
- Related setting data  
"PF1 setting", "PF2 setting" (Advanced function setting level) (P.8-68)

CH

Auto/Manual

A-M

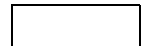

"PF1 setting" ≠ Auto/Manual  
and  
"PF2 setting" ≠ Auto/Manual



- Use to select Auto or Manual.
- The initial setting is "Auto".



Operation

Press the keys to select "Auto: Auto" for Auto mode, or "Manual: Manual" for Manual mode. When Manual mode is selected, the "MANU" indicator lights up.

- This setting does not appear if either "PF1 setting" or "PF2 setting" is set to Auto/Manual. "PF1 setting" is initially set to Auto/Manual to enable use of the key, and thus the setting does not appear.



- Related information  
"4.13 Performing manual control" (P.4-29)
- Related setting data  
"PF1 setting", "PF2 setting" (Advanced setting level) (P.8-68)

## 8.4 Adjustment level (L Ad)

This level contains settings for the purpose of adjusting control, such as change bank No., AT (Auto-tuning), enable/disable write via communication, hysteresis adjustment, input shift settings, and SP ramp settings.

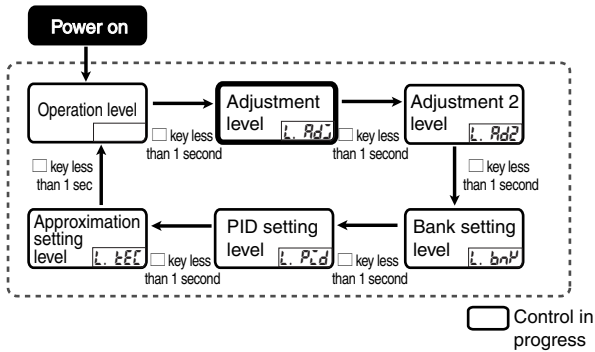

Adjustment level **L Ad**

|    |             |   |    |              |  |
|----|-------------|---|----|--------------|--|
| CH | <b>BANK</b> | BANK: Bank No. 0 - 7  | CH | <b>SPRH</b>  | SPRH: SP ramp rise value<br>0 - 99999<br>(0: Disable SP ramp function) |
| CH | <b>AT</b>   | AT: AT execute / cancel OFF / 0 - 8                             | CH | <b>SPFL</b>  | SPFL: SP ramp fall value<br>0 - 99999<br>(0: Disable SP ramp function) |
| CH | <b>CMWT</b> | CMWT: Write via communication OFF/ON                            | CH | <b>MV-S</b>  | MV-S: MV at stop<br>-5.0 - 105.0<br>(standard type)*1                  |
| CH | <b>SPMD</b> | SPMD: SP mode LSP/RSP   | CH | <b>MV-E</b>  | MV-E: MV at PV error<br>-5.0 - 105.0<br>(standard type)*1              |
| CH | <b>C-SC</b> | C-SC: Cooling coefficient<br>0.01 - 99.99                       | CH | <b>ORL</b>   | ORL: MV change rate limit (heating)<br>0.0 - 100.0                     |
| CH | <b>C-DB</b> | C-DB: Dead band<br>-199.99 - 999.99                             | CH | <b>CORL</b>  | CORL: MV change rate limit (cooling)<br>0.0 - 100.0                    |
| CH | <b>OF-R</b> | OF-R: Manual reset value<br>0.0 - 100.0                         | CH | <b>ISL.1</b> | ISL.1: Input value 1 for input correction<br>-19999 - 99999            |
| CH | <b>HYS</b>  | HYS: Hysteresis (heating)<br>0.01 - 99.99                       | CH | <b>ISS.1</b> | ISS.1: Input correction 1<br>-199.99 - 999.99                          |
| CH | <b>CHYS</b> | CHYS: Hysteresis (cooling)<br>0.01 - 99.99                      | CH | <b>ISL.2</b> | ISL.2: Input value 2 for input correction<br>-19999 - 99999            |
| CH | <b>CP</b>   | CP: Control period (heating)<br>0.2 - 99.0                      | CH | <b>ISS.2</b> | ISS.2: Input correction 2<br>-199.99 - 999.99                          |
| CH | <b>C-CP</b> | C-CP: Control period (cooling)<br>0.2 - 99.0                    | CH | <b>DOGN</b>  | DOGN: Disturbance gain<br>-1.00 - 1.00                                 |
| CH | <b>DB</b>   | DB: Position proportional dead band<br>0.1 - 10.0               | CH | <b>DOTC</b>  | DOTC: Disturbance time constant<br>0.01 - 99.99                        |
| CH | <b>OC-H</b> | OC-H: Open / close hysteresis<br>0.1 - 20.0                     | CH | <b>DO-B</b>  | DO-B: Disturbance rectification band<br>0.000 - 9.999                  |
| CH | <b>SPRU</b> | SPRU: SP ramp time unit<br>EU / s: S, EU / min: M, EU / hour: H | CH | <b>DOJW</b>  | DOJW: Disturbance judgement width<br>-99.99 - 99.99                    |

\*1 Position proportional type: Completely open / Hold / Completely closed (-1/0/1)

CH

Bank No.

bA04

L.Adj



Function

- This setting is used to specify a bank (one of Bank Nos. 0 through 7). Each bank contains an SP (local SP), alarm value, and PID set number, and these settings are stored using the bank function in Bank setting level. A bank can be specified by event input, key operation, or communication.
- This setting is used to specify a bank by key operation.



Operation

Use the keys to specify a bank No..  
The initial setting is "Currently used bank No.".



Reference

- Related setting data
  - "Bank \* Local SP" (Bank setting level) (P.8-27)
  - "Event input \* Assignment" (Control initial setting 2 level) (P.8-47)

CH

AT Execute/Cancel

At

L.Adj

In auto mode, running

This is used to run AT (Auto-tuning)



Function

- The MV is increased and decreased around the SP to obtain the characteristics of the object of control. The PID values are calculated from the results and the "Proportional band", Integral time", and "Derivative time" are automatically set.



Operation

- Normally this is "0FF". AT can be run by pressing the key to select the PID set number. AT cannot be run while control is stopped.
- Select "0" to specify the PID set currently used for control. Select a number from 1 to 8 to specify a PID set number.
- AT automatically returns to "0FF" when finished.
- The SP blinks if "PV/SP" are monitored during AT.
- The channel cannot be changed during AT.



Reference

- Related setting data
  - "PID \* Proportional band", "PID \* Integral time",
  - "PID \* Derivative time" (PID setting level) (P.8-31)



Write via communication

**Com**

**LAJ**

Models that support communication



Function

- This enables or disables the writing of setting data from a host (computer) to the controller.
- The initial setting is "Disabled: **OFF**".



Operation

Select "**ON**" to enable or "**OFF**" to disable write via communication.



Reference

- Related setting data:
  - "Communication protocol selection" (Communication setting level) (P.8-64)
  - "Communication unit No." (Communication setting level) (P.8-64)
  - "Communication speed" (Communication setting level) (P.8-64)
  - "Communication data length" (Communication setting level) (P.8-65)
  - "Communication stop bit" (Communication setting level) (P.8-65)
  - "Communication parity" (Communication setting level) (P.8-65)
  - "Transmission wait time" (Communication setting level) (P.8-66)

**CH**

SP mode

**SPnd**

**LAJ**

Control mode is standard control with remote SP, cascade control, or proportional control





Function

- Use this setting to select the SP mode.
- In local SP mode, the local SP set in the bank in the controller is used for control. In remote SP mode, the remote SP specified by an external signal (4 to 20 mA, etc.) is used.



Operation

- Use the   keys to select "**L SP**: Local SP" for local SP mode, or "**R SP**: Remote SP" for remote SP mode. When remote SP mode is selected, the "RSP" indicator lights up.
- When cascade control is used, cascade open (secondary loop independent control) takes place when the SP mode of channel 2 is local SP mode, and cascade closed (cascade control) takes place when the SP mode is remote SP mode.



Reference

- Related setting data
  - "Control mode" (Control initial setting level) (P.8-43)

CH

Cooling coefficient

[-5]

LAdj

Heating/cooling control, Advanced PID control  
(Proportional band  $\neq$  0.00)

When there is a large difference in the heating and cooling characteristics of the object and satisfactory control is not possible using the same PID constants, the heating P (proportional band) is multiplied by a coefficient for use in cooling control.



Function

The cooling P in heating/cooling control is obtained and the coefficient is set using the following equation.

$$\text{Cooling P} = \text{Cooling coefficient} \times \text{P (heating proportional band)}$$



Setting

| Setting range | Units | Default value |
|---------------|-------|---------------|
| 0.01 to 99.99 | None  | 1.00          |



Reference

- Related information  
"3.2 Heating/cooling control of a chemical reaction device" (P.3-5)
- Related setting data  
"PID\* Proportional band" (PID setting level) (P.8-31)

CH

Dead band

[-db]

LAdj

Heating/cooling control

This sets an output dead band for heating/cooling control. A negative value can also be set to create an overlap band.



Function

Set an area centered on the SP where the control amount is 0 during heating/cooling control.



Setting

| Setting range   | Units | Default value |
|-----------------|-------|---------------|
| -19.99 to 99.99 | %FS   | 0.00          |

CH

Manual reset value

[MF-r]

LAdj

Advanced PID control (Proportional band  $\neq$  0.00), Integral time = 0

Function

- This is used to set an MV for rectification during P and PD control to eliminate the offset.
- This setting only appears when Proportional band  $\neq$  0.00 and Integral time = 0.



Setting

| Setting range | Units | Default value |
|---------------|-------|---------------|
| 0.0 to 100.0  | %     | 50.0          |



Reference

- Related setting data  
"PID\* Proportional band", "PID\* Integral time ", (PID setting level) (P.8-31)

|    |                      |              |  |
|----|----------------------|--------------|--|
| CH | Hysteresis (heating) | <i>HYS</i>   | <span style="border: 1px solid black; padding: 2px;">L.Pd</span> |
|    | Hysteresis (cooling) | <i>[HYS]</i> | ON/OFF Control (P = 0.0)   |

This sets the Hysteresis to enable stable operation when control is switched ON/OFF.



- For standard control, "Hysteresis (heating)" is used. "Hysteresis (cooling)" cannot be used.
- For heating/cooling control, the Hysteresis can be set separately for heating and cooling. Use "Hysteresis (heating)" for heating and "Hysteresis (cooling)" for cooling.
- This setting appears when Proportional band = 0.00



| Setting range | Units | Default value |
|---------------|-------|---------------|
| 0.01 to 99.99 | %FS   | 0.10          |



- Related setting data  
"PID\* Proportional band (PID setting level) (P8-31)

|    |                          |             |  |
|----|--------------------------|-------------|--|
| CH | Control period (heating) | <i>[P</i>   | <span style="border: 1px solid black; padding: 2px;">L.Pd</span> |
|    | Control period (cooling) | <i>]-[P</i> |  |



- This sets the output period. When setting this value, take controllability and product life (if the connected manipulation device is a relay) into consideration.
- "Control period (heating)" is used for standard control.
- For heating/cooling control, control periods can be set separately for heating and cooling.



| Setting data             | Setting range | Units | Default value |
|--------------------------|---------------|-------|---------------|
| Control period (heat)    | 0.2 to 99.0   | Sec   | 20.0          |
| Control period (cooling) | 0.2 to 99.0   | Sec   | 20.0          |



- Related setting data  
"PID\* Proportional band (PID setting level) (P8-31)

CH

Position proportional dead band

db

L.Adj

Position proportional control type



- This sets the output hold interval (the interval while switching the open output and close output ON and OFF) during position proportional control.



Setting

| Data range  | Units | Default value |
|-------------|-------|---------------|
| 0.1 to 10.0 | %     | 2.0           |



Reference

- Related setting data  
"Open/Close hysteresis" (Adjustment level) (P.8-17)

CH

Open/Close hysteresis

dc-H

L.Adj

Position proportional control type



- This setting is used to add hysteresis when switching the open output and close output ON and OFF during position proportional control.



Setting

| Data range  | Units | Default value |
|-------------|-------|---------------|
| 0.1 to 20.0 | %     | 0.8           |



Reference

- Related setting data  
Position proportional dead band (Adjustment level) (P.8-17)

|    |                    |                   |      |
|----|--------------------|-------------------|------|
| CH | SP ramp time unit  | SP <sub>r</sub> U | LADJ |
|    | SP ramp rise value | SP <sub>r</sub> H |      |
|    | SP ramp fall value | SP <sub>r</sub> L |      |



- This specifies the change rate during SP ramp. The maximum allowed change per unit of time is set as the "SP ramp rise value" and "SP ramp fall value". When these are set to "0", the SP ramp function is disabled.
- The decimal point position of the SP ramp rise and fall values is determined by the selected sensor during temperature input, and by the scaling during analog input.



| Setting data       | Setting range                             | Units | Default value |
|--------------------|---|-------|---------------|
| SP ramp time unit  | 5: EU/sec, $\bar{n}$ : EU/min, H: EU/hour | –     | EU/min        |
| SP ramp rise value | 0 to 99999(0: OFF)                        | *1    | 0: OFF        |
| SP ramp fall value | 0 to 99999(0: OFF)                        | *1    | 0: OFF        |

\*1 Depends on the SP ramp time unit setting. (The initial setting is EU/min.)



- Related setting data  
 "Input \*type" (Input initial setting level) (P.8-36)  
 "Scaling input value 1", "Scaling display value 1", "Scaling input value 2", "Scaling display value 2", "Decimal point position" (Input initial setting level) (P.8-37)

|    |                |      |      |
|----|----------------|------|------|
| CH | MV at stop     | MV-S | LADJ |
|    | MV at PV error | MV-E |      |



- On a standard type, "Manipulated variable at stop" is set to the MV when operation is stopped. On a position proportional control type, "MV at stop" is set to the position when operation is stopped (Completely open/Hold/Completely closed).
- On a standard type, "MV at PV error" is set to the MV when an error occurs. On a position proportional control type, "MV at stop" is set to the position when an error occurs (Completely open/Hold/Completely closed).



| Control method  | Setting range   | Units | Default value |
|-----------------|-----------------|-------|---------------|
| Standard        | -5.0 to 105.0   | %     | 0.0           |
| Heating/Cooling | -105.0 to 105.0 | %     | 0.0           |

A negative value is set for the cooling MV for heating/cooling control.

- Position proportional control type

| Control method        | Setting range                                      | Units | Default value |
|-----------------------|--|-------|---------------|
| Position proportional | -1: Completely closed, 0: Hold, 1: Completely open | –     | 0: Hold       |



- Related information  
"4.12 Starting and stopping control" (P.4-27)

CH

|                                |      |   |
|--------------------------------|------|---|
| MV change rate limit (heating) | orL  | L.Adj   |
| MV change rate limit (cooling) | corL | Advanced PID control (Proportional band ≠ 0.00) |



- The MV change rate limit sets the maximum allowed change in the MV (or the opening on a position proportional control type) per second. If a change occurs in the MV that exceeds this limit, the MV will be changed at the set rate limit until the required change is attained. When set to "0.0", the function is disabled.
- For standard control, use "MV change rate limit (heating)". "MV change rate limit (cooling)" cannot be used.
- For heating/cooling control, the MV change rate limit can be set separately for heating and cooling. Use "MV change rate limit (heat)" for heating and "MV change rate limit (cooling)" for cooling.
- The MV change rate limit cannot be used in the following situations:
  - Manual mode
  - AT is running
  - During ON/OFF control (P=0.00)
  - During stop (during "Manipulated variable at stop" output)
  - During "MV at PV error" output



| Setting data                   | Setting range | Units | Default value |
|--------------------------------|---------------|-------|---------------|
| MV change rate limit (heat)    | 0.0 to 100.0  | %/sec | 0.0           |
| MV change rate limit (cooling) | 0.0 to 100.0  | %/sec | 0.0           |



- Related setting data  
"PID\* Proportional band" (PID setting level) (P.8-31)  
"MV change rate limit mode" (Expansion control setting level) (P.8-78)

Setting data

CH

Input value 1 for input correction    252.1  
 Input shift 1                            255.1  
 Input value 2 for input correction    252.2  
 Input shift 2                            255.2

LRd

Input shift can be performed at any two points.



These settings are used to set input shift 1 and input shift 2 for any two points (input value 1 for input correction and input value 2 for input correction) (two-point correction).

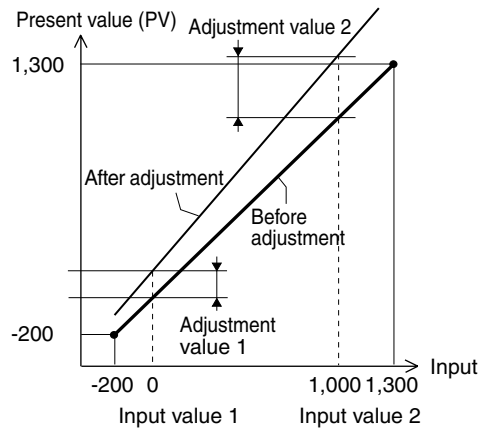

| Setting data                       | Setting range      | Units | Default value |
|------------------------------------|--------------------|-------|---------------|
| Input value 1 for input correction | -19999 to 99999 *1 | EU    | -200.0        |
| Input shift 1                      | -199.99 to 999.99  | EU    | 0.00          |
| Input value 2 for input correction | -19999 to 99999 *1 | EU    | 1300.0        |
| Input shift 2                      | -199.99 to 999.99  | EU    | 0.00          |

\*1 The decimal point position will vary depending on the input type.  
 \*2 If the input type is changed, the default values of the input value for input calibration will change to the upper and lower-limits of the input range of the sensor type being used.



● Related setting data  
 "Input \* type" (Input initial setting level) (P.8-36)

CH

|                                |      |       |
|--------------------------------|------|-------|
| Disturbance gain               | dōn  | L.Adj |
| Disturbance time constant      | dōt  |       |
| Disturbance rectification band | dō-b |       |
| Disturbance judgment width     | dōy  |       |

These settings are used to adjust overshoot to disturbances.



- Disturbance gain is used to adjust the amount of overshoot caused by disturbances.



| Setting data                   | Setting range   | Units | Default value |
|--------------------------------|-----------------|-------|---------------|
| Disturbance gain               | -1.00 to 1.00   | –     | 0.65          |
| Disturbance time constant      | 0.01 to 99.99   | –     | 1.00          |
| Disturbance rectification band | 0.000 to 9.999  | %FS   | 0.000         |
| Disturbance judgment width     | -99.99 to 99.99 | %FS   | 0.00          |



- Related setting data  
"Disturbance overshoot adjustment function" (Expansion control setting level) (P.8-80)



## 8.5 Adjustment 2 level (LAd2)

Adjustment level 2 contains supplemental settings for adjustment of control such as the time constant of first order lag operation, move average count, low-cut point of extraction of square root operations, and settings for proportional control. These functions only appear in the display if they are enabled in Control initial setting 2 level.

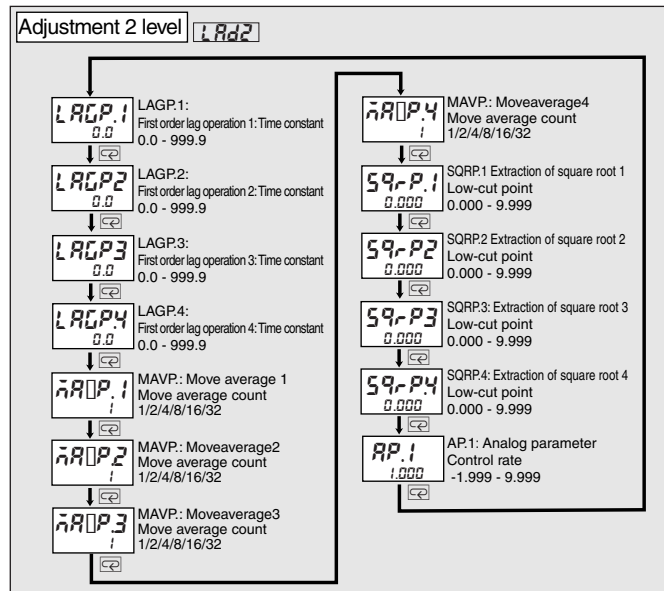
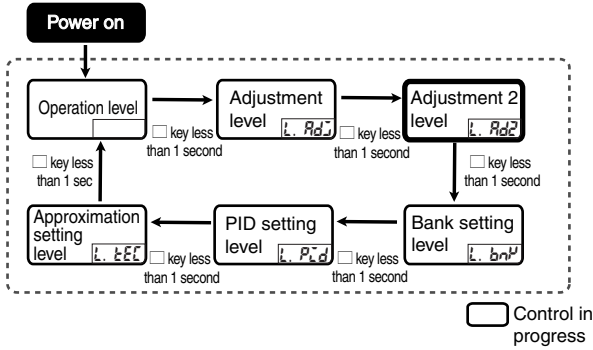

|  |        |   |
|--|--------|---|
| First order lag operation 1: Time constant | LAGP.1 | LAd2  |
| First order lag operation 2: Time constant | LAGP.2 |   |
| First order lag operation 3: Time constant | LAGP.3 |   |
| First order lag operation 4: Time constant | LAGP.4 | First order lag operation * function is enabled |



- These settings are used to set the time constant of the first order filter of each input. Data after the first order lag filter elapses is shown below.
- The filter is used to filter out noise elements in the input.

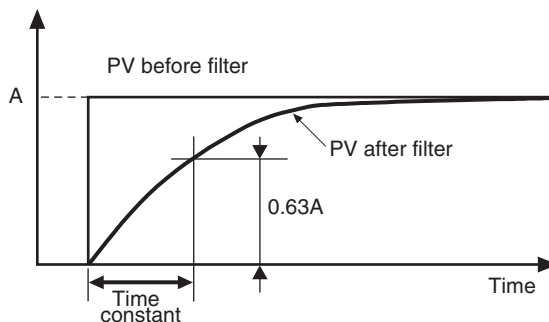

Setting

| Setting range | Units | Default value |
|---------------|-------|---------------|
| 0.0 to 999.9  | Sec   | 0.0           |



Reference

- Related information  
"5.1 Input adjustment functions ■ First order lag operation" (P.5-5)
- Related setting data  
"First order lag operation \* Enable" (Control initial setting 2 level) (P.8-50)

|                |                    |        |                                    |
|----------------|--------------------|--------|------------------------------------|
| Move average 1 | Move average count | ̄RdP.1 | L.Ad2                              |
| Move average 2 | Move average count | ̄RdP.2 |                                    |
| Move average 3 | Move average count | ̄RdP.3 |                                    |
| Move average 4 | Move average count | ̄RdP.4 | Move average * function is enabled |



Function

- These settings set the move average count for move averaging for each input. Data following the move average is shown below.

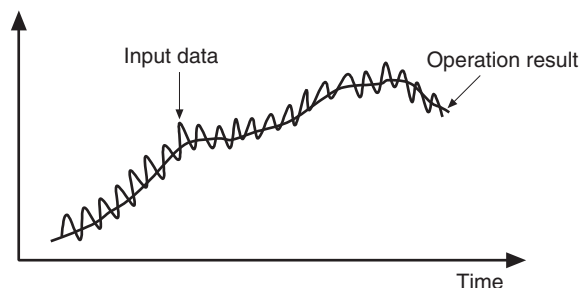

- This function is used to reduce changes in the input due to disturbances in the fluid surface when controlling fluid level.



Setting

| Setting range | Units           | Default value |
|---------------|-----------------|---------------|
| 1,2,4,8,16,32 | Number of times | 1             |

Setting data



- Related information  
"5.1 Input adjustment functions ■ Move average" (P.5-5)
- Related setting data  
"Move average \* Enable" (Control initial setting 2 level) (P.8-50)

---

|   |               |                             |
|---|---------------|-----------------------------|
| Extraction of square root 1 Low-cut point | <i>59-P.1</i> | <i>L.Pd2</i>                |
| Extraction of square root 2 Low-cut point | <i>59-P.2</i> |                             |
| Extraction of square root 3 Low-cut point | <i>59-P.3</i> | Extraction of square root * |
| Extraction of square root 4 Low-cut point | <i>59-P.4</i> | function is enabled         |

---



- These settings are used to set the low-cut point of each input. Data following extraction of square root operations are shown below.
- This function is used for extraction of square root operations for fluid sensors.

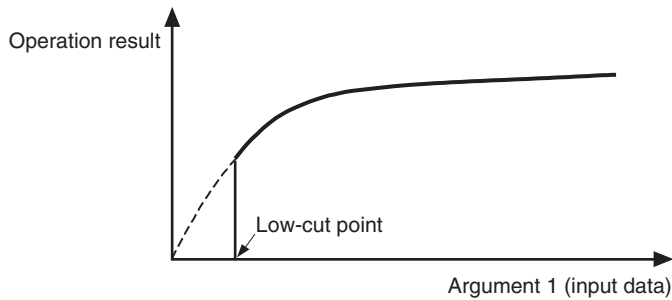

| Setting range  | Units | Default value |
|----------------|-------|---------------|
| 0.000 to 9.999 | -     | 0.000         |



- Related information  
"5.1 Input adjustment functions ■ Extraction of square root operations" (P.5-7)
- Related setting data  
"Extraction of square root \* Enable" (Control initial setting 2 level) (P.8-51)

Analog parameter 1

AP.1

L.Rd2

Proportional control



This sets the proportion used for proportional control.



Setting

| Setting range   | Units | Default value |
|-----------------|-------|---------------|
| -1.999 to 9.999 | -     | 1.000         |



Reference

- Related information  
"3.5 Ratio control of dyeing machines" (P.3-18)
- Related setting data  
"Control mode" (Control initial setting level) (P.8-43)

## 8.6 Bank setting level (L.bank)

This level includes SP, PID set, and alarm settings for each bank. To move to a bank, use "Display bank selection" which appears at the beginning of Bank setting level.

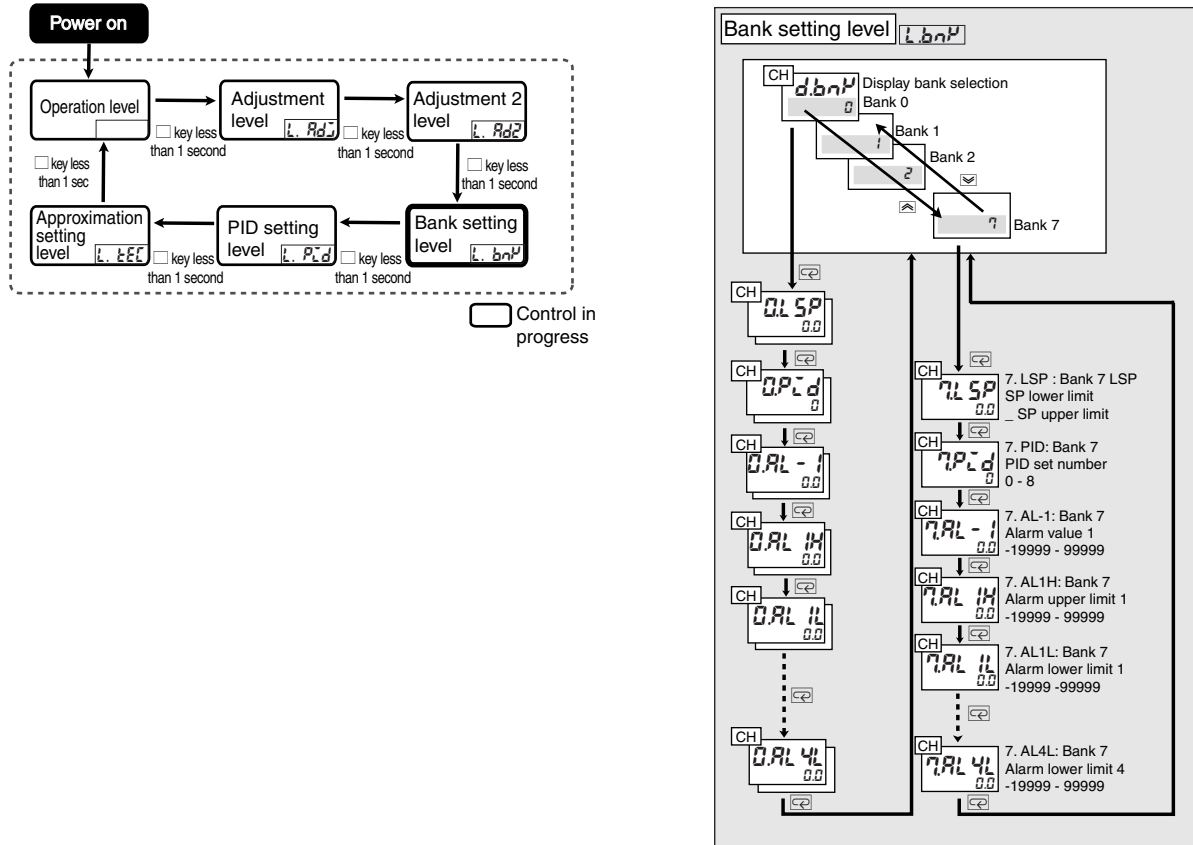

|    |                        |        |        |
|----|------------------------|--------|--------|
| CH | Display bank selection | d.bank | L.bank |
|----|------------------------|--------|--------|

Use this setting to select the bank that you wish to display.



Function

- Set the number of the bank that you wish to display.
- Up to 8 banks (Bank Nos. 0 to 7) can be used. An SP (local SP), alarm value, and PID Set No. are stored in each bank.



Setting

| Setting data           | Setting range | Units | Default value |
|------------------------|---------------|-------|---------------|
| Display bank selection | 0 to 7        | -     | 0             |

\* Bank number selected for execution.



Reference

- Related setting data  
"Bank No." (Adjustment level) (P.8-13)

CH

Bank \* local SP (LSP)

\* *LSP*

L.bank

(\*: 0 to 7)

Use this setting to set the SP (local SP) in each bank.



- The SP of banks 0 to 7 can be set.
- When an SP is changed in "PV/SP" in Operation level, the local SP of the currently used bank is also changed.



| Setting data | Setting range                       | Units | Default value |
|--------------|-------------------------------------|-------|---------------|
| Local SP     | SP lower limit to<br>SP upper limit | EU    | 0             |



- Related information  
"5.2 Control functions ■ Banks" (P.5-9)
- Related setting data  
"PV/SP" (Operation level) (P.8-7)

CH

Bank \* PID Set No.

\* *Pid*

L.bank

(\*: 0 to 7)

Use this setting to store a PID Set No. in each bank.



- The PID Set No. of banks 0 to 7 can be stored.
- When the PID Set No. is set to "0", the PID set auto select function automatically selects a PID set based on the PV or DV (deviation). If you wish to specify a PID set, set the number of the PID set (1 to 8).



| Setting data | Setting range | Units | Default value |
|--------------|---------------|-------|---------------|
| PID Set No.  | 0 to 8        | -     | 0             |



- Related information  
"5.2 Control functions ■ Banks" (P.5-9)  
"5.2 Control functions ■ PID sets" (P.5-12)
- Related setting data  
"PID\* proportional band", "PID\* Integral time", "PID\* derivative time" (PID setting level) (P.8-31)  
"PID\* Automatic selection range upper limit" (PID setting level) (P.8-32)  
"PID set automatic selection data" (Expansion control setting level) (P.8-74)

CH

Bank \* alarm 1 \* *AL - 1*

*Lbnd*

Bank \* alarm 2 \* *AL - 2*

Bank \* alarm 3 \* *AL - 3*

Bank \* alarm 4 \* *AL - 4*

(\*: 0 to 7)

Alarm function is enabled

Use this setting to store alarm values for alarms 1 to 4 in each bank.



- Set the values of alarms 1 to 4 in each of banks 0 to 7.



Setting

| Setting range   | Units | Default value |
|-----------------|-------|---------------|
| -19999 to 99999 | EU    | 0             |



Reference

This setting can be used when the alarm type is other than "none", "Upper- and lower-limit alarm", "Upper- and lower-limit range alarm", or "Upper- and lower-limit alarm with standby sequence".

● Related setting data

- "Alarm \* type" (Alarm setting level) (P.8-54)
- "Alarm \* latch" (Alarm setting level) (P.8-55)
- "Alarm \* hysteresis" (Alarm setting level) (P.8-56)
- "Standby sequence restart" (Alarm setting level) (P.8-57)
- "Auxiliary output \* non-exciting" (Alarm setting level)(P.8-58)

CH

|                            |                |                            |                |  |
|----------------------------|----------------|----------------------------|----------------|--|
| Bank * alarm upper limit 1 | * <i>AL 1H</i> | Bank * alarm lower limit 1 | * <i>AL 1L</i> | <b>L.brV</b><br>Alarm * type is upper- and lower-limit alarm |
| Bank * alarm upper limit 2 | * <i>AL 2H</i> | Bank * alarm lower limit 2 | * <i>AL 2L</i> |  |
| Bank * alarm upper limit 3 | * <i>AL 3H</i> | Bank * alarm lower limit 3 | * <i>AL 3L</i> |  |
| Bank * alarm upper limit 4 | * <i>AL 4H</i> | Bank * alarm lower limit 4 | * <i>AL 4L</i> |  |

(\*: 0 to 7)

If an alarm mode with upper- and lower-limit settings is selected for "Alarm 1 type" through "Alarm 4 type", the upper limit and lower limit are set separately.



- Set the upper and lower-limits of alarms 1 to 4 in banks 0 to 7.
- For temperature input, the decimal point position will depend on the selected sensor. For analog input, the position is set using the "Decimal point position" setting.



| Setting range   | Units | Default value |
|-----------------|-------|---------------|
| -19999 to 99999 | EU    | 0             |



This setting can be used when the alarm type is "Upper- and lower-limit alarm", "Upper- and lower-limit range alarm", or "Upper- and lower-limit alarm with standby sequence".

● Related setting data

- "Alarm \* type" (Alarm setting level) (P.8-54)
- "Alarm \* latch" (Alarm setting level) (P.8-55)
- "Alarm \* hysteresis" (Alarm setting level) (P.8-56)
- "Standby sequence restart" (Alarm setting level) (P.8-57)
- "Auxiliary output \* non-exciting" (Alarm setting level) (P.8-58)



## 8.7 PID setting level (L.Pid)

This level contains the PID value, MV limit, and alarm settings for each PID set. To move to a PID set, use the "Display PID set select" setting at the beginning of PID setting level.

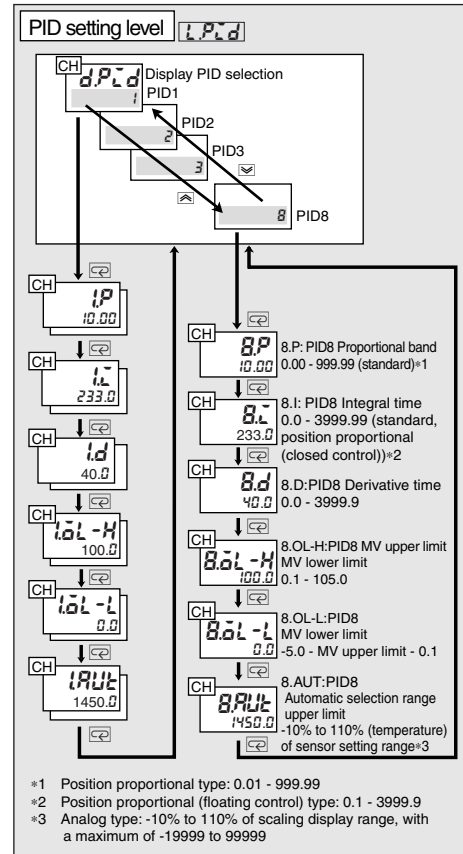
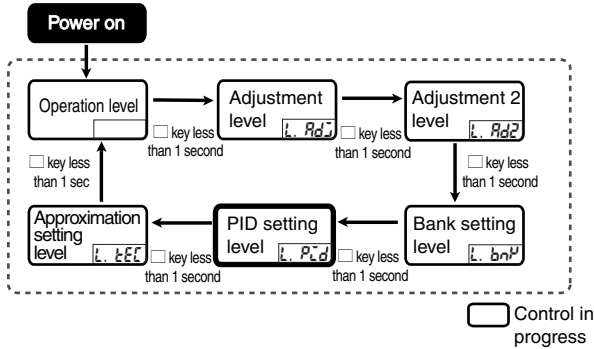

|    |                       |              |       |
|----|-----------------------|--------------|-------|
| CH | Display PID selection | <i>d.Pid</i> | L.Pid |
|----|-----------------------|--------------|-------|

Use this setting to select the PID set that you wish to display.



- Set the number of the PID set that you wish to display.
- Up to 8 PID sets (PID Set Nos. 1 to 8) can be used. PID values, MV upper and lower limits, and automatic selection range upper limit are stored in each PID set.



| Setting data          | Setting range | Units | Default value |
|-----------------------|---------------|-------|---------------|
| Display PID selection | 1 to 8        | —     | *             |

\* Selected PID set



- Related setting data  
"Bank No." (Adjustment level) (P.8-13)

CH

PID\* Proportional band \* P

L.Pid

PID\* Integral time \* I

PID\* Derivative time \* d

(\*: 1 to 8)

Advanced PID control

These settings are used to store PID values in each PID set. If AT is run, the values are set automatically.



P action: Control action using an MV proportional to the deviation.

I action: Control action using output that is proportional to the time integral of the deviation. P action causes an offset, and thus it is used in combination with I action. As time elapses the offset disappears and the controlled temperature and SP equalize.

D action: Control action using output that is proportional to the time derivative of the input. P action and I action serve to correct the control result and thus respond slowly to sudden temperature changes. D action corrects control by adding an MV that is proportional to the slope of the temperature change.



| Setting data          | Setting range  | Units | Default value |
|-----------------------|----------------|-------|---------------|
| Proportional band (P) | 0.00 to 999.99 | %FS   | 10.00         |
| Integral time (I)     | 0.0 to 3999.9  | Sec   | 233.0         |
| Derivative time (D)   | 0.0 to 3999.9  | Sec   | 40.0          |

- For ON/OFF control, set the proportional band to "0.0". "0.0" cannot be selected on a position proportional type.
- For P control or PD control, set the integral time to "0.0". "0.0" cannot be selected on a position proportional type when performing floating control or when "Operation at potentiometer error" is set to "Continue".



- Related setting data  
"AT Execute/Cancel" (Adjustment level) (P.8-13)

CH

PID\* MV upper limit \* UL-H

L.Pid

PID\* MV lower limit \* UL-L

(\*: 1 to 8)

Advanced PID control



- Use "MV upper limit" and "MV lower limit" to set upper- and lower-limits for the MV. When the unit calculates an MV that is outside of the upper and lower limits, the upper or lower-limit is output.

- MV upper limit  
The setting range differs for standard control and heating/cooling control.  
The cooling MV of heating/cooling control is expressed as a negative value.

- MV lower limit  
The setting range differs for standard control and heating/cooling control.  
The cooling MV of heating/cooling control is expressed as a negative value.
- The MV limit function does not operate on a position proportional type during floating control, and thus the setting is not effective in this case.



Setting

| Setting data   | Setting range                                      | Units | Default value |
|----------------|--|-------|---------------|
| MV upper limit | Standard control:<br>MV lower limit + 0.1 to 105.0 | %     | 100.0         |
|                | Heating/cooling control:<br>0.0 to 105.0           | %     | 100.0         |
| MV lower limit | Standard control:<br>-5.0 to MV upper limit - 0.1  | %     | 0.0           |
|                | Heating/cooling control:<br>-105.0 to 0.0          | %     | 0.0           |

The following MVs take precedence over the MV limits:

- Manual MV
- Manipulated variable at stop
- MV at PV error



Reference

- Related information  
"5.3 Output adjustment functions ■ MV limit" (P.5-16)

CH

PID\* Automatic selection range upper limit

\* *Aut*

*LPid*

(\*: 1 to 8)

When using automatic selection of PID sets, use this setting to set an upper limit for each PID set.



Function

- Set the automatic selection range upper limit for PID Set Nos. 1 to 8.
- Note that the limit for PID Set 8 is fixed at 110% of the sensor setting range, and thus does not need to be set.
- This value is applied to the PV (present value) or DV (deviation) set in "PID set automatic selection data". The initial setting is "PV".



Setting

| Setting data                          | Setting range   | Units | Default value |
|---------------------------------------|-----------------|-------|---------------|
| Automatic selection range upper limit | -19999 to 99999 | EU    | 1450.0        |



Reference

- Related information  
"5.2 Control functions ■ Banks" (P.5-9)  
"5.2 Control functions ■ PID sets" (P.5-12)
- Related setting data  
"PID set automatic selection data" (Expansion control setting level) (P.8-74)

# 8.8 Approximation setting level (L.E.E.C)

This level contains straight-line and broken-line approximation settings. These settings only appear if enabled in Control initial setting 2 level.

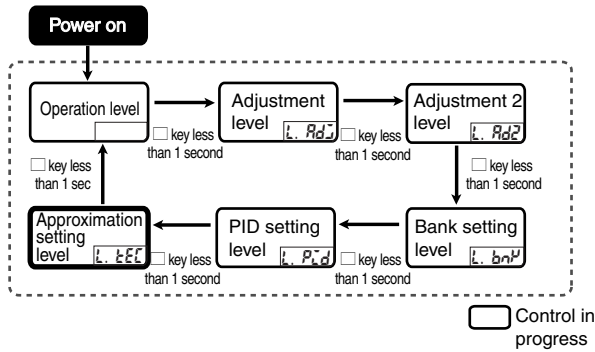

Approximation setting level L.E.E.C

|                 |  |                 |  |
|-----------------|--|-----------------|--|
| SC 1.1<br>0.000 | SI1.1: Straight-line approximation 1<br>Input 1<br>-1.999 - 9.999  | FO1.1<br>0.000  | FI01.1: Broken-line approximation 1<br>Input 1<br>-1.999 - 9.999   |
| SC 2.1<br>1.000 | SI2.1: Straight-line approximation 1<br>Input 2<br>-1.999 - 9.999  | FO20.1<br>0.000 | FI20.1: Broken-line approximation 1<br>Input 20<br>-1.999 - 9.999  |
| SO 1.1<br>0.000 | SO1.1: Straight-line approximation 1<br>Output 1<br>-1.999 - 9.999 | FO01.1<br>0.000 | FO01.1: Broken-line approximation 1<br>Output 1<br>-1.999 - 9.999  |
| SO 2.1<br>1.000 | SO2.1: Straight-line approximation 1<br>Output 2<br>-1.999 - 9.999 | FO20.1<br>0.000 | FO20.1: Broken-line approximation 1<br>Output 20<br>-1.999 - 9.999 |
| SC 1.2<br>0.000 | SI1.2: Straight-line approximation 2<br>Input 1<br>-1.999 - 9.999  |                 |  |
| SC 2.2<br>1.000 | SI2.2: Straight-line approximation 2<br>Input 2<br>-1.999 - 9.999  |                 |  |
| SO 1.2<br>0.000 | SO1.2: Straight-line approximation 2<br>Output 1<br>-1.999 - 9.999 |                 |  |
| SO 2.2<br>1.000 | SO2.2: Straight-line approximation 2<br>Output 2<br>-1.999 - 9.999 |                 |  |

- Straight-line approximation \* Input 1      SC 1. \*
  - Straight-line approximation \* Input 2      SC 2. \*
  - Straight-line approximation \* Output 1      SO 1. \*
  - Straight-line approximation \* Output 2      SO 2. \*
- (\*: 1 or 2)

L.E.E.C

Straight-line approximation \* is enabled

Use these settings to configure straight-line approximation 1 and 2.



- Set values for straight-line approximation. Specify two points: straight-line approximations 1 and 2. Use normalized data for the values.
- If Input 1 = Input 2, the setting will not be effective and will be regarded as straight-line approximation with input data = output data.

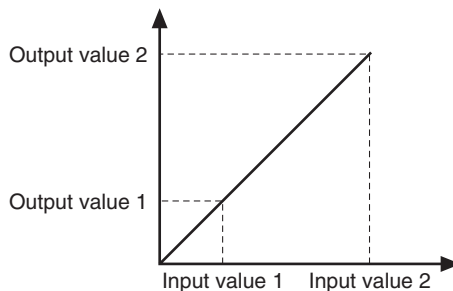

Setting data



Setting

| Setting data                           | Setting range   | Units | Default value |
|--|-----------------|-------|---------------|
| Straight-line approximation * Input 1  | -1.999 to 9.999 | —     | 0.000         |
| Straight-line approximation * Input 2  | -1.999 to 9.999 | —     | 1.000         |
| Straight-line approximation * Output 1 | -1.999 to 9.999 | —     | 0.000         |
| Straight-line approximation * Output 2 | -1.999 to 9.999 | —     | 1.000         |



Reference

- Related setting data  
"Straight-line approximation 1 enable", "Straight-line approximation 2 enable" (Control initial setting 2 level) (P.8-51)

Broken-line approximation 1 Input 1 to **F<sub>20</sub> 1.1 to F<sub>20</sub> 2.1** L.t.E.C  
 Broken-line approximation 1 Input 20  
 Broken-line approximation 1 Output 1 to **F<sub>20</sub> 1.1 to F<sub>20</sub> 2.1**  
 Broken-line approximation 1 Output 20 Broken-line approximation \* is enabled

Use these settings to set values for broken-line approximation 1.



Function

- Set values for broken-line approximation. Up to 20 points can be specified for one broken line approximation. Use normalized data for the values.
- If Input n ≥ Input n + 1, the setting of point "n + 1" will not be effective.

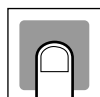
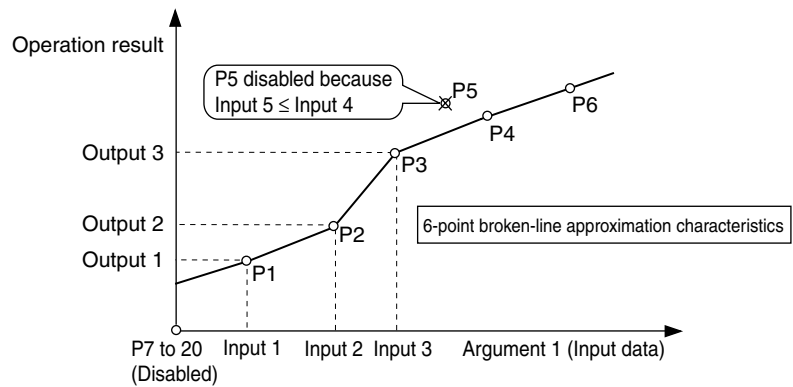

Setting

| Setting data   | Setting range   | Units | Default value |
|--|-----------------|-------|---------------|
| Broken-line approximation * Input 1 to<br>Broken-line approximation * Input 20   | -1.999 to 9.999 | —     | 0.000         |
| Broken-line approximation * Output 1 to<br>Broken-line approximation * Output 20 | -1.999 to 9.999 | —     | 0.000         |



Reference

- Related information  
"5.1 Input adjustment functions ■ Broken-line approximation" (P.5-6)
- Related setting data  
"Broken-line approximation 1 enable" (Control initial setting 2 level) (P.8-51)

# 8.9 Input initial setting level (L.0)

This level contains initial settings for input, including input type, temperature units, and scaling settings.

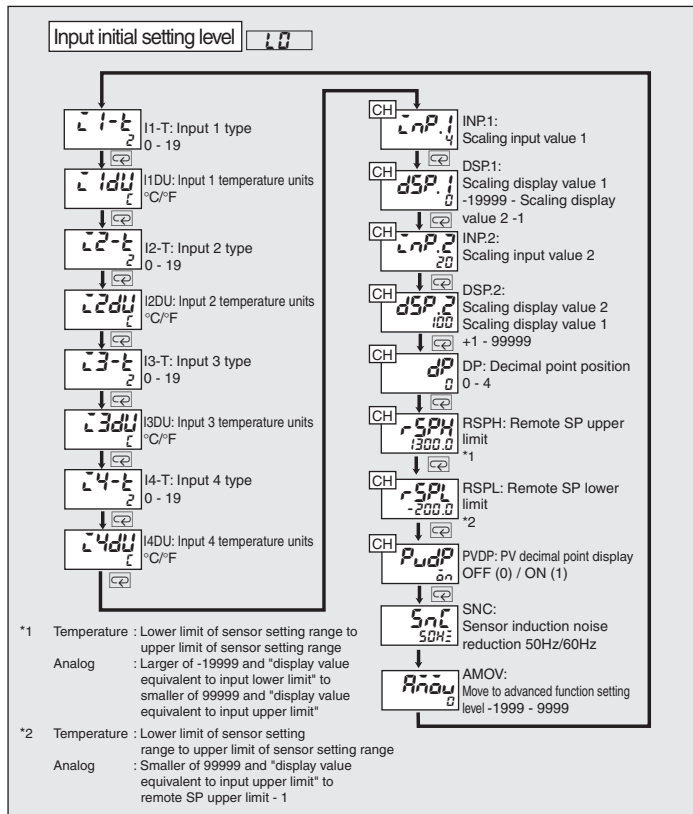
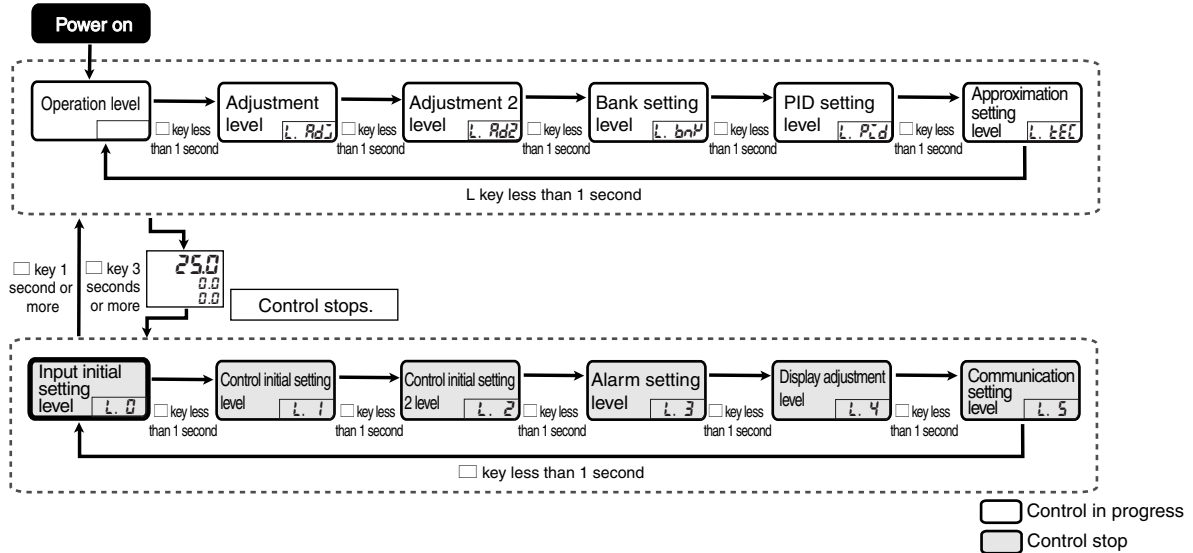

Setting data

|                    |      |    |
|--------------------|------|----|
| Input 1 input type | ┌1-┐ | L0 |
| Input 2 input type | ┌2-┐ |    |
| Input 3 input type | ┌3-┐ |    |
| Input 4 input type | ┌4-┐ |    |



- These settings are used to set the sensor type.
- If these settings are changed, the SP limit settings are returned to the initial settings. In this case, reset the "SP upper limit" and "SP lower limit" settings as necessary.
- Refer to the following table to configure the settings. Initial settings are shaded.



| Setting value | Input type | Setting range   |                   | Input type switch |
|---------------|------------|---|-------------------|-------------------|
|               |            | (°C)  | (°F)              |                   |
| 0             | Pt100(1)   | -200.0 to 850.0   | -300.0 to 1500.0  | TC.PT<br>         |
| 1             | Pt100(2)   | -150.00 to 150.00   | -199.99 to 300.00 |                   |
| 2             | K(1)       | -200.0 to 1300.0  | -300.0 to 2300.0  |                   |
| 3             | K(2)       | -20.0 to 500.0  | 0.0 to 900.0      |                   |
| 4             | J(1)       | -100.0 to 850.0   | -100.0 to 1500.0  |                   |
| 5             | J(2)       | -20.0 to 400.0  | 0.0 to 750.0      |                   |
| 6             | T          | -200.0 to 400.0   | -300.0 to 700.0   |                   |
| 7             | E          | 0.0 to 600.0  | 0.0 to 1100.0     |                   |
| 8             | L          | -100.0 to 850.0   | -100.0 to 1500.0  |                   |
| 9             | U          | -200.0 to 400.0   | -300.0 to 700.0   |                   |
| 10            | N          | -200.0 to 1300.0  | -300.0 to 2300.0  |                   |
| 11            | R          | 0.0 to 1700.0   | 0.0 to 3000.0     |                   |
| 12            | S          | 0.0 to 1700.0   | 0.0 to 3000.0     |                   |
| 13            | B          | 100.0 to 1800.0   | 300.0 to 3200.0   |                   |
| 14            | W          | 0.0 to 2300.0   | 0.0 to 4100.0     |                   |
| 15            | 4 to 20 mA | Depends on scaling<br>One of the following ranges appears<br>depending on the scaling:<br>-19999 to 99999<br>-1999.9 to 9999.9<br>-199.99 to 999.99<br>-19.999 to 99.999<br>-1.9999 to 9.9999 |                   | ANALOG<br>        |
| 16            | 0 to 20 mA |   |                   |                   |
| 17            | 1 to 5V    |   |                   |                   |
| 18            | 0 to 5V    |   |                   |                   |
| 19            | 0 to 10V   |   |                   |                   |

Set the input type switch of each input to match the "Input type" setting of the corresponding input.

The initial setting is "2". ("TC.PT")



- Related setting data  
 "Input \* temperature units" (Input initial setting level) (P.8-37)  
 "SP upper limit", "SP lower limit" (Control initial setting level) (P.8-43)

|                           |      |                                 |
|---------------------------|------|---------------------------------|
| Input 1 temperature units | L1dU | L0                              |
| Input 2 temperature units | L2dU |                                 |
| Input 3 temperature units | L3dU |                                 |
| Input 4 temperature units | L4dU | Input type is temperature input |



- Select Celsius (°C) or Fahrenheit (°F) for the temperature units.



| Setting range | Units | Default value |
|---------------|-------|---------------|
| E: °C         | -     | E: °C         |
| F: °F         |       |               |



- Related setting data  
"Input \* Type" (Input initial setting level) (P.8-36)

|                         |       |                            |
|-------------------------|-------|----------------------------|
| Scaling input value 1   | LnP.1 | L0                         |
| Scaling display value 1 | dSP.1 |                            |
| Scaling input value 2   | LnP.2 |                            |
| Scaling display value 2 | dSP.2 |                            |
| Decimal point position  | dP    | Input type is analog input |



- These settings are used when the input type is analog input.
- Scaling is carried out for analog input. The display value for "Scaling input value 1" is set in "Scaling display value 1", and the display value for "Scaling input value 2" is set in "Scaling display value 2".
- "Decimal point position" is used to specify the decimal point position of setting data (SP, etc.) for which the units are "EU".
- Scaling settings for inputs 2 to 4 of multi-point input types are set in channels 2 to 4. Press the **CH** key to change to the desired analog input channel and then set the scaling.



| Setting data            | Setting range                          | Units | Default value |
|-------------------------|--|-------|---------------|
| Scaling input value 1   | Input lower limit to input upper limit | *     | 4             |
| Scaling display value 1 | -19999 to Scaling upper limit - 1      | EU    | 0             |
| Scaling input value 2   | Input lower limit to input upper limit | *     | 20            |
| Scaling display value 2 | Scaling lower limit + 1 to 99999       | EU    | 100           |
| Decimal point position  | 0 to 4                                 | -     | 0             |

\* The units depend on the input type settings.



- Related setting data  
"Input \* type" (Input initial setting level) (P.8-36)





The operation of E5AR/ER control functions and alarms is based on the input values. If a value greater than "LnP.2: Scaling input value 2" is set for "LnP.1: Scaling input value 1," operation will work in the opposite direction of the display values. The user must confirm compatibility with devices. For details, refer to "4.4 Setting the input type" (P.4-8).

|                       |      |                         |
|-----------------------|------|-------------------------|
| Remote SP upper limit | rSPH | LD                      |
| Remote SP lower limit | rSPL | Control with remote SP* |



- This sets the upper- and lower-limit of remote SP. The remote SP upper limit is set with respect to the upper input range limit of input 2, and the remote SP lower limit is set with respect to the lower input range limit of input 2. For example, if the input 2 type is 4 to 20 mA, the remote SP upper limit is set with respect to 20 mA and the remote SP lower limit is set with respect to 4 mA.
- If the input type, temperature units, and scaling of input 1 are changed, the settings are changed to the upper and lower limits of the sensor.
- The decimal point position depends on the selected sensor. For analog input, the decimal point position depends on the "Decimal point position" setting.

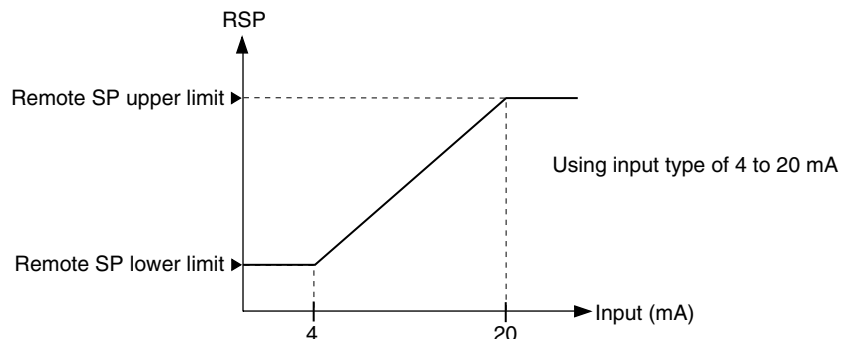

Note that the SP limits are in effect, and therefore if the input remote SP is above or below the SP limits, the SP will be clamped to the upper or lower limit.

\* During cascade control only Ch2 is displayed.



| Setting data          | Setting range   | Units | Default value |
|-----------------------|---|-------|---------------|
| Remote SP upper limit | Temperature:<br>Lower limit of sensor setting range to upper limit of sensor setting range<br>Analog:<br>Smaller of 99999 and "display value equivalent to upper input limit" to smaller of 99999 and "display value equivalent to upper input limit" | EU    | 1300.0        |

| Setting data          | Setting range   | Units | Default value |
|-----------------------|---|-------|---------------|
| Remote SP lower limit | Temperature:<br>Lower limit of sensor setting range to upper limit of sensor setting range<br>Analog:<br>Larger of -19999 and "display value equivalent to input lower limit" to smaller of 99999 and "display value equivalent to upper input limit" | EU    | -200.0        |



● Related setting data

"Input \* type" (Input initial setting level) (P.8-36)

"Input \* temperature units" (Input initial setting level) (P.8-37)

"Control mode" (Control initial setting level) (P.8-43)

"SP upper limit", "SP lower limit" (Control initial setting level) (P.8-43)

Note: When the input type of remote SP input is set to temperature input, be sure to set the input type of the main input to the same setting as the input type of remote SP input.

If the input type of remote SP input is set to temperature input and the upper and lower limits of remote SP are not the same as the upper and lower limits of the sensor setting range of the input type of remote SP input, it will not be possible to obtain a correct remote SP value.

CH

PV decimal point display

*P<sub>udP</sub>*

L.D

Temperature input

This setting can be used to not show the digits of the PV after the decimal point.



- When "PV decimal point display" is turned OFF, the digits of the PV after the decimal point are not shown. When turned ON, the digits after the decimal point are shown according to the input type setting.



| Setting range | Units | Default value |
|---------------|-------|---------------|
| ōFF : OFF     | -     | ōn : ON       |
| ōn : ON       |       |               |



● Related data

"Input \* type" (Input initial setting level) (P.8-36)

Sensor induction noise reduction

5nE

LD

This function reduces induction noise from the power source in the input.



- This reduces induction noise in the input according to the frequency of the power source.
- Select 50 Hz or 60 Hz as appropriate for the power source used for the controller.



| Setting range              | Units | Default value |
|----------------------------|-------|---------------|
| 50Hz: 50 Hz<br>60Hz: 60 Hz | -     | 50Hz: 50 Hz   |



- Related data  
"Input \* type" (Input initial setting level) (P.8-36)

Move to advanced function setting level

Pñõw

LD

"Initial setting protect" is set to "0"

This function is used to move to Advanced function setting level.



- Enter a password to move to Advanced function setting level.
- The password is set to "-169". After entering "-169", press the  key or wait two seconds and you will move to Advanced function setting level.



| Setting range | Units | Default value |
|---------------|-------|---------------|
| -1999 to 9999 | -     | 0             |



- Related setting data  
"Initial setting protect (Protect level) (P.8-3)

## 8.10 Control initial setting level (L. I)

This level contains initial settings for control such as the control method, as well as the output type, SP limit, control mode, direct/reverse action, and closed/floating settings.

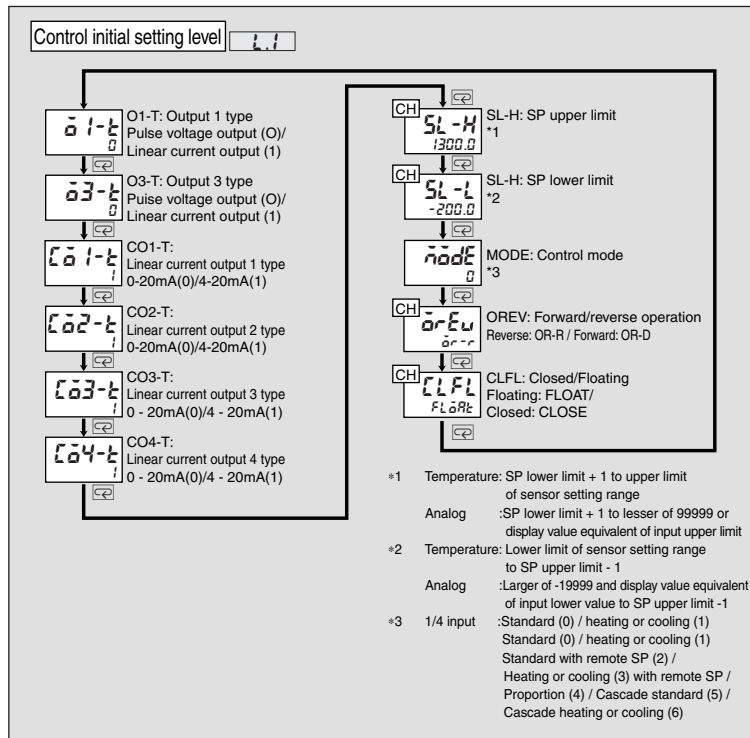
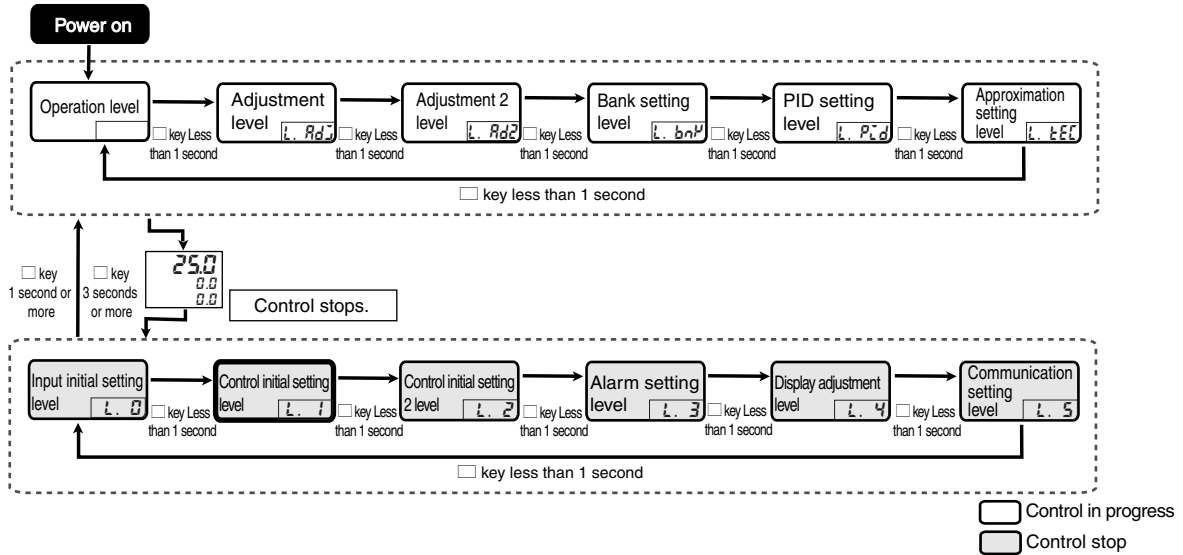

|               |      |                    |
|---------------|------|--------------------|
| Output 1 type | 01-t | L.1                |
| Output 3 type | 03-t | Multi-output model |

Use these settings to select the output type for multi-output.



- Select pulse voltage output or linear current output.
- When pulse voltage output is selected, the output is 12 V DC, 40 mA.
- When linear current output is selected, use the "Linear current output type" setting to select an output of 0 to 20 mA or 4 to 20 mA.



| Setting data | Setting range                                       | Units | Default value |
|--------------|---|-------|---------------|
| Output type  | 0: Pulse voltage output<br>1: Linear current output | -     | 0             |



- Related setting data  
"Linear current output \* type" (Control initial setting level) (P.8-42)  
"Control/Transfer output \* assignment" (Control initial setting 2 level) (P.8-46)

|                                |      |                          |
|--------------------------------|------|--------------------------|
| Linear current output * 1 type | 01-t | L.1                      |
| Linear current output * 2 type | 02-t |                          |
| Linear current output * 3 type | 03-t |                          |
| Linear current output * 4 type | 04-t | Output is current output |

Use this setting to select the linear current output type.



- Select 0 to 20 mA output or 4 to 20 mA output.



| Setting data | Setting range                  | Units | Default value |
|--------------|--------------------------------|-------|---------------|
| Output type  | 0: 0 to 20 mA<br>1: 4 to 20 mA | -     | 1             |



- Related setting data  
"Control/Transfer output \* assignment" (Control initial setting 2 level) (P.8-46)

CH

SP upper limit

SL-H

L.I

SP lower limit

SL-L



- Use this setting to set upper and limits for the SP setting. The SP can only be set between these limits. Note that if the limits are changed and a previously set SP falls outside of the limits due to the change, the SP will automatically change to the upper or lower limit.
- If the input type and temperature units are changed, the settings will change to the upper and lower limits of the sensor.
- The decimal point position depends on the selected sensor. In the case of analog input, the decimal point position is determined by the "Decimal point position" setting.



| Setting data   | Setting range   | Units | Default value |
|----------------|---|-------|---------------|
| SP upper limit | Temperature: SP lower limit + 1 to upper limit of input range<br>Analog: SP lower limit + 1 to smaller of "99999" and "display value equivalent of input upper limit" | EU    | 1300.0        |
| SP lower limit | Temperature: Lower limit of input range to SP upper limit - 1<br>Analog: Larger of "-19999" and "display value equivalent of input lower limit" to SP upper limit - 1 | EU    | -200.0        |



- Related setting data  
"Input \* type" (Input initial setting level) (P.8-36)  
"Input \* temperature units" (Input initial setting level) (P.8-37)

Control mode

nādE

L.I

Use this setting to select the control mode.



- On single-input or 4-input types, select standard control or heating/cooling control.
- On two-input types, select standard control, heating/cooling control, standard control with remote SP, heating/cooling control with remote SP, proportional control, cascade standard control, or cascade heating/cooling control.



Setting

| Setting range  | Units | Default value |
|--|-------|---------------|
| 0: Standard<br>1: Heating/cooling<br>2: Remote SP standard<br>3: Remote SP heating/cooling<br>4: Proportional<br>5: Cascade standard<br>6: Cascade heating/cooling | –     | 0             |

The setting range is 0 to 1 on a single- or 4-input type, or 0 to 6 on a 2-input type.



Reference

- Related information  
"Section 3 Typical Control Examples" (P. 3-1)  
"4.6 Selecting the control mode" (P.4-13)
- Related setting data  
"Manual reset value" (Adjustment level) (P.8-15)  
"Hysteresis (heat)", "Hysteresis (cool)" (Adjustment level) (P.8-16)  
"Control/Transfer output \* assignment" (Control initial setting 2 level) (P.8-46)

CH

Forward/reverse operation

*ǎrÉu*

*L.1*



Function

- When direct action is selected, the MV is increased when the PV increases. When reverse action is selected, the MV is increased when the PV decreases.



Setting

| Setting range   | Units | Default value                |
|---|-------|------------------------------|
| <i>ǎr-r</i> : Reverse operation<br><i>ǎr-d</i> : Direct operation | –     | <i>ǎr-r</i> : Reverse action |



Reference

- Related information  
"4.7 Setting output parameters ■ Direct operation (cool) / Reverse operation (heat)" (P.4-14)

CH

Closed/Floating

*CLFL*

*L.1*

Position proportional type



Function

- Use this setting to select the control method for a position proportional type.



Setting

| Setting range                                    | Units | Default value           |
|--|-------|-------------------------|
| <i>FLǎRE</i> : Floating<br><i>CLǎSE</i> : Closed | –     | <i>FLǎRE</i> : Floating |



Reference

- Related information  
"3.3 Position proportional control of a ceramic kiln" (P.3-9)

# 8.11 Control initial setting 2 level (L2)

This level contains initial settings for computational functions, including Control/Transfer output assignment, event input assignment, auxiliary output assignment, and first order lag operation enable/disable.

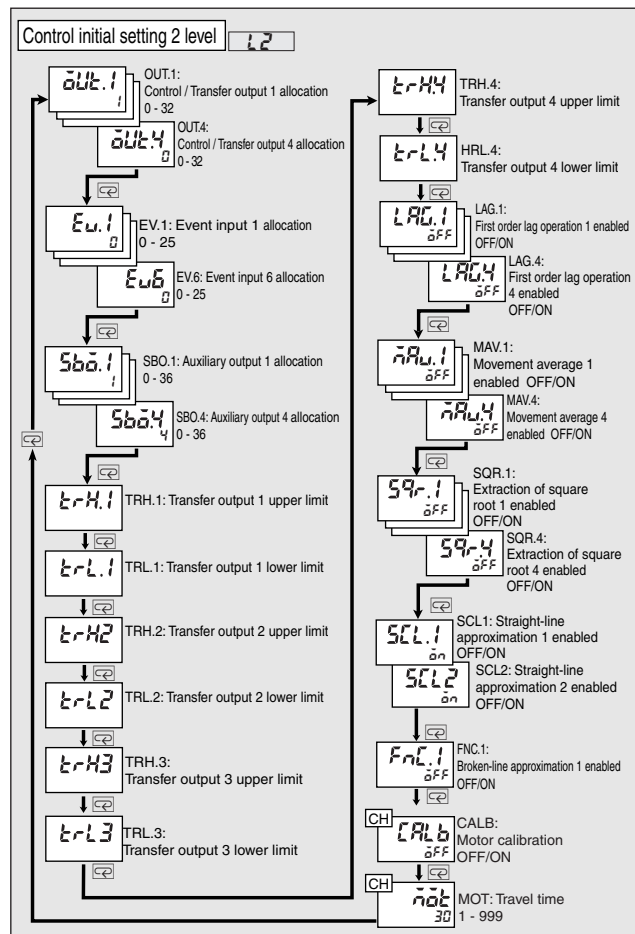
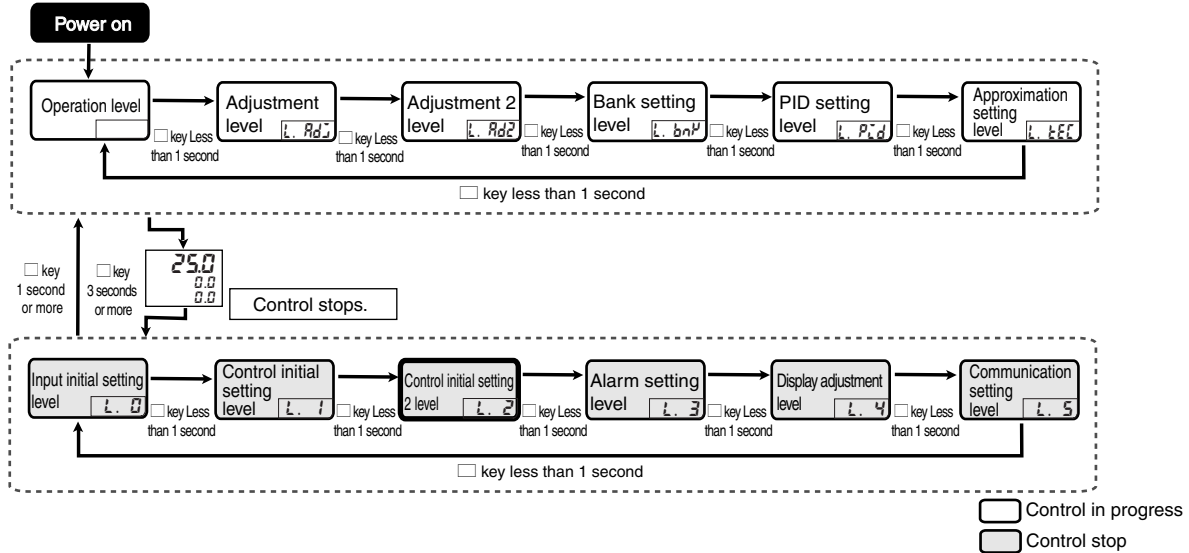

Setting data



|                                      |              |                                      |              |     |
|--------------------------------------|--------------|--------------------------------------|--------------|-----|
| Control/Transfer output 1 allocation | <i>ōut.1</i> | Control/Transfer output 3 allocation | <i>ōut.3</i> | 1.2 |
| Control/Transfer output 2 allocation | <i>ōut.2</i> | Control/Transfer output 4 allocation | <i>ōut.4</i> |     |



- Use this setting to assign output content to outputs.

| Setting range   | Units | Default value |
|---|-------|---------------|
| Disable (0)   |       |               |
| CH1 control output (heating or open) For control output (1)   |       |               |
| CH1 control output (cooling or close) For control output (2)  |       |               |
| CH1 SP (3)  |       |               |
| CH1 ramp SP (4)   |       |               |
| CH1 PV (5)  |       |               |
| CH1 control output (heating or open) For transfer output (6)  |       |               |
| CH1 control output (cooling or close) For transfer output (7) |       |               |
| CH1 valve opening (8)   |       |               |
| CH2 control output (heating) For control output (9)           |       |               |
| CH2 control output (cooling) For control output (10)          |       |               |
| CH2 SP (11)   |       |               |
| CH2 ramp SP (12)  |       |               |
| CH2 PV (13)   |       |               |
| CH2 control output (heating) For transfer output (14)         |       |               |
| CH2 control output (cooling) For transfer output (15)         |       |               |
| Similarly,<br>CH3 (17 to 23)                                  |       |               |
| CH4 (25 to 31)  |       |               |
|   | -     | *             |

\* The default value is set according to the control mode setting.

If transfer output is assigned to a bank output (3 to 8 in the case of CH1), the output will be OFF.

| Control mode                      | Input type | Control/Transfer output 1 assignment | Control/Transfer output 2 assignment | Control/Transfer output 3 assignment | Control/Transfer output 4 assignment |
|-----------------------------------|------------|--------------------------------------|--------------------------------------|--------------------------------------|--------------------------------------|
| Standard control                  | 1 input    | 1                                    | 0                                    | 0                                    | 0                                    |
|                                   | 2 inputs   | 1                                    | 9                                    | 0                                    | 0                                    |
|                                   | 4 inputs   | 1                                    | 9                                    | 17                                   | 25                                   |
| Heating/cooling control           | 1 input    | 1                                    | 2                                    | 0                                    | 0                                    |
|                                   | 2 inputs   | 1                                    | 2                                    | 9                                    | 10                                   |
|                                   | 4 inputs   | 1                                    | 2                                    | 9                                    | 10                                   |
| Remote SP standard control        | 1 input    | -                                    | -                                    | -                                    | -                                    |
|                                   | 2 inputs   | 1                                    | 0                                    | 0                                    | 0                                    |
|                                   | 4 inputs   | -                                    | -                                    | -                                    | -                                    |
| Remote SP heating/cooling control | 1 input    | -                                    | -                                    | -                                    | -                                    |
|                                   | 2 inputs   | 1                                    | 2                                    | 0                                    | 0                                    |
|                                   | 4 inputs   | -                                    | -                                    | -                                    | -                                    |
| Proportional control              | 1 input    | -                                    | -                                    | -                                    | -                                    |
|                                   | 2 inputs   | 1                                    | 0                                    | 0                                    | 0                                    |
|                                   | 4 inputs   | -                                    | -                                    | -                                    | -                                    |
| Cascade standard control          | 1 input    | -                                    | -                                    | -                                    | -                                    |
|                                   | 2 inputs   | 9                                    | 0                                    | 0                                    | 0                                    |
|                                   | 4 inputs   | -                                    | -                                    | -                                    | -                                    |
| Cascade heating/colling control   | 1 input    | -                                    | -                                    | -                                    | -                                    |
|                                   | 2 inputs   | 9                                    | 10                                   | 0                                    | 0                                    |
|                                   | 4 inputs   | -                                    | -                                    | -                                    | -                                    |
| Position proportional control     | 1 input    | -                                    | -                                    | 0                                    | 0                                    |



- Related setting data  
 "Linear current output \* type" (Control initial setting level) (P.8-42)  
 "Output 1 output type", "Output 3 output type" (Control initial setting level) (P.8-42)

|                          |             |                          |             |    |
|--------------------------|-------------|--------------------------|-------------|----|
| Event input 1 allocation | <i>Eu.1</i> | Event input 4 allocation | <i>Eu.4</i> | L2 |
| Event input 2 allocation | <i>Eu.2</i> | Event input 5 allocation | <i>Eu.5</i> |    |
| Event input 3 allocation | <i>Eu.3</i> | Event input 6 allocation | <i>Eu.6</i> |    |



- Use these settings to assign event input functions.



| Setting range                      | Units | Default value |
|------------------------------------|-------|---------------|
| Disable (0)                        |       |               |
| Write via communication OFF/ON (1) |       |               |
| CH1 Bank No. (Bit 0) (2)           |       |               |
| CH1 Bank No. (Bit 1) (3)           |       |               |
| CH1 Bank No. (Bit 2) (4)           |       |               |
| CH1 Run/Stop (5)                   |       |               |
| CH1 Auto/Manual (6)                |       |               |
| CH1 SP mode (Remote/Local) (7)     |       |               |
| CH2 Bank No. (Bit 0) (8)           | -     | 0             |
| CH2 Bank No. (Bit 1) (9)           |       |               |
| CH2 Bank No. (Bit 2) (10)          |       |               |
| CH2 Run/Stop (11)                  |       |               |
| CH2 Auto/Manual (12)               |       |               |
| CH2 SP mode (Remote/Local) (13)    |       |               |
| Similarly,                         |       |               |
| CH3 (14 to 19)                     |       |               |
| CH4 (20 to 25)                     |       |               |

- If the same setting is selected for different event input assignments, the event input for which ON/OFF is determined last will be effective. Note that when the power is turned on and the same bank No. assignment is repeated, the event input with the higher number is given priority.
- SP modes (Remote/Local) of CH2 to CH4 are disabled.

Important

When the control mode is set to cascade control, assign the following CH2 operation commands:

- CH2 Run/Stop (11)
- CH2 Auto/Manual (12)
- CH2 SP mode (Remote/Local) (13) Cascade open  
Cascade open / closed



- Related information  
 "5.7 Using event input" (P.5-29)

|                               |       |                               |       |    |
|-------------------------------|-------|-------------------------------|-------|----|
| Auxiliary output 1 allocation | Sb0.1 | Auxiliary output 3 allocation | Sb0.3 | L2 |
| Auxiliary output 2 allocation | Sb0.2 | Auxiliary output 4 allocation | Sb0.4 |    |



- Use these settings to assign output content to auxiliary outputs.



| Setting range                                  | Units | Default value |
|--|-------|---------------|
| Disable (0)                                    |       |               |
| CH1 Alarm 1 (1)                                |       |               |
| CH1 Alarm 2 (2)                                |       |               |
| CH1 Alarm 3 (3)                                |       |               |
| CH1 Alarm 4 (4)                                |       |               |
| CH1 Input error (5)                            |       |               |
| CH1RSP Input error (6)                         |       |               |
| Disabled (7)                                   |       |               |
| U-ALM (8)*                                     |       |               |
| Alarm 1 OR output of all channels (9)          |       |               |
| Alarm 2 OR output of all channels (10)         |       |               |
| Alarm 3 OR output of all channels (11)         |       |               |
| Alarm 4 OR output of all channels (12)         |       |               |
| Input error OR output of all channels (13)     | -     | 1 to 4        |
| RSP Input error OR output of all channels (14) |       |               |
| Disable (15)                                   |       |               |
| CH2 Alarm 1 (16)                               |       |               |
| CH2 Alarm 2 (17)                               |       |               |
| CH2 Alarm 3 (18)                               |       |               |
| CH2 Alarm 4 (19)                               |       |               |
| CH2 Input error (20)                           |       |               |
| CH2RSP Input error (21)                        |       |               |
| Disable (22)                                   |       |               |
| Similarly,                                     |       |               |
| CH3 (23 to 29)                                 |       |               |
| CH4 (30 to 36)                                 |       |               |

\* On a multi-point input type, assignment data can be set for channels 2 and higher as appropriate for the number of channels. U-ALM output will be OR output of alarm functions 1 to 4 of all channels.



- Related information  
"4.11 Using auxiliary output" (P.4-23)

Transfer output \* upper limit

LrH. \*

L2

Transfer output \* lower limit

LrL. \*

(\*: 1 to 4)

Transfer output using output assignment



- These settings can only be used for outputs selected for transfer output using output assignment.



| Control/<br>Transfer output<br>assignment<br>data | Setting range   | Default value<br>(upper limit/<br>lower limit of<br>transfer<br>output) *1 | Decimal<br>point<br>position | units |
|---|---|--|------------------------------|-------|
| SP  | SP lower limit to<br>SP upper limit   | 1300.0/-200.0  | Depends on<br>input type     | EU    |
| Ramp SP   | SP lower limit to<br>SP upper limit   | 1300.0/-200.0  | Depends on<br>input type     | EU    |
| PV  | Lower limit of<br>sensor setting<br>range to upper<br>limit of sensor<br>setting range<br>(temperature) | Upper- and<br>lower-limit of<br>sensor setting<br>range                    | Depends on<br>input type     | EU    |
|   | -19999 to 99999<br>(analog)   | Scaling display<br>value 2/1   | Depends on<br>input type     | EU    |
| Control output<br>(heating or<br>open)            | Standard: -5.0 to<br>105.0; Heating/<br>cooling: 0.0 to<br>105.0  | 100.0/0.0  | 1                            | %     |
| Control output<br>(cooling or<br>close)           | 0.0 to 105.0  | 100.0/0.0  | 1                            | %     |
| Valve opening                                     | -10.0 to 110.0  | 100.0/0.0  | 1                            | %     |

\*1 Will be initialized if the input type, temperature units, scaling display value, SP upper- and lower-limit, or applicable control/transfer output assignment is changed.



- Related information  
"5.8 Using transfer output" (P.5-32)
- Related setting data  
"Input \* type" (Input initial setting level) (P.8-36)  
"Control/Transfer output \* assignment" (Control initial setting 2 level) (P.8-46)

First order lag operation 1 enable *LAG.1*    First order lag operation 3 enable *LAG.3*    L2  
 First order lag operation 2 enable *LAG.2*    First order lag operation 4 enable *LAG.4*



- Use these settings to enable or disable first order lag operation for each input.



| Setting range        | Units | Default value |
|----------------------|-------|---------------|
| <i>OFF</i> : Disable | —     | <i>OFF</i>    |
| <i>ON</i> : Enable   |       |               |



- Related information  
"5.1 Input adjustment functions" (P.5-2)
- Related setting data  
"First order lag operation \*: Time constant" (Adjustment level 2) (P.8-22)

Movement average 1 enable *MA.1*    Movement average 3 enable *MA.3*    L2  
 Movement average 2 enable *MA.2*    Movement average 4 enable *MA.4*



- Use these settings to enable or disable move average for each input.



| Setting range        | Units | Default value |
|----------------------|-------|---------------|
| <i>OFF</i> : Disable | —     | <i>OFF</i>    |
| <i>ON</i> : Enable   |       |               |



- Related setting data  
"Move average \* Move average count" (Adjustment level 2) (P.8-23)

|                                    |       |                                    |       |    |
|------------------------------------|-------|------------------------------------|-------|----|
| Extraction of square root 1 enable | 59r.1 | Extraction of square root 3 enable | 59r.3 | L2 |
| Extraction of square root 2 enable | 59r.2 | Extraction of square root 4 enable | 59r.4 |    |



- Use these settings to enable or disable extraction of square root operations for each input.



| Setting range                | Units | Default value |
|------------------------------|-------|---------------|
| 0FF : Disable<br>0n : Enable | –     | 0FF           |



- Related setting data  
"Extraction of square root \* Low-cut point" (Adjustment level 2) (P.8-24)

|                                      |       |                      |
|--------------------------------------|-------|----------------------|
| Straight-line approximation 1 enable | 5CL.1 | L2                   |
| Straight-line approximation 2 enable | 5CL.2 | Proportional control |



- Use these settings to enable or disable straight-line approximation.



| Setting range                | Units | Default value |
|------------------------------|-------|---------------|
| 0FF : Disable<br>0n : Enable | –     | 0FF           |



- Related setting data  
"Straight-line approximation \* input 1", "Straight-line approximation \* input 2", "Straight-line approximation \* output 1", "Straight-line approximation \* output 2" (Approximation setting level) (P.8-33)

|                                    |       |    |
|------------------------------------|-------|----|
| Broken-line approximation 1 enable | FnL.1 | L2 |
|------------------------------------|-------|----|



- Use this setting to enable or disable broken-line approximation for input 1.



| Setting range                | Units | Default value |
|------------------------------|-------|---------------|
| 0FF : Disable<br>0n : Enable | –     | 0FF           |



- Related setting data  
"Broken-line approximation 1 Input 1" to "Broken-line approximation 1 Input 20", "Broken-line approximation 1 Output 1" to "Broken-line approximation 1 Output 20" (Approximation setting level) (P.8-34)

CH

Motor calibration

CALb

1.2

Position proportional type



- Use this setting to run motor calibration. If you are going to monitor the valve opening, be sure to execute this setting. (During execution the display cannot be changed.)
- Executing this setting also resets "Travel time".



Operation

- When this setting is accessed, the set value is "ōFF".
- Select "ōn" to run motor calibration.
- When motor calibration ends, the setting automatically reverts to "ōFF".



- Related information  
"3.3 Position proportional control of a ceramic kiln ■ Settings for position proportional control" (P.3-12)
- Related parameters  
"Travel time" (Control initial setting 2 level) (P.8-52)

CH

Travel time

TRt

1.2

Position proportional type



- Set the time from valve completely open to valve completely closed.
- This parameter is automatically set when "Motor calibration" is run.



Setting

| Setting range | Units | Default value |
|---------------|-------|---------------|
| 1 to 999      | Sec   | 30            |



- Related information  
"3.3 Position proportional control of a ceramic kiln ■ Settings for position proportional control" (P.3-12)
- Related parameters  
"Motor calibration" (Control initial setting 2 level) (P.8-52)

# 8.12 Alarm setting level (L.3)

This level contains settings for the type and output operation of alarms, including alarm type, close in alarm/open in alarm, and latch settings.

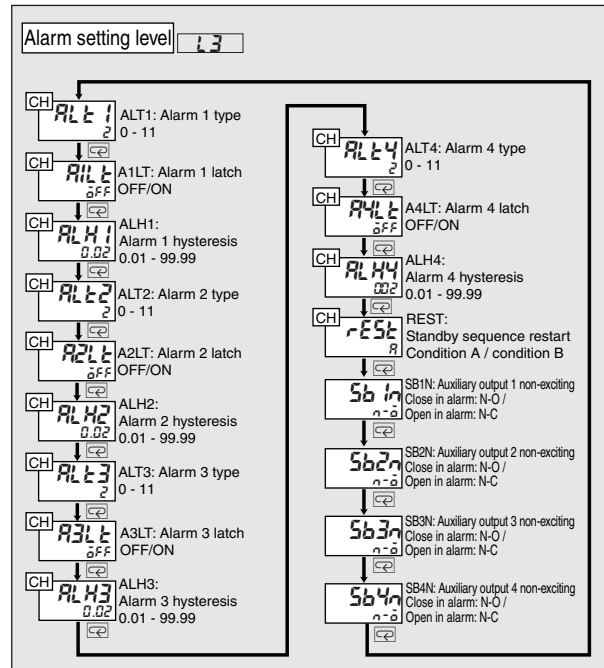
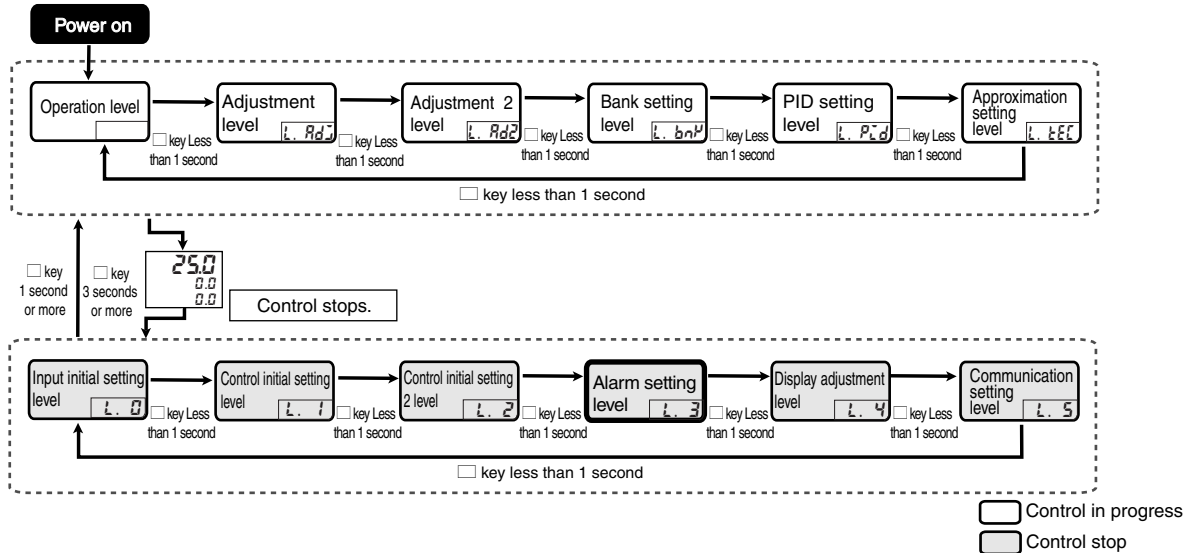

Setting data



CH

|              |              |  |
|--------------|--------------|--|
| Alarm 1 type | <i>ALt 1</i> | L3                                     |
| Alarm 2 type | <i>ALt 2</i> |  |
| Alarm 3 type | <i>ALt 3</i> |  |
| Alarm 4 type | <i>ALt 4</i> | Alarm is assigned to auxiliary output. |



- These settings are used to select the type of alarms 1 through 4.



| Setting data   | Setting range   | Units | Default value        |
|--|---|-------|----------------------|
| Alarm 1 type<br>Alarm 2 type<br>Alarm 3 type<br>Alarm 4 type | 0: No alarm function<br>1: Upper- and lower-limit alarm<br>2: Upper limit alarm<br>3: Lower limit alarm<br>4: Upper- and lower-limit range alarm<br>5: Upper- and lower-limit alarm with standby sequence<br>6: Upper limit alarm with standby sequence<br>7: Lower limit alarm with standby sequence<br>8: Absolute-value upper-limit alarm<br>9: Absolute-value lower-limit alarm<br>10: Absolute-value upper-limit alarm with standby sequence<br>11: Absolute-value lower-limit alarm with standby sequence | -     | 2: Upper limit alarm |



- Related setting data
  - "Bank \* alarm value \* " (Bank setting level) (P.8-28)
  - "Bank \* alarm upper limit \* ", "Bank \* alarm lower limit \* " (Bank setting level) (P.8-29)
  - "Auxiliary output \* assignment" (Control initial setting 2 level) (P.8-48)
  - "Alarm \* latch" (Alarm setting level) (P.8-55)
  - "Alarm \* hysteresis" (Alarm setting level) (P.8-56)
  - "Standby sequence restart" (Alarm setting level) (P.8-57)

CH

|               |      |   |
|---------------|------|---|
| Alarm 1 latch | A1Lt | L.3   |
| Alarm 2 latch | A2Lt |   |
| Alarm 3 latch | A3Lt | Alarm is assigned to auxiliary output and   |
| Alarm 4 latch | A4Lt | alarm type is set to other than "No alarm". |



- When this setting is set to "ON", a latch function is added to the alarm function. Once an alarm goes on, the alarm output is held on until the power is turned off. Note that the latch is canceled if you change to setting area 1.
- When the alarm output is set to close in alarm, closed output is held, and when set to open in alarm, open output is held.
- After changing an alarm 1 to 3 latch setting, a software reset must be executed or the power turned off and on to make the new setting take effect.



| Setting data  | Setting range                | Units | Default value |
|---------------|------------------------------|-------|---------------|
| Alarm 1 latch | OFF : Disable<br>ON : Enable | -     | OFF : Disable |
| Alarm 2 latch |                              |       |               |
| Alarm 3 latch |                              |       |               |
| Alarm 4 latch |                              |       |               |



- Related setting data
  - "Bank \* alarm \*" (Bank setting level) (P.8-28)
  - "Bank \* alarm upper limit \* ", "Bank \* alarm lower limit \* " (Bank setting level) (P.8-29)
  - "Auxiliary output \* assignment" (Control initial setting 2 level) (P.8-48)
  - "Alarm \* type" (Alarm setting level) (P.8-54)
  - "Alarm \* hysteresis" (Alarm setting level) (P.8-56)
  - "Standby sequence restart" (Alarm setting level) (P.8-57)

CH

|                    |             |   |
|--------------------|-------------|---|
| Alarm 1 hysteresis | <i>ALH1</i> | L3  |
| Alarm 2 hysteresis | <i>ALH2</i> |   |
| Alarm 3 hysteresis | <i>ALH3</i> | Alarm is assigned to auxiliary output and alarm type is set to other than "No alarm". |
| Alarm 4 hysteresis | <i>ALH4</i> |   |



- These settings are used to enable hysteresis for alarms 1, 2, 3, and 4.



| Setting data   | Setting range | Units | Default value |
|--|---------------|-------|---------------|
| Alarm 1 hysteresis<br>Alarm 2 hysteresis<br>Alarm 3 hysteresis<br>Alarm 4 hysteresis | 0.01 to 99.99 | %FS   | 0.02          |



- Related setting data  
 "Bank \* alarm \*" (Bank setting level) (P.8-28)  
 "Bank \* alarm upper limit \* ", "Bank \* alarm lower limit" (Bank setting level) (P.8-29)  
 "Auxiliary output \* assignment" (Control initial setting 2 level) (P.8-48)  
 "Alarm \* type" (Alarm setting level) (P.8-54)  
 "Alarm \* latch" (Alarm setting level) (P.8-55)  
 "Standby sequence restart" (Alarm setting level) (P.8-57)

CH

Standby sequence restart

rESE

L.3

Alarm types 1 to 4 = With standby sequence



- Use this setting to select the condition for restarting the standby sequence after it has been canceled.
- Condition A: Operation startup (including power on), when an alarm value (alarm upper- and lower-limit) or input shift value (input value for input calibration 1 and 2, input shift 1 and 2) is changed, or when the SP is changed.
- Condition B: Power on
- The following example shows operation using a lower-limit alarm with standby sequence.

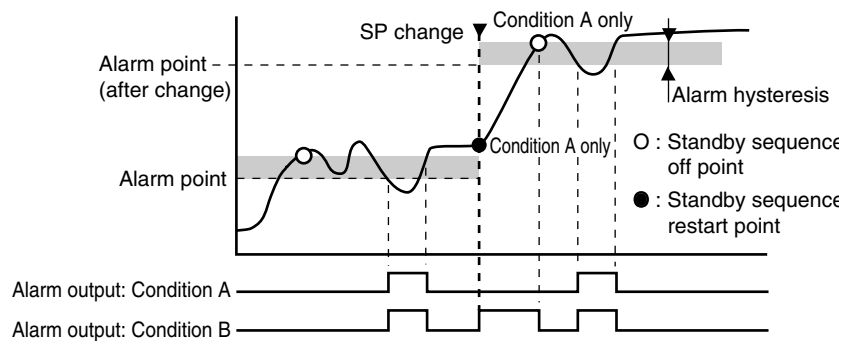

- After changing the standby sequence restart setting, a software reset must be executed or the power turned off and on to make the change take effect.



Setting

| Setting range                                      | Units | Default value           |
|--|-------|-------------------------|
| $\bar{r}$ : Condition A<br>$\bar{b}$ : Condition B | —     | $\bar{r}$ : Condition A |



Reference

- Related setting data
  - "Alarm \* type" (Alarm setting level) (P.8-54)
  - "Alarm \* latch" (Alarm setting level) (P.8-55)

|                                 |      |    |
|---------------------------------|------|----|
| Auxiliary output 1 non-exciting | Sb1n | L3 |
| Auxiliary output 2 non-exciting | Sb2n |    |
| Auxiliary output 3 non-exciting | Sb3n |    |
| Auxiliary output 4 non-exciting | Sb4n |    |



- These settings are used to select the output state of alarms 1, 2, 3, and 4.
- When close in alarm is selected, the state of the alarm output function is output without change. When open in alarm is selected, the state of the output function is inverted before output. The relation between the alarm output function, alarm output, and operation indicator is shown below.

| Setting data   | Auxiliary output function | Auxiliary output | Operation indicator |
|----------------|---------------------------|------------------|---------------------|
| Close in alarm | ON                        | ON               | On                  |
|                | OFF                       | OFF              | Off                 |
| Open in alarm  | ON                        | OFF              | On                  |
|                | OFF                       | ON               | Off                 |



| Setting data                    | Setting range       | Units | Default value       |
|---------------------------------|---------------------|-------|---------------------|
| Auxiliary output 1 non-exciting | n-a: Close in alarm | -     | n-a: Close in alarm |
| Auxiliary output 2 non-exciting | n-b: Open in alarm  |       |                     |
| Auxiliary output 3 non-exciting |                     |       |                     |
| Auxiliary output 4 non-exciting |                     |       |                     |



- Related setting data
  - "Bank \* alarm \*" (Bank setting level) (P.8-28)
  - "Bank \* alarm upper limit \* ", "Bank \* alarm lower limit" (Bank setting level) (P.8-29)
  - "Auxiliary output \* assignment" (Control initial setting level 2) (P.8-48)
  - "Alarm \* type" (Alarm setting level) (P.8-54)
  - "Alarm \* latch" (Alarm setting level) (P.8-55)
  - "Alarm \* hysteresis" (Alarm setting level) (P.8-56)
  - "Standby sequence restart" (Alarm setting level) (P.8-57)

# 8.13 Display adjustment level (L.4)

This level contains settings for adjustment of the display contents, including selection of the "PV/SP" display screen, bar graph display item, display refresh period, monitor item level setting, and display scan.

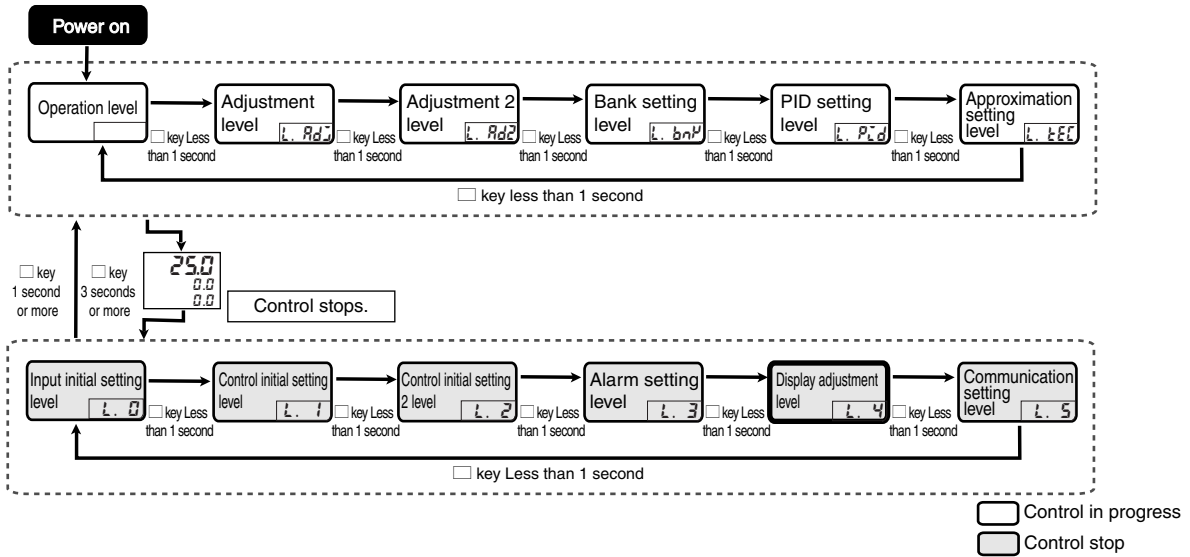

**Display Adjustment level** L.4

- SPDP: "PV/SP" display screen selection  
0 - 3
- ODSL: MV display selection  
MV (heating): O/  
MV (cooling): C-O
- BART: Bar graph display item  
OFF/Deviation: 1 EU, 10 EU, 20 EU, 100 EU/  
MV (heating) · Valve opening: O/MV (cooling): C-O
- RET: Display auto-return time  
0 - 99  
(0: Display auto-return disabled)
- D.REF: Display refresh period  
OFF/0.5/1/2/4
- MONL: Monitor item level setting  
\*1 Disabled : OFF
- SC-M: Start display scan at power on  
OFF/ON
- SC-T: Display scan period  
0 - 99

- Input initial setting level : L.0
- Control initial setting level : L.1
- Control initial setting 2 level : L.2
- Alarm setting level : L.3
- Display adjustment level : L.4
- Communication setting level : L.5
- Advanced function setting level : L.ADF
- Expansion control setting level : L.EXC

Setting data

"PV/SP" display screen selection

SPdP

2.4



- This setting is used to select the order of display of the "PV/SP" display screen (Operation level).



| Setting range                                    | Units | Default value |
|--|-------|---------------|
| 0: Display in the order: "PV/SP/Bank" "PV/SP/MV" |       |               |
| 1: Display in the order: "PV/SP/MV" "PV/SP/Bank" | -     | ,             |
| 2: Display only "PV/SP/Bank"                     |       |               |
| 3: Display only "PV/SP/MV"                       |       |               |

CH

MV display selection

ōdSL

2.4

Heating/cooling control



- This setting is used to select which MV is displayed in "PV/SP/MV" (Operation level) during heating/cooling control.
- "Heating MV" or "Cooling MV" can be selected.



| Setting range      | Units | Default value |
|--------------------|-------|---------------|
| ō : Heating MV     |       | ō             |
| ē - ō : Cooling MV | -     |               |

Bar graph display item

bARt

L.4

E5AR



- Use this setting to select the contents of the bar graph display of the E5AR.
- The bar graph of the E5AR is 10 segments.



Setting

| Setting range  | Units | Default value |
|--|-------|---------------|
| OFF : No bar graph display   |       |               |
| 1EU : Deviation 1 EU/segment   |       |               |
| 10EU : Deviation 10 EU/segment   |       |               |
| 20EU : Deviation 20 EU/segment   |       |               |
| 100EU : Deviation 100 EU/segment   |       |               |
| 0 : (Standard type) Heating MV<br>(Position proportional type) Valve opening | -     | 0             |
| 1-0 : (Standard type) Cooling MV   |       |               |

Display auto-return time

rEt

L.4



- This setting is used to select the amount of time without key operation that must elapse for the display to revert to the "PV/SP" screen when in "Operation level", "Adjustment level", "Adjustment level 2", "Bank setting level", "PID setting level", "Approximation setting level", or "Monitor item level".
- When 0 is selected, the function is disabled (no auto reset).



Setting

| Setting range | Units | Default value |
|---------------|-------|---------------|
| 0 to 99       | Sec   | 0             |

Display refresh period

dREF

L.4



- This setting is used to lengthen the refresh period of the monitor value display. This only slows the display refresh cycle; it does not affect the update period of the PV during control.
- To disable the function, select OFF.



Setting

| Setting range     | Units | Default value |
|-------------------|-------|---------------|
| OFF, 0.5, 1, 2, 4 | Sec   | 0.5           |



Monitor item level setting

モニタレベル

L.4



- One of the following levels can be selected as the monitor item level setting: Input initial setting level, Control initial setting level, Control initial setting 2 level, Alarm setting level, Display adjustment level, Communication setting level, Advanced function setting level, Expansion control setting level.
- The monitor item level is added after the Approximation setting level.
- When OFF is selected, the function is disabled (Monitor item level is disabled).



| Setting range   | Units | Default value |
|---|-------|---------------|
| OFF : Disabled monitor item level<br>L.0 : Input initial setting level<br>L.1 : Control initial setting level<br>L.2 : Control initial setting 2 level<br>L.3 : Alarm setting level<br>L.4 : Display adjustment level<br>L.5 : Communication setting level<br>L.AdF : Advanced function setting level<br>L.ExpC : Expansion control setting level | -     | OFF           |

Start display scan after power ON

SC-n

L.4

Display scan period

SC-t

Multi-point input type



- Display scan automatically switches through channels on the display when multiple channels are used on a multi-point input type.
- Display scan only applies to channels that are enabled using "Number of enabled channels".
- Display scan can be started automatically after the power is turned on or by pressing the **[CH]** key.
- To have display scan start automatically after the power is turned on, set "Start display scan after power on" to ON.
- The display scan period is set with "Display scan period". When the period is set to "0", display scan is disabled.



| Setting data                      | Setting period                       | Units | Default value |
|-----------------------------------|--------------------------------------|-------|---------------|
| Display scan period               | 0 to 99<br>(0: Disable display scan) | Sec   | 2             |
| Start display scan after power on | OFF : Disable<br>ON : Enable         | -     | OFF           |

# 8.14 Communication setting level (L.5)

This level contains initial settings for communication such as protocol selection, communication unit No., and communication speed.

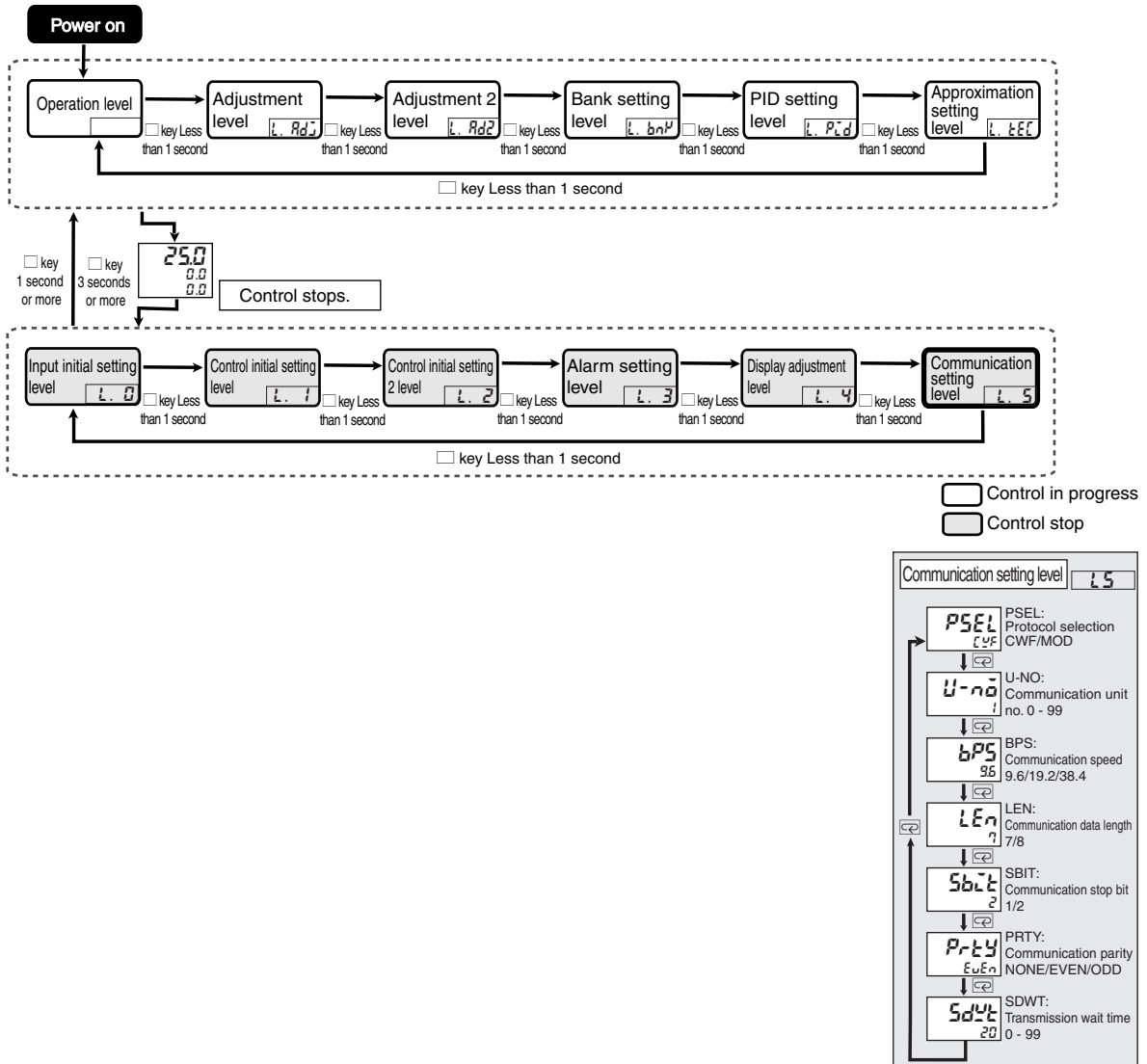

Setting data

Communication protocol selection **PSEL** L5



- This setting is used to select the communication protocol. Selections are CompoWay/F, OMRON's unified protocol for general-purpose serial communication, or Modbus, Modicon Inc.'s protocol based on RTU Mode of Modbus Protocol (Specifications: PI-MBUS-300 Rev.J).



| Setting range                  | Units | Default value   |
|--------------------------------|-------|-----------------|
| 𐄂𐄂F: CompoWay/F<br>𐄂𐄂d: Modbus | –     | 𐄂𐄂F: CompoWay/F |

Communication Unit No. **U-nō** L5



- After changing the communication unit No. setting, execute a software reset or turn the power off and on to make the change effective.



| Setting range | Units | Default value |
|---------------|-------|---------------|
| 0 to 99       | –     | 1             |

Communication speed **bPS** L5



- After changing the communication speed setting, execute a software reset or turn the power off and on to make the change effective.



| Setting range       | Units | Default value |
|---------------------|-------|---------------|
| 9.6<br>19.2<br>38.4 | kbps  | 9.6           |

Communication data length

LEN

L5

Protocol is CompoWay/F



- After changing the communication data length setting, execute a software reset or turn the power off and on to make the change effective.



| Setting range | Units | Default value |
|---------------|-------|---------------|
| 7 to 8        | Bits  | 7             |

Communication stop bit

SBCT

L5

Protocol is CompoWay/F



- After changing the communication stop bit setting, execute a software reset or turn the power off and on to make the change effective.



| Setting range | Units | Default value |
|---------------|-------|---------------|
| 1 to 2        | Bits  | 2             |

Communication parity

PRTY

L5



- After changing the communication parity setting, execute a software reset or turn the power off and on to make the change effective.



| Setting range  | Units | Default value      |
|--|-------|--------------------|
| <i>nōnē</i> : None<br><i>EvEn</i> : Even<br><i>ōdd</i> : Odd | –     | <i>EvEn</i> : Even |

Transmission wait time

5d4t

1.5



Function

- After changing the transmission wait time setting, execute a software reset or turn the power off and on to make the change effective.



Setting

| Setting range | Units | Default value |
|---------------|-------|---------------|
| 0 to 99       | ms    | 20            |

# 8.15 Advanced function setting level (L.RdF)

This level includes setting initialization, PF key, and number of enabled channels settings.

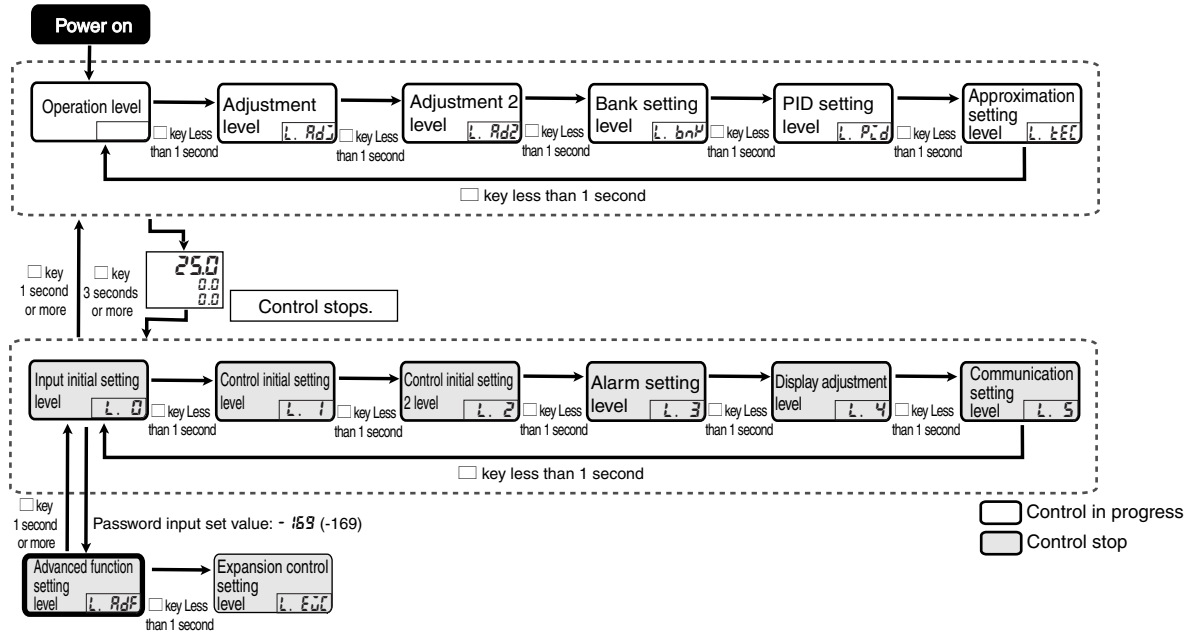

To move to Advanced function setting level, set "Initial setting level protect" in Protect level to "0", and then enter the password (-169) in "Move to Advanced function setting level" (Input initial setting level).

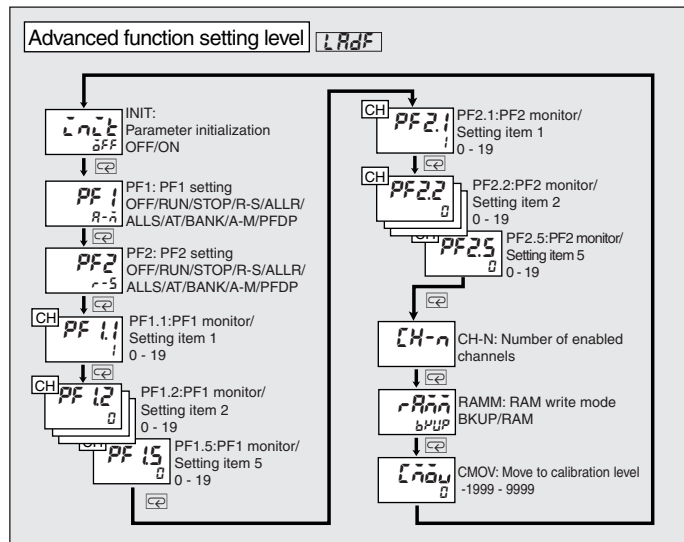

Setting data

Setting initialization

初期設定

LOAD



- Use this setting to return all settings to their default values.



ON (ON) : Initialize all settings.

OFF (OFF) : "Setting initialization" reverts to "OFF" after the settings are initialized.

PF1 setting

PF1

LOAD

PF2 setting

PF2



- This setting is used to assign functions to the PF1 and PF2 keys to enable them to be used as function keys.
- When performing multi-channel control, the PF2 key functions as a CH key, and thus cannot be used as a function key ("PF2 setting" does not appear).

| Setting values | Description          | Function   |
|----------------|----------------------|--|
| OFF: OFF       | Disabled             | Does not function as a function key.   |
| RUN: RUN       | Run                  | Run currently displayed channel.   |
| STOP: STOP     | Stop                 | Stop currently displayed channel.  |
| R-S: R-S       | Run/Stop             | Switch between run and stop for currently displayed channel.   |
| ALLR: ALLR     | Run all              | Run all channels.  |
| ALLS: ALLS     | Stop all             | Stop all channels.   |
| AT: AT         | AT Execute/Cancel    | Switch between AT execute and AT cancel.<br>AT run is executed for the currently selected PID set.                     |
| BANK: BANK     | Bank selection       | Switch through the bank numbers (adds 1 to the current bank number).   |
| A-M: A-M       | [A/M] key            | Switch between auto and manual.  |
| PFDP: PFDP     | Monitor/Setting item | Display monitor/setting item.<br>Select "Monitor/Setting item 1" to "Monitor/Setting item 5" (Special function level). |

- Hold down the PF1 or PF2 for at least 1 second to execute the function selected in "PF1 setting" or "PF2 setting".  
If "Monitor/Setting item" is selected, the display will scroll through monitor/setting items 1 to 5 each time you press the key.



| Setting data | Setting range   | Units | Default value        |
|--------------|---|-------|----------------------|
| PF1 setting  | 0FF : Disable<br>rUn : Run<br>St0P : Stop<br>r-S : Run/Stop toggle<br>RLLr : Run all<br>RLLS : Stop all | -     | R-n:  key            |
| PF2 setting  | Rk : AT Execute/Cancel<br>toggle<br>bRnV : Bank scroll<br>R-n :  key<br>PFdP : Monitor/setting item     | -     | r-S: Run/Stop toggle |

CH

PF1 monitor/setting item 1 to  
 PF1 monitor/setting item 5  
 PF2 monitor/setting item 1 to  
 PF2 monitor/setting item 5

PF 1.1 to  
 PF 1.5  
 PF 2.1 to  
 PF 2.5

**L.RdF**

PF key set to monitor/setting item



- When one or both PF keys are set to monitor/setting item, "Monitor/setting item 1" through "Monitor/setting item 5" of each key must be set to the desired values among 0 to 19 below.
- Each time a PF key is pressed, the display scrolls to the next monitor/setting item in order from "Monitor/setting item 1" to "Monitor setting item 5".



| Setting                    | Setting range                         | Units | Default value |
|----------------------------|---------------------------------------|-------|---------------|
| PF1 Monitor/setting item 1 | 0: Disable                            | -     | 1             |
| PF1 Monitor/setting item 2 | 1: PV/SP/Bank Configurable (SP)       |       | 0             |
| PF1 Monitor/setting item 3 | 2: V/SP/MV Configurable (SP)          |       | 0             |
| PF1 Monitor/setting item 4 | 3: PV/DV Monitor only                 |       | 0             |
| PF1 Monitor/setting item 5 | 4: Proportional band (P) Configurable |       | 0             |
| PF2 Monitor/setting item 1 | 5: Integral time (I) Configurable     |       | 0             |
| PF2 Monitor/setting item 2 | 6: Derivative time (D) Configurable   |       | 0             |
| PF2 Monitor/setting item 3 | 7: Alarm 1 Configurable               |       | 0             |
| PF2 Monitor/setting item 4 | 8: Alarm upper limit 1 Configurable   |       | 0             |
| PF2 Monitor/setting item 5 | 9: Alarm lower limit 1 Configurable   |       | 1             |
| PF2 Monitor/setting item 1 | 10: Alarm 2 Configurable              |       | 0             |
| PF2 Monitor/setting item 2 | 11: Alarm upper limit 2 Configurable  |       | 0             |
| PF2 Monitor/setting item 3 | 12: Alarm lower limit 2 Configurable  |       | 0             |
| PF2 Monitor/setting item 4 | 13: Alarm 3 Configurable              |       | 0             |
| PF2 Monitor/setting item 5 | 14: Alarm upper limit 3 Configurable  |       | 0             |
| PF2 Monitor/setting item 1 | 15: Alarm lower limit 3 Configurable  |       | 0             |
| PF2 Monitor/setting item 2 | 16: Alarm 4 Configurable              |       | 0             |
| PF2 Monitor/setting item 3 | 17: Alarm upper limit 4 Configurable  |       | 0             |
| PF2 Monitor/setting item 4 | 18: Alarm lower limit 4 Configurable  |       | 0             |
| PF2 Monitor/setting item 5 | 19: Bank No. Configurable             | 0     |               |

Setting data



- Related setting data  
 "PF1 setting", "PF2 setting" (Advanced function setting level) (P.8-68)



Number of enabled channels

*CH-n*

*L.PdF*

Multi-point input type



Function

- This setting is used to set the number of enabled channels when using multiple channels on a multi-point input type.



Setting

| Setting range | Units | Default value |
|---------------|-------|---------------|
| 1 to 4        | –     | *             |

- \* The default value and setting range vary depending on the control mode setting of the multi-point input type.

2-input type: Proportional control, standard control with remote SP, heating/cooling control with remote SP: "1"

Other modes: "2"

4-input type: "4"



Reference

- Related setting data  
"Begin display scan after power on", "Display scan period" (Display adjustment level) (P.8-62)

RAM write mode

*r.Rn*

*L.PdF*



Function

- Use this setting to select the write mode.

| Write mode     | Explanation  |
|----------------|--|
| Backup mode    | When writing setting data to setting area 0 by communication, the data is also written to internal non-volatile memory.  |
| RAM write mode | When writing setting data to setting area 0 by communication, the data is not written to internal non-volatile memory. However, changes to setting data by key operation are written to non-volatile memory. |

- When the write mode is changed from RAM write mode to backup mode, the setting data in setting area 0 is written to internal non-volatile memory.



Setting

| Setting range  | Units | Default value              |
|--|-------|----------------------------|
| <i>b.PdP</i> : Backup mode<br><i>r.Rn</i> : RAM write mode | –     | <i>b.PdP</i> : Backup mode |



Reference

- Related information  
"5.9 Using communication functions" (P.5-34)

Move to calibration level

[F5]

L.RdF

This setting is used to move to calibration level.



- Use this setting to enter the password to access calibration level.



Setting

| Setting range | Units | Default value |
|---------------|-------|---------------|
| -1999 to 9999 | –     | 0             |



Reference

- Related information  
"Section 9 User calibration" (P. 9-1)

# 8.16 Expansion control setting level (L.EUL)

This level includes advanced control settings such as operation after power ON, PID set auto selection, and position proportional settings.

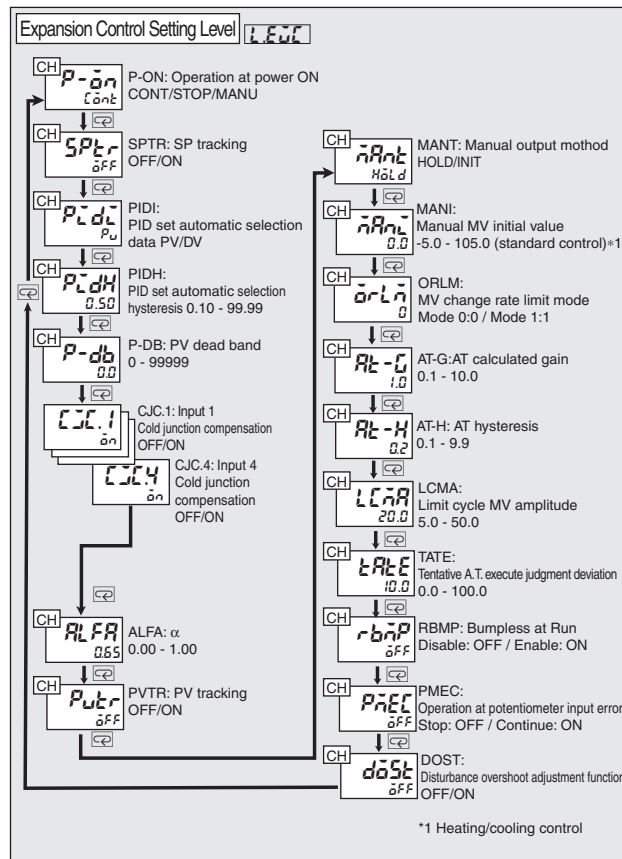
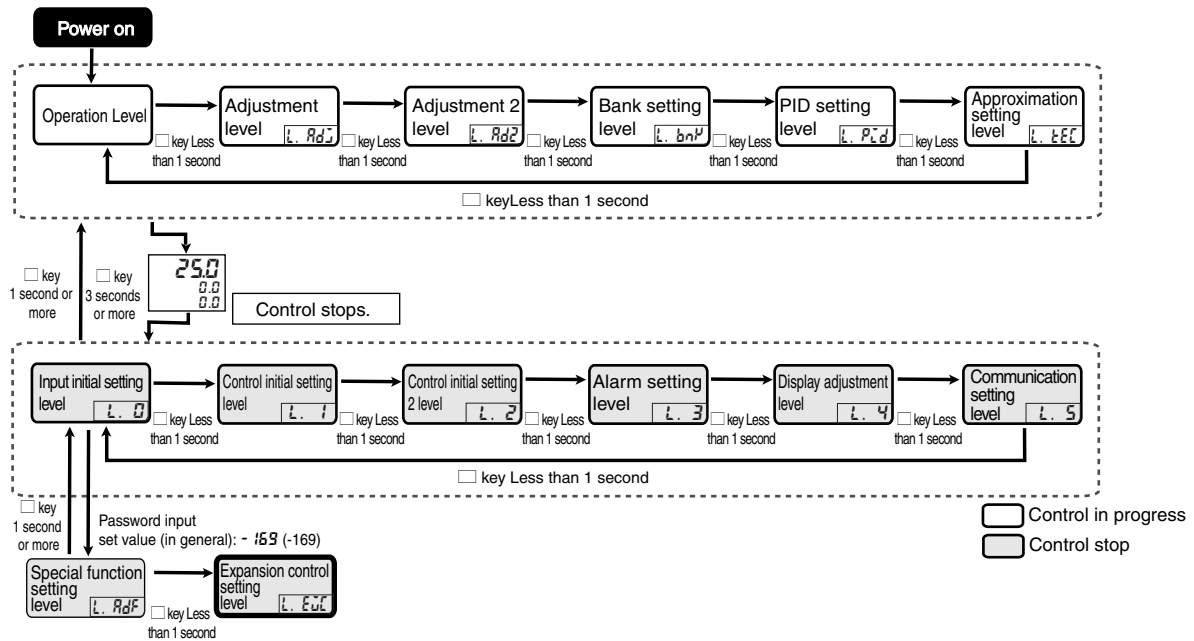

CH

Operation at power ON

P-on

LEUC



- Select "Continue", "Stop", or "Manual mode" for operation after the power is turned on.
- Operation after a software reset or when moving from Initial setting level to Operation level is also determined by this setting.



| Setting range  | Units | Default value      |
|--|-------|--------------------|
| Continue: Continue<br>Stop: Stop<br>Manual mode: Manual mode | -     | Continue: Continue |



- Related information  
"4.12 Starting and stopping control" (P.4-27)

CH

SP tracking

SPtr

LEUC

Standard control with remote SP, cascade control, or proportional control



- This setting is used to specify operation when switching from remote SP mode to local SP mode.
- When remote SP tracking is enabled (ON), the value of the remote SP is transferred to the local SP.
- When remote SP tracking is disabled (OFF), the local SP is not affected by the remote SP.



| Setting range              | Units | Default value |
|----------------------------|-------|---------------|
| OFF: Disable<br>ON: Enable | -     | OFF           |



- Related setting data  
"Control mode" (Control initial setting level) (P.8-43)  
"SP mode" (Adjustment level) (P.8-14)

CH

PID set automatic selection data

PID

LEGE

PID set automatic selection hysteresis

PIDH

CH



- This setting is used for automatic selection of the PID set.
- The PID set number to be used is automatically selected based on the value set in "PID set automatic selection data". The switching range is specified in the "PID set automatic select range" (PID setting level).
- "PID set automatic selection hysteresis" is used to prevent chattering when the PID is changed.



| Setting                                | Setting range  | Units | Default value                  |
|--|--|-------|--------------------------------|
| PID set automatic selection data       | P <sub>u</sub> : Present value<br>d <sub>u</sub> : Deviation | -     | P <sub>u</sub> : Present value |
| PID set automatic selection hysteresis | 0.10 to 99.99  | %FS   | 0.50                           |



- Related information  
"5.2 Control functions ■ PID sets" (P.5-12)
- Related setting data  
"Bank \* PID Set No." (Bank setting level) (P.8-27)  
"PID Set No. \* Automatic selection range upper limit" (PID setting level) (P.8-32)

CH

PV dead band

P-db

LEGE

Position proportional type



- This setting is used on a position proportional type to have PV = SP when the PV is within the PV dead band.
- This function prevents unnecessary output when the PV is near the SP.



| Setting      | Setting range | Units | Default value |
|--------------|---------------|-------|---------------|
| PV dead band | 0 to 99999    | EU    | 0             |



- Related information  
"3.3 Position proportional control of a ceramic kiln" (P.3-9)
- Related setting data  
"Closed/Floating" (Control initial setting level) (P.8-44)  
"Motor calibration" (Control initial setting 2 level) (P.8-52)  
"Travel time" (Control initial setting 2 level) (P.8-52)  
"Position proportional dead band" (Adjustment level) (P.8-17)  
"Open/Close hysteresis" (Adjustment level) (P.8-17)  
"Operation at potentiometer input error" (Expansion control setting level) (P.8-79)

|                                    |        |                                  |
|------------------------------------|--------|----------------------------------|
| Input 1 cold junction compensation | CJ.C.1 | L.E.U.C                          |
| Input 2 cold junction compensation | CJ.C.2 |                                  |
| Input 3 cold junction compensation | CJ.C.3 |                                  |
| Input 4 cold junction compensation | CJ.C.4 | Input type is thermocouple input |



- When the input type is thermocouple input, this setting is used to specify whether cold junction compensation is performed inside the controller or outside the controller.
- Select "External" cold junction compensation when two thermocouples are used to measure the temperature difference or when an external cold junction compensator is used for increased accuracy.



| Setting range  | Units | Default value |
|----------------|-------|---------------|
| 0FF : External | -     | 0n : Internal |
| 0n : Internal  |       |               |



- Related setting data  
"Input \* type" (Input initial setting level) (P.8-36)

CH  $\alpha$  *ALFA* LEGE



- This setting is normally used at the default value.
- This sets the advanced PID constant  $\alpha$ .



| Setting range | Units | Default value |
|---------------|-------|---------------|
| 0.00 to 1.00  | –     | 0.65          |

CH PV tracking *Pvtr* LEGE



- This setting is used to have the local SP track the PV when in manual mode.
- The setting prevents abrupt changes in the MV when switching from manual mode to auto mode.

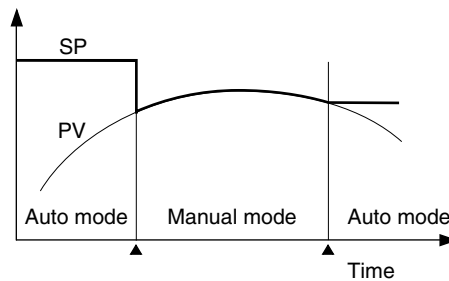

| Setting range              | Units | Default value              |
|----------------------------|-------|----------------------------|
| $\bar{\alpha}FF$ : Disable | –     | $\bar{\alpha}FF$ : Disable |
| $\bar{\alpha}n$ : Enable   |       |                            |

If an input error occurs during PV tracking, the local SP will change to the upper limit of the sensor setting range.

CH

Manual output method

保持

LEUC

Manual MV initial value

保持

This setting is used to specify how the MV is output when switching from auto mode to manual mode.



- When "Hold MV" is selected, the MV at the time of switching is held, after which it can be changed using "Manual MV" (Operation level).
- When "Output default value" is selected, the value specified in "Manual MV default value" is used. This can then be changed using "Manual MV" (Operation level).

Examples of how the MV changes using the two methods are shown below.

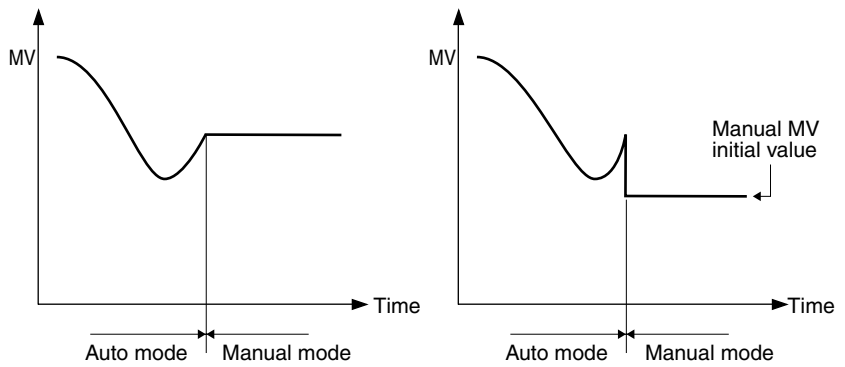

At "MV hold"

At "Initial value output"

| Setting                 | Setting range   | Units | Default value |
|-------------------------|---|-------|---------------|
| Manual output method    | Hold MV : 保持<br>Output initial value: 保持                      | -     | 保持            |
| Manual MV initial value | -5.0 to 105.0 (Standard)<br>-105.0 to 105.0 (Heating/cooling) | %     | 0.0           |



- Related information  
"4.13 Performing manual control" (P.4-29)
- Related setting data  
"Manual MV" (Operation level) (P.8-5)

Setting data



CH

MV change rate limit mode

**MRLN**

**LEGE**



- Use this setting to select Mode 0 or Mode 1 for the MV change rate limit.
- When Mode 1 is selected, the MV change rate limit only functions with respect to increases in the MV.



Setting

| Setting range | Units | Default value |
|---------------|-------|---------------|
| 0: Mode 0     | -     | 0             |
| 1: Mode 1     |       |               |



Reference

- Related information  
"5.2 Control functions ■ PID sets" (P.5-12)
- Related setting data  
"MV change rate limit (heat)", "MV change rate limit (cooling)" (Adjustment level) (P.8-19)

CH

AT calculated gain

**RL-G**

**LEGE**

AT hysteresis

**RL-H**

\* Control mode key: heating/cooling control and position proportional control (floating). During cascade heating/cooling control, only channel 1 is displayed.

Limit cycle MV amplitude

**LCRA\***

Temporary A.T. execution judgement deviation

**TRLE\***



Function

- These settings are normally used at the default values.
- "AT calculated gain" specifies the gain used when PID values are calculated during AT. A smaller gain provides greater adaptability, while a larger gain provides greater stability.
- "AT hysteresis" is used to set the value of hysteresis for ON/OFF switching during the limit cycle while AT is being run.
- "Limit cycle MV amplitude" is used to set the MV amplitude during the limit cycle while AT is being run.
- This is effective when  $P \neq 0.00$  in standard control, or when closed is selected in proportional control.
- "Temporary AT execution judgement deviation" is used to judge if temporary AT is excute or not for running temporary AT. When AT is excuted while, the deviation is greater than the set value, temporary AT runs.



Setting

| Setting                                    | Setting range | Units | Default value |
|--|---------------|-------|---------------|
| AT calculated gain                         | 0.1 to 10.0   | -     | 1.0           |
| AT hysteresis                              | 0.1 to 9.9    | %FS   | 0.2           |
| Limit cycle MV amplitude                   | 5.0 to 50.0   | %     | 20.0          |
| Temporary AT execution judgement deviation | 0.0 to 100.0  | %FS   | 10.0          |



- Related information  
"4.10 Determining the PID constants (AT, manual settings)" (P.4-20)
- Related setting data  
"AT Execute/Cancel" (Adjustment level) (P.8-13)

CH **Bumpless at RUN**      *r b n P*      L.E.U.C



- When "Bumpless at RUN" is enabled, an integral MV correction (bumpless) is performed to prevent abrupt changes in the MV when switching from stop to run.
- Even when the setting is disabled, the bumpless correction is performed when PID values change (including changing the PID set) and when AT ends or is stopped.



| Setting range | Units | Default value |
|---------------|-------|---------------|
| ōFF : Disable | -     | ōFF : Disable |
| ōn : Enable   |       |               |

CH **Operation at potentiometer input error**      *P n E C*      L.E.U.C

Position proportional type  
Closed control



- This setting is used to select whether control is stopped or changed to floating control when a potentiometer error occurs during closed control in position proportional control.



| Setting range | Units | Default value |
|---------------|-------|---------------|
| ōFF : Stop    | -     | ōFF : Stop    |
| ōn : Continue |       |               |



- Related setting data  
"Closed/Floating" (Control initial setting level) (P.8-44)

CH

Disturbance overshoot adjustment function *dōst*

**LEUC**



- This setting is used to enable or disable disturbance overshoot adjustment.



| Setting range        | Units | Default value        |
|----------------------|-------|----------------------|
| <i>dōd</i> : Disable | -     | <i>dōd</i> : Disable |
| <i>dōn</i> : Enable  |       |                      |



- Related information  
"5.2 Control functions ■ Disturbance overshoot adjustment" (P.5-14)

# Section 9 User calibration

|     |  |      |
|-----|--|------|
| 9.1 | Setting data for user calibration .....              | 9-2  |
| 9.2 | User calibration.....                                | 9-4  |
| 9.3 | Thermocouple input calibration .....                 | 9-5  |
| 9.4 | Analog input calibration .....                       | 9-8  |
| 9.5 | Resistance temperature input sensor calibration..... | 9-10 |
| 9.6 | Output calibration.....                              | 9-12 |
| 9.7 | Inspecting indicator accuracy .....                  | 9-13 |

## 9.1 Setting data for user calibration

- To perform user calibration, enter "1201" in "Move to user calibration" in Special setting level. The controller will enter calibration mode and "Adj" will appear in the display.
- If the "Move to user calibration" setting does not appear, set "Initial setting protect" to "0" in Protect level and then move to Special setting level.
- Calibration is ended by turning off the power.
- The setting data for input calibration is shown below.  
(The last digit of Display 1 shows the input number. The example below shows "1" for input 1. In the case of input 2, the display would show "P390.2".)

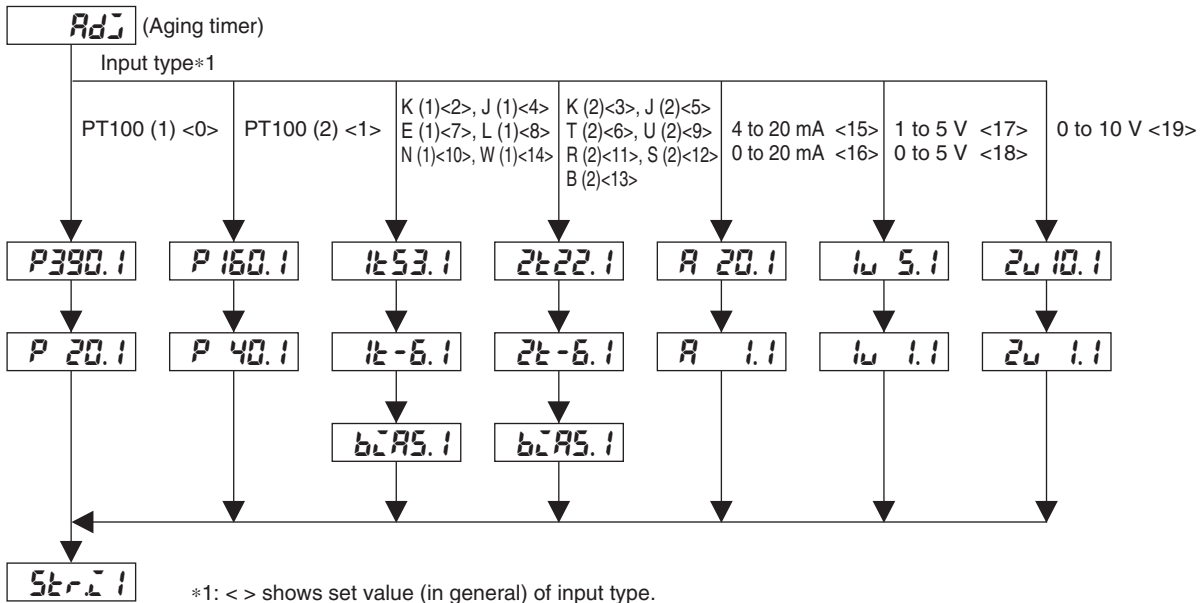

### ◆ Output calibration setting data

The setting data for output calibration is shown below. The display varies depending on the output type of each output.  
(In the following example, the last digit of Display 1 shows "1" for output 1. For output 2, this would be "0AR20.2".)

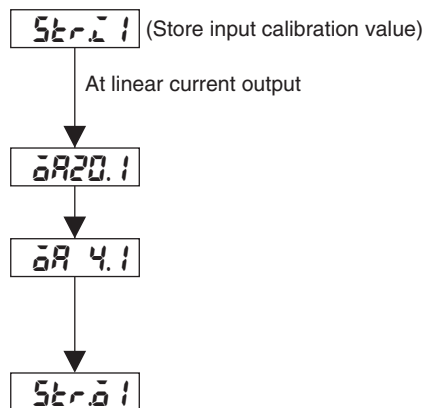

If user calibration was performed on any of inputs 1 to 4 or outputs 1 to 6 following purchase of the controller, user calibration completion information will appear as shown below when you move to Calibration level.

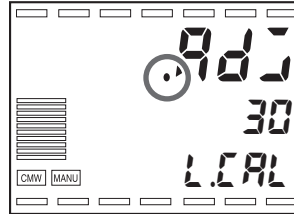

Displays dots

## 9.2 User calibration

The E5AR/ER is calibrated before shipment from the factory and thus there is normally no need for the user to calibrate the controller.

In the event that user calibration is necessary, use the calibration functions for temperature input, analog input, and output that are provide in the controller.

However, note that OMRON cannot ensure the results of calibration by the user.

Also, calibration data is overwritten with the latest settings. The default calibration settings cannot be returned to after user calibration.

### ● Input calibration

The input type selected in the setting data is calibrated. Input types consist of the following 20 types:

- Thermocouple : 13 types
- Analog input : 5 types
- Resistance temperature input sensor : 2 types

### ● Output calibration

The output type selected in the setting data is calibrated. There is only one output type that can be selected:

- Linear current output

### ● Registering calibration data

The new calibration data for each item is temporarily registered. It can be officially registered as calibration data only when all items have been calibrated to new values. So, be sure to temporarily register all items when you calibrate the E5AR/ER.

When calibration data is registered, it is registered regardless of whether or not the E5AR/ER has been calibrated by the user.

Prepare separate measuring devices and equipment for calibration. For details on how to handle measuring devices and equipment, refer to the respective instruction manuals.

## 9.3 Thermocouple input calibration

- Thermocouples are calibrated in two groups according to thermocouple type: Group 1 (input types 2, 4, 7, 8, 10, 14) and Group 2 (input types 3, 5, 6, 9, 11, 12, 13).
- Do not cover the bottom of the thermocouple during calibration. Also, do not touch the input terminal or compensation wire.

### ● Preparations

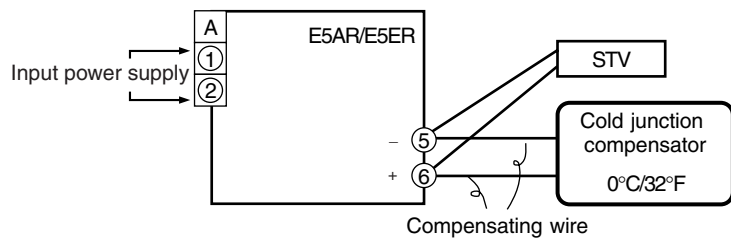

- For the cold junction compensator, use a compensator for calibration of internal thermocouples and set to 0°C. The internal thermocouple should be disabled (tip open).
- STV in the diagram indicates a DC reference current/voltage generator.
- Prepare a compensation wire appropriate for the selected thermocouple. For thermocouples R, S, E, B and W, a cold junction compensator and compensation wire for thermocouple K can be used.



#### Connecting the cold junction compensator

A correct input value cannot be obtained if the compensation wire connector is touched during thermocouple calibration. Therefore, to connect or disconnect the cold junction compensator, short-circuit (enable) or open-circuit (disable) the tip of the thermocouple inside the cold junction compensator, while keeping the compensation wire connected as shown in the diagram.

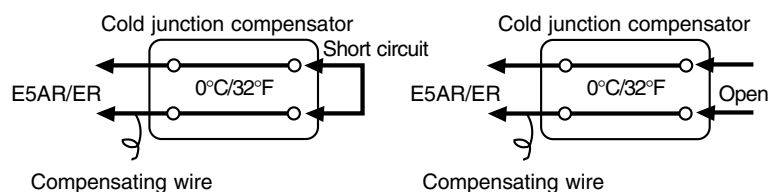



Follow these steps to perform calibration when thermocouple input is selected.

1. Connect the power supply.
2. Connect the DC reference current/voltage generator (STV in the following), precision digital meter (DMM in the following), and cold junction compensator (a ZERO-CON is used as an example in the following) to the input terminals of the thermocouple as shown below.

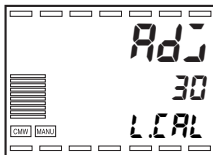
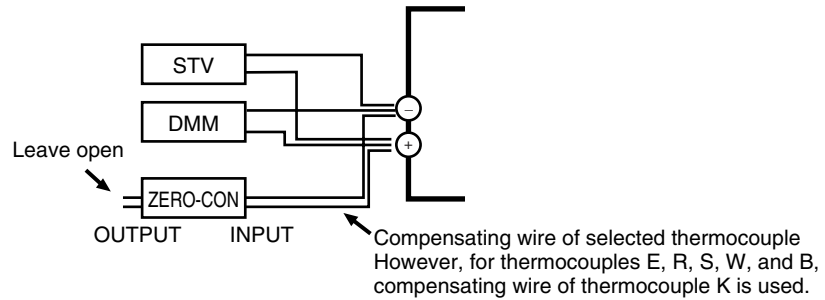

3. Turn on the power.
4. Move to calibration level.  
A 30-minute aging time begins. Perform aging using this time as a guideline. When 30 minutes elapses, Display 2 will show "0".  
Note that you can proceed to the next stop before the display shows "0".

Input types 2, 4, 7, 8, 10, 14

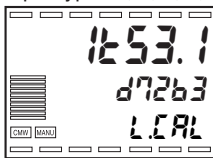

5. Press the key  to obtain the display at left.  
The count value that was input will appear in Display 2 in hexadecimal. Set the STV as follows:
  - For input types 2, 4, 7, 8, 10, and 14: 53 mV
  - For input types 3, 5, 6, 11, 12, and 13: 22 mV

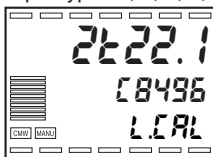

Input types 3, 5, 6, 9, 11, 12, 13



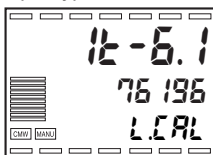

Wait until the count in Display 2 is sufficiently stable and then press the  key. This tentatively saves the calibration data at this point.

Input types 2, 4, 7, 8, 10, 14

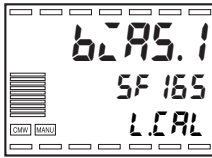

6. Press the key  to obtain the display at left.  
Set the STV to -6 mV.  
Wait until the count in Display 2 is sufficiently stable and then press the  key. This tentatively saves the calibration data at this point.





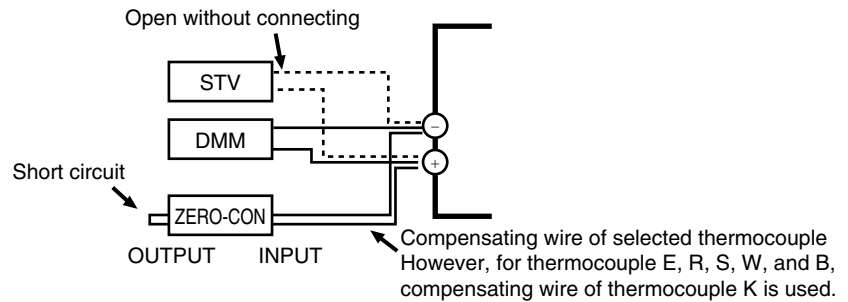



7. Press the key  to obtain the display at left.
8. Change the wiring as shown below.

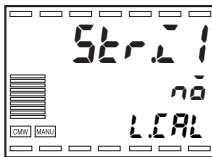

Disconnect the STV and enable the thermocouple in the cold junction compensator. Make sure that the STV is disconnected at this time.

9. Wait until the count in Display 2 is sufficiently stable and then press the  key. This tentatively saves the calibration data at this point.



10. Press the key  to obtain the display at left. Note that this display will not appear if not all of the required data has been tentatively saved. Press the  key. Display 2 will show "YES". Two seconds after the key is released or when the  is pressed, the tentatively saved calibration data is stored in non-volatile memory. If you do not wish to save the data in non-volatile memory, press the  key instead of the  key.
  - For a multi-point input type, connect as explained in step 2 and repeat steps 5 to 10.
  - If linear current output is selected, continue with the procedure explained in "9.6 Output calibration" (P.9-12).

11. Turn off the power to quit calibration mode.

## 9.4 Analog input calibration

Analog input is calibrated in the following groups according to the analog input type: current input group (15, 16), voltage input group 1 (17, 18), and voltage input group 2 (19).

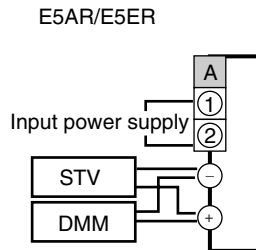

1. Connect the power supply.
2. Connect the STV and DMM to the input terminals of the analog input as shown above.  
Note that different input terminals are used for current input and voltage input. Make sure the connections are correct.
3. Turn on the power.
4. Move to calibration level.  
A 30-minute aging time begins. Perform aging using this time as a guideline. When 30 minutes elapses, Display 2 will show "0".  
Note that you can proceed to the next step before the display shows "0".

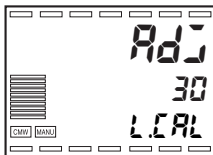

Input types 15 and 16

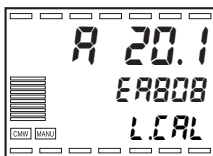

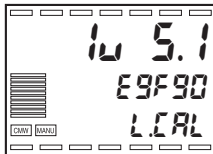

Input types 17 and 18

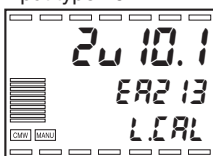

Input type 19



5. Press the key  to obtain the display at left.  
The count value that was input will appear in Display 2 in hexadecimal. Set the STV as follows:
  - For input types 15 and 16: 20 mA
  - For input types 17 and 18: 5 V
  - For input type 19: 10 V

6. Wait until the count in Display 2 is sufficiently stable and then press the  key. This tentatively saves the calibration data at this point.

Input types 15 and 16

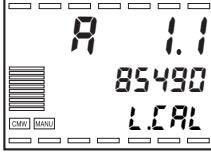

Input types 17 and 18

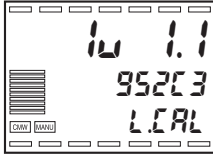

Input type 19

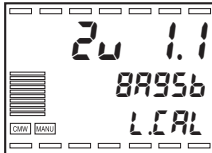



7. Press the key  to obtain the display at left.



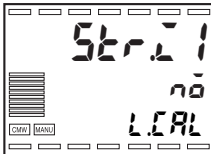

Set the STV as follows:

- Input types 15 and 16: 1 mA
- Input types 17 and 18: 1 V
- Input type 19: 1 V

8. Wait until the count in Display 2 is sufficiently stable and then press the  key. This tentatively saves the calibration data at this point.



9. Press the key  to obtain the display at left. Note that this display will not appear if not all of the required data has been tentatively saved.

Press the  key. Display 2 will show "YES". Two seconds after the key is released or when the  is pressed, the tentatively saved calibration data is stored in non-volatile memory. If you do not wish to save the data in non-volatile memory, press the  key instead of the  key.

- For a multi-point input type, connect as explained in step 2 and repeat steps 5 to 9.
- If linear current output is selected, continue with the procedure explained in "9.6 Output calibration" (P.9-12).

10. Turn off the power to quit calibration mode.

## 9.5 Resistance temperature input sensor calibration

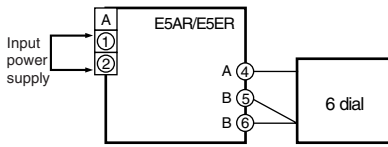

The procedure for calibrating a resistance temperature input sensor is explained in the following.

For the connection wiring, use wiring of the same thickness.

1. Connect the power supply.
2. Connect a precision resistance box (6-dial in the following) to the input terminal of the resistance temperature input sensor as shown at left.
3. Turn on the power.
4. Move to calibration level.

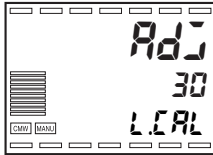

A 30-minute aging time begins. Perform aging using this time as a guideline. When 30 minutes elapses, Display 2 will show "0". Note that you can proceed to the next step before the display shows "0".

Input type 0

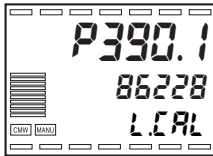

5. Press the key  to display the count value for each input type. At this time the count value that was input will appear in Display 2 in hexadecimal. Set the 6-dial as follows:

- Input type 0: 390  $\Omega$
- Input type 1: 160  $\Omega$

Input type 1

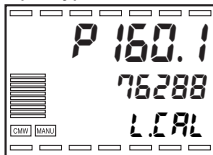

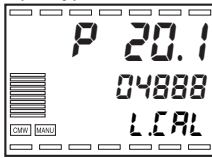

6. Wait until the count in Display 2 is sufficiently stable and then press the  key. This tentatively saves the calibration data at this point.

Input type 0

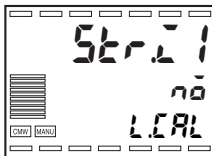
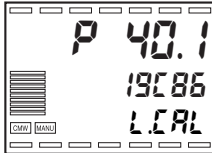

Input type 1







7. Press the  to obtain the display at left.

Set the 6-dial as follows:

- Input type 0: 20  $\Omega$
- Input type 1: 40  $\Omega$

8. Wait until the count in Display 2 is sufficiently stable and then press the  key. This tentatively saves the calibration data at this point.

9. Press the  key to obtain the display at left. Note that this display will not appear if not all of the required data has been tentatively saved.

Press the  key. Display 2 will show "YES". Two seconds after the key is released or when the  is pressed, the tentatively saved calibration data is stored in non-volatile memory. If you do not wish to save the data in non-volatile memory, press the  key instead of the  key.

- For a multi-point input type, connect as explained in step 2 and repeat steps 5 to 9.
- If linear current output is selected, continue with the procedure explained in "9.6 Output calibration" (P.9-12).

10. Turn off the power to quit calibration mode.

## 9.6 Output calibration

- The procedure for calibration when linear current output is selected is explained in the following.
- Output calibration is displayed after input calibration is finished (after the input calibration values are saved). (Perform aging for at least 30 minutes.)

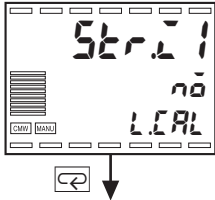

1. The input calibration value save state appears as shown at left.
2. Connect a precision digital meter (DMM in the following) to the output terminal of the linear current output as shown below.

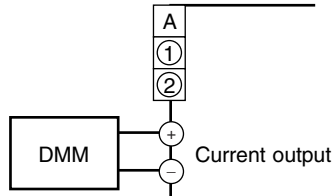

3. Press the key to obtain the display at left and begin 20 mA calibration.

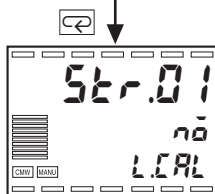
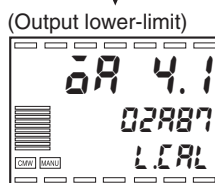
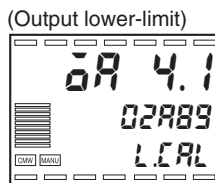
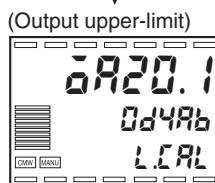
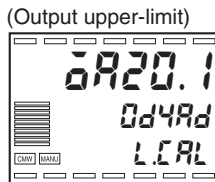

4. While viewing the output on the DMM, use the keys to set the output to 20 mA. In the example at left, "20 mA" appears at a value 2 digits smaller than before calibration.

5. Press the key to obtain the display at left and begin 4 mA calibration.

6. While viewing the output on the DMM, use the keys to set the output to 4mA. In the example at left, "4 mA" appears at a value 2 digits smaller than before calibration.

7. Press the key to obtain the display at left. Note that this display will not appear if not all of the required data has been tentatively saved, or if the data has not been changed.

Press the key. Display 2 will show "SE5". Two seconds after the key is released or when the is pressed, the tentatively saved calibration data is stored in non-volatile memory. If you do not wish to save the data in non-volatile memory, press the key instead of the key.

- If there is another output, connect the output as explained in step 2, and repeat steps 3 to 7.

8. Turn off the power to quit calibration mode.

## 9.7 Inspecting indicator accuracy

- After calibrating input, be sure to inspect the indicator accuracy to verify that the input was calibrated correctly.
- Run the E5AR/ER in the PV/SP state.
- Check the upper limit, lower limit and mid-range limit of the indicator range (3 values).

### ● Thermocouple

#### • Preparations

Connect as follows to the required devices. Be sure to connect the E5AR/ER to the cold junction compensator using the compensation wire that you intend to use for the thermocouple.

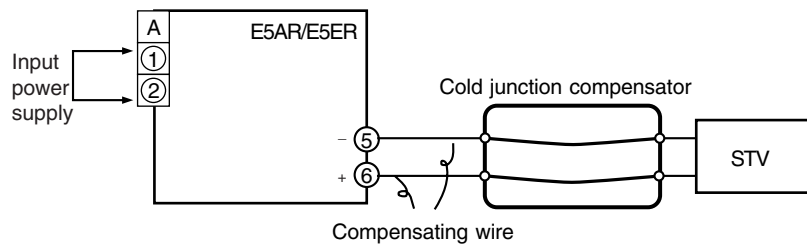

#### • Operation

Make sure that the cold junction compensator is at 0°C, and set the STV output to the voltage that is equivalent to the inspection value startup power.

If the cold junction compensating system is set to external, a cold junction compensator and compensation wire are not needed.

### ● Resistance temperature input sensor

#### • Preparations

Connect as follows to the required devices.

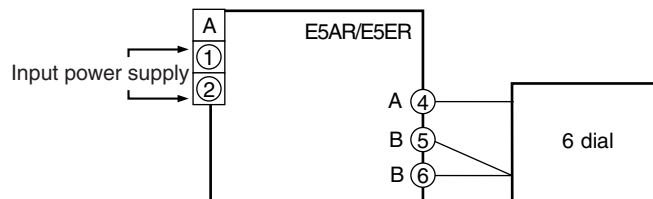

#### • Operation

Set the 6-dial to the resistance that is equivalent to the inspection value.



● Analog input

- Preparations  
Connect as follows to the required devices.

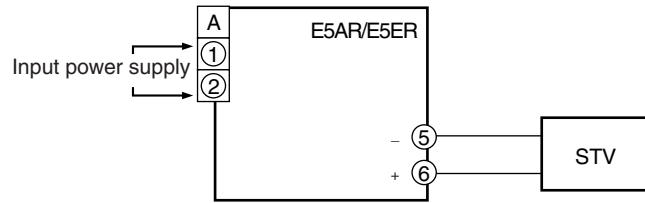

- Operation  
Set the STV output to the inspection value voltage or current.

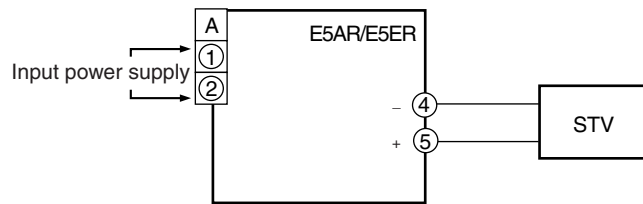

# Section 10 Troubleshooting

|      |  |      |
|------|--|------|
| 10.1 | Troubleshooting checklist.....                                       | 10-2 |
| 10.2 | Error messages .....   | 10-3 |
| 10.3 | Inferring causes from conditions<br>(abnormal measured values) ..... | 10-4 |
| 10.4 | Inferring causes from conditions (abnormal control) .....            | 10-5 |
| 10.5 | Inferring causes from conditions (abnormal output) .....             | 10-7 |
| 10.6 | Inferring causes from conditions<br>(communication problems) .....   | 10-8 |

## 10.1 Troubleshooting checklist

If you encounter difficulty with the controller, use the following checklist to solve the problem.

**Check the display**

Check the operating state of the E5AR/ER as indicated by the display. Error messages and indicators are explained in "10.2 Error messages" (P.10-3). If an error message appears, refer to this section to solve the problem.

**Check switches and wiring**

Check switch settings and wiring

- Power supply
  - Is the power turned on?
  - Are the terminal voltages within the permitted ranges?
- Input type switch
  - Is the switch set to the correct setting for the sensor you are using?
- Wiring
  - Are the terminal connections correct?
  - Are the polarities correct?
  - Are any wires loose?
  - Are any wires or cables broken or not making contact?
- Communication conditions
  - Do the communication conditions match those of the host system?

If you are unable to identify the problem from the above or cannot solve the problem, investigate in more detail.

**Check setting data**

- Are the setting data correct?
- Check for restrictions on the function you are using. See if the cause of the problem lies in your settings.

**Infer from conditions**

If you were not able to identify the cause of the problem by checking the above, refer to the tables in "10.2 Error messages" (P.10-3) and following.

## 10.2 Error messages

When an error occurs, Displays 1 and 2 show error messages.

Refer to the following table to check the meaning of the message and how to solve the problem.

| Display 1      | Display 2                      | Error                              | Solution  | Output state at error  |                                   |
|----------------|--------------------------------|------------------------------------|---|--|-----------------------------------|
|                |                                |                                    |   | Control output   | Alarm output                      |
| Unit           | Err                            | Unit error                         | The unit requires service. Please contact your dealer.  | OFF  | OFF                               |
| Unit           | CHG                            | Unit change                        | Hold down the <input type="checkbox"/> key for at least 5 seconds to store the current unit configuration.<br>If this does not clear the error display, please contact your dealer. | OFF  | OFF                               |
| dLSP           | Err                            | Display unit error                 | Service is required. Please consult your dealer.  | OFF  | OFF                               |
| SYS            | Err                            | Unit error                         |   |  |                                   |
| EEP            | Err                            | Non-volatile memory error          | Hold down the <input type="checkbox"/> key for at least 5 seconds in the error display to initialize. *   | OFF  | OFF                               |
| S.Err          | Normal display                 | Input error                        | Check for an incorrect input connection, broken wire, or short-circuit. Check the input type and input type switch settings.  | MV output according to "MV at PV error" setting.   | "Upper limit exceeded" operation. |
| EEEE           | Normal display                 | Exceeds display range (lower line) | Not an error; however, appears when PV exceeds the display range (-19999 to 99999).   | Normal operation   | Normal operation                  |
| EEEE           |                                | Exceeds display range (upper line) |   |  |                                   |
| Normal display | RSP operation indicator blinks | RSP input error                    | Is the wire connected to the RSP input broken or short-circuited?   | MV at PV error   | OFF                               |
| Normal display | -----                          | Potentiometer input error          | Check the potentiometer wiring.   | When "Closed/Floating" is closed and "operation at potentiometer input error" is OFF, an error MV is output; at all other times, normal operation takes place. | Normal operation                  |
| RLb            | Err                            | Motor calibration error            | Check the wiring to the potentiometer and valve drive motor, and then try motor calibration again.  | OFF  | OFF                               |
| 1-4            | Set value blinks               | Input type switch error            | Set the input type switch for the input you are using so that it accords with the displayed "Input type" setting.   | OFF  | OFF                               |
| 2-4            |                                |                                    |   |  |                                   |
| 3-4            |                                |                                    |   |  |                                   |
| 4-4            |                                |                                    |   |  |                                   |

If the system does not operate as expected after configuring settings, check the wiring and set values once again. If there is still a problem, unintended set values may have been accidentally configured in the setting data. In this case, you can initialize the unit and then re-configure your settings.

\*

### Caution

Initializing the unit will return all settings to the factory default settings. The factory default settings may cause unexpected output, so disconnect all output wires and eliminate effects to the system before initializing the unit. In addition, write down your settings prior to initialization.

## 10.3 Inferring causes from conditions (abnormal measured values)

### ● The measured value is abnormal or measurement is not possible

|               | Possible cause  | Solution  |
|---------------|---|---|
| Connections   | The polarity or connections to the temperature sensor are not correct.  | Connect the wires correctly.  |
|               | A temperature sensor that cannot be used with the E5AR/ER is connected.   | Change to a temperature sensor that can be used with the E5AR/ER.   |
|               | The temperature sensor has a broken wire, a short-circuit, or has deteriorated.   | Replace the temperature sensor.   |
|               | A temperature sensor is not connected.  | Connect a temperature sensor.   |
|               | A compensation wire compatible with the thermocouple is not being used.   | <ul style="list-style-type: none"> <li>• Directly connect a thermocouple with a long lead.</li> <li>• Use a compatible compensation wire.</li> </ul>  |
|               | A metal device other than the thermocouple or compensation wire is connected between the terminals of the E5AR/ER and thermocouple. | Connect with a device that is designed for use with thermocouples.  |
|               | The terminal connection screws are loose, resulting in a bad connection.  | Tighten the screws securely.  |
|               | The lead or compensation wire of the thermocouple is too long and gives rise to resistance effects.                                 | <ul style="list-style-type: none"> <li>• Use a thick compensation wire.</li> <li>• Change the wiring and locations to allow shorter lengths.</li> </ul>   |
|               | The 3 wires between the terminals of the E5AR/ER and the platinum resistance temperature input sensor have different resistances.   | Use wires of the same resistance for terminals A, B, and B.   |
| Installation  | The E5AR/ER is receiving noise from peripheral devices.   | <ul style="list-style-type: none"> <li>• Separate the E5AR/ER from noise-emitting devices.</li> <li>• Install a surge absorber or noise filter in noise-emitting devices.</li> </ul>  |
|               | The lead and power line of the temperature sensor are too close and induction noise is received from the power line.                | <ul style="list-style-type: none"> <li>• Separate the lead from the power line.</li> <li>• Run the lead and power line through separate conduits or ducts.</li> <li>• Do not wire the lead in parallel with the power line.</li> <li>• Change the wiring to allow a shorter lead.</li> <li>• Use shielded wire for the lead.</li> </ul> |
|               | The mounting location of the temperature sensor is too far from the point of control and the thermal response is slow.              | Mount the sensor so that the tip of the protective tubing approaches the point of control.  |
|               | The ambient operating temperature of the E5AR/ER exceeds the rated temperature.   | Keep the ambient operating temperature within the rated range: -10 to 55°C.   |
|               | Wireless devices are used near the E5AR/ER.   | Shield the E5AR/ER.   |
|               | The temperature of the terminal plate is not uniform due to heat dissipation from peripheral devices.                               | Install the E5AR/ER in a location where it is not exposed to heat dissipation.  |
|               | The terminal plate of the E5AR/ER is exposed to strong air flow.  | Prevent air flow from blowing on the terminal plate.  |
| Settings      | The input type switch setting is not correct.   | Set the input type switch to the correct setting for the input.   |
|               | The input type setting is not correct.  | Set the correct input type.   |
|               | The temperature units setting is not correct.   | Set the correct temperature units.  |
|               | The measured temperature appears to deviate after setting an input shift value.   | Set the input shift value to "0.0".   |
|               | The units of a data setting are not correct.  | Correct the host system program.  |
|               | The host system program is not correct.   |   |
| Method of use | The input terminal for thermocouple input is short-circuited.   | Connect the thermocouple.   |
|               | A temperature sensor was replaced or a switch setting was changed while the power was on.   | Turn the power off and then on.   |

#### Supplement

Simple method for checking input:

Platinum resistance temperature input sensor:

- 1) Connect a 100 Ω resistor between input terminals A-B and short-circuit B-B.
- 2) If the measured temperature is approximately 0.0°C or 32.0°F, the E5AR/ER is operating normally.

Thermocouple: 1) Short-circuit the input terminal of the temperature sensor.

- 2) If the temperature close to the terminal plate can be measured, the E5AR/ER is operating normally.

Analog input: Use a STV to supply the specified current or voltage and verify.

## 10.4 Inferring causes from conditions (abnormal control)

### ● The PV does not rise

|             | Possible cause   | Solution   |
|-------------|--|--|
| Connections | Abnormal measured value.   | Solve as explained in section 10.3.  |
|             | A load is not connected to the control output terminal.                  | Connect a load.  |
|             | Incorrect load polarity or incorrect terminal connections.               | Wire correctly.  |
|             | The terminal connection screws are loose, resulting in a bad connection. | Tighten the screws securely.   |
|             | The heater power is not turned on.                                       | Turn on the heater power.  |
|             | The heater has a broken wire or has deteriorated.                        | Replace the heater.  |
|             | The heater has a low heat capacity.                                      | <ul style="list-style-type: none"> <li>• Change to a heater with a high heat capacity.</li> <li>• If using two or more heaters, replace any heaters that have broken wires.</li> </ul> |
|             | The overheating prevention device has activated.                         | Increase the temperature setting of the overheating prevention device to a value higher than the SP of the E5AR/ER.  |
| Settings    | Direct action and reverse action settings are incorrect.                 | Set the correct settings.  |
|             | The PID values are not suitable.   | <ul style="list-style-type: none"> <li>• Run AT.</li> <li>• Set suitable PID values.</li> </ul>  |
|             | Control has not been started.  | Start control.   |
|             | The output does not increase due to MV limits.                           | Change the output limits to suitable values.   |
|             | The cooling fan is running.  | Stop the cooling fan.  |

### ● The measured value rises above the SP

|               | Possible cause  | Solution  |
|---------------|---|---|
| Connections   | Abnormal measured value.  | See section 10.3.   |
|               | The load is connected to the wrong channel and the heater is being controlled by the control output of another channel. | Wire correctly.   |
|               | The contact of the control output drive relay has melted.   | Replace the relay.  |
|               | Short-circuit failure in SSR.   | Replace the SSR.  |
|               | Current flows to heater due to SSR leakage current.   | Connect a bleeder resistor to prevent action due to leakage current.                            |
| Settings      | Direct action and reverse action settings are incorrect.  | Set the correct settings.   |
|               | The PID values are not suitable.  | <ul style="list-style-type: none"> <li>• Run AT.</li> <li>• Set suitable PID values.</li> </ul> |
|               | The output does not decrease due to MV limits.  | Change the output limits to suitable values.  |
|               | Output is taking place in manual mode.  | Stop manual mode.   |
| Method of use | The object of control generates heat.   | Use heating/cooling control.  |
|               | Large overshoot.  | See the "Overshoot or undershoot" troubleshooting table.  |

### ● Overshoot or undershoot occurs

|             | Possible cause   | Solution   |
|-------------|--|--|
| Connections | Abnormal measured value.   | See section 10.3.  |
|             | A regular slow thermal response temperature sensor is connected to a fast thermal response control system. | Change to a sheath-type temperature sensor.  |
| Settings    | The proportional band is too narrow; the P value is too small.   | <ul style="list-style-type: none"> <li>• Increase the P value within the limit that the response speed does not become too slow.</li> <li>• Run AT.</li> </ul>         |
|             | The integral time is too short; the I value is too small.  | <ul style="list-style-type: none"> <li>• Increase the I value within the limit that the response speed does not become too slow.</li> <li>• Run AT.</li> </ul>         |
|             | The derivative time is too short; the D value is too small.  | <ul style="list-style-type: none"> <li>• Increase the D value within the limit that stability during rectification does not deteriorate.</li> <li>• Run AT.</li> </ul> |
|             | ON/OFF control is being performed.   | Use P control or PID control.  |
|             | The control period is too long in a fast thermal response control system.                                  | Shorten the control period.  |
|             | Overlap band is mistakenly set as a dead band in heating/cooling control.                                  | Set to overlap band.   |

### ● Hunting occurs

Check connections and settings as explained above in "Overshoot or undershoot occurs".

|               | Possible cause   | Solution  |
|---------------|--|---|
| Method of use | The heat capacity of the heater is too large for the heat capacity of the object of control. | Use a heater with a heat capacity suitable for the object of control. |
|               | Periodic disturbances occur that cause the heat capacity of the object of control to change. | Establish an environment with minimal disturbances.                   |
|               | AT is running.   | Hunting will stop when AT ends.                                       |

## 10.5 Inferring causes from conditions (abnormal output)

### ● No control output. No alarm output.

|  | Possible cause   | Solution   |
|--|--|--|
| Connections  | Abnormal temperature measurement.  | See "10.3 Inferring causes from conditions (abnormal measured values)" (P.10-4).   |
|  | Incorrect load polarity or incorrect terminal connections.                                   | Wire correctly.  |
|  | The connected load exceeds the output rating.  | <ul style="list-style-type: none"> <li>Do not exceed the rating.</li> <li>Repair in the event of a failure.</li> </ul>   |
|  | A load power supply is not connected to a transistor output.                                 | Use a power supply suitable for the output rating and load.  |
|  | The polarity of the load power supply connected to the transistor output is incorrect.       | Wire correctly.  |
| Settings   | Operation is stopped after the power is turned on.   | <ul style="list-style-type: none"> <li>Send the control start (run) command after turning on the power.</li> <li>Set operation to continue at power-on.</li> </ul> |
|  | Control has not been started.  | Send the control start (run) command.  |
|  | The wrong channel is specified.  | Set the correct channel number.  |
|  | The wrong SP is set.   | Set the correct SP.  |
|  | The wrong bank No. is specified.   | Set the correct bank No.   |
|  | When bank No. specification is by event input, input ON or OFF is not held.                  | Hold the contact ON or OFF during specification.   |
|  | When bank No. specification is by event input, specification by communication was attempted. | The latest specification takes priority regardless of the bank No. specification method.   |
|  | The alarm mode is set to "0: No alarm".  | Set the correct alarm mode.  |
|  | Alarm with wait sequence is specified.   | Specify an alarm without a wait sequence.  |
| Deviation alarm is mistakenly set for absolute-value alarm, or vice-versa. | Set the correct alarm mode.  |  |



## 10.6 Inferring causes from conditions (communication problems)

### ● Cannot communicate. No response.

|                          | Possible causes   | Solution   |
|--------------------------|---|--|
| Communication conditions | The communications speed differs from the host system.  | Make sure that the communications speeds are the same.   |
|                          | The communication conditions are different from the host system.  | Make sure that the communication conditions are the same.  |
| Connections              | The number of parallel connections exceeds the rating.  | Do not exceed the rating.<br>• For RS-485, a maximum of 31 units can be connected.   |
|                          | The length of the communication path exceeds the rating.  | Do not exceed the rating.<br>• For RS-485, the total maximum length is 500 m.  |
|                          | Another unit has the same unit number.  | Make sure there are no duplicate unit numbers.   |
|                          | Noise is corrupting the communication data.   | <ul style="list-style-type: none"> <li>• Separate the communication cable from the noise source.</li> <li>• Use shielded communication cable.</li> <li>• Use an optical interface.</li> <li>• Have the program resend the command when a problem is detected in the response.</li> </ul> |
|                          | Incorrect use of communication devices:<br>• Optical interface<br>• 232C-485 converter                    | Verify the method of use in the literature for each device.  |
|                          | Incorrect installation of RS-485 terminators.   | Install terminators only on the devices on the ends of the communication path.   |
| Program                  | Communication begins as soon as the power of the E5AR/ER is turned on.                                    | Wait at least 2 seconds before beginning communication after the power is turned on.   |
|                          | Unstable signals that occur when the E5AR/ER is turned on or off are read as host system data.            | Initialize the host system reception buffer at the following times:<br>• Before sending the first command.<br>• After the power of the E5AR/ER is turned off.  |
|                          | The host system sends a command before receiving a response from the E5AR/ER.                             | Ensure that the program always reads the response after sending a command.   |
|                          | The interval between receiving a response and sending the next command from the host system is too short. | Allow an interval of at least 5 ms after receiving a response before sending a command.  |
|                          | Mistake in host system program.   | <ul style="list-style-type: none"> <li>• Correct the program.</li> <li>• Check the command in the line monitor.</li> <li>• Try running a sample program.</li> </ul>  |
| Settings                 | The unit number setting is different from the unit number specified in the command.                       | Make sure the unit numbers match.  |

# *Appendix*

|  |      |
|--|------|
| Specifications.....  | A-2  |
| Sensor input setting ranges · Indicator (control) ranges ..... | A-4  |
| ASCII Codes .....  | A-5  |
| Setting list .....   | A-6  |
| Setting data list .....  | A-30 |

# Specifications

## ■ Unit ratings

|                                    |  |   |
|------------------------------------|--|---|
| Power supply voltage <sup>*1</sup> | 100 to 240 V AC 50/60 Hz   | 24 V DC 50/60 Hz/24 V DC  |
| Allowed voltage variance range     | 85 to 110% of rating voltage   |   |
| Power consumption                  | E5AR: 22 VA max.<br>E5ER: 17 VA max.   | E5AR: 15 VA/10 W max.<br>E5ER: 11 VA/7 W max.   |
| Sensor input <sup>*2</sup>         | Thermocouples: K, J, T, E, L, U, N, R, S, B, W<br>Platinum resistance temperature input sensors: Pt100<br>Current input: 4 to 20 mA DC, 0 to 20 mA DC (including remote SP input)<br>Voltage input: 1 to 5 V DC, 0 to 5 V DC, 0 to 10 V DC (including remote SP input)<br>(Input impedance: 150 Ω using current input, approx. 1 MΩ using voltage input) |   |
| Control output                     | Voltage (pulse) output   | 12 V DC, 40 mA max. <sup>*3</sup> , with short-circuit protection circuit   |
|                                    | Current output   | 0 to 20 mA DC/4 to 20 mA DC 500 Ω load max. (including transfer output)<br>(Resolution: Approx. 54000 at 0 to 20 mA DC, approx. 43000 at 4 to 20 mA DC) |
|                                    | Relay output   | Position proportional control type (open, close)<br>1a 250 V AC 1 A (including inrush current) (inductive load)   |
| Auxiliary output                   | Relay output   | 1a 250 V AC 1 A (resistive load)  |
|                                    | Transistor output  | Maximum load voltage 30 V DC, maximum load current 50 mA<br>Residual voltage 1.5 V max., leakage current 0.4 mA max.                                    |
| Event input                        | Contact  | Input ON: 1 kΩ max., OFF: 100 kΩ max.   |
|                                    | Non-contact  | Input ON: Residual voltage 1.5 V max., OFF: Leakage current 0.1 mA max.   |
|                                    | Short-circuit current: Approx. 4 mA  |   |
| Remote SP input                    | See "Sensor input"   |   |
| Potentiometer input                | 100 Ω to 2.5 kΩ  |   |
| Transfer output                    | See "Control output"   |   |
| Control method                     | Advanced PID or ON/OFF   |   |
| Setting method                     | Digital setting by front panel keys, setting by communication  |   |
| Indicator method                   | 7-segment digital display and LED indicators<br>E5AR: Character height PV 12.8 mm, SV 7.7 mm, MV 7.7 mm<br>E5ER: Character height PV 9.5 mm, SV 7.2 mm, MV 7.2 mm  |   |
| Other functions                    | Varies by model  |   |
| Ambient operating temperature      | -10 to +55°C (no condensation or ice formation) / 3 year warranty: -10 to +50°C  |   |
| Ambient operating humidity         | Relative humidity 25 to 85%  |   |
| Storage temperature                | -25 to +65°C (no condensation or icing)  |   |

\*1 100 to 240V AC and 24 V AC/DC are on different models. Please specify when ordering.

\*2 Multi-input. Switch between temperature and analog input by input type switch.  
Basic insulation between power supply – input terminals, power supply – output terminals.

\*3 The voltage output for E5AR-QQ□□□WW-□□□ is 21 mA max.

## ■ Unit performance specifications

|                                    |  |  |
|------------------------------------|--|--|
| Indication accuracy                | Thermocouple input:<br>( $\pm 0.1\%$ of indication value or $\pm 1^\circ\text{C}$ , whichever is greater) $\pm 1$ digit max. *1<br>[Not using internal cold contact compensation]<br>( $+0.1\%$ of indication value or $\pm 1^\circ\text{C}$ , whichever is smaller) $\pm 1$ digit max. *2<br>Analog input: (0.1% FS) $\pm 1$ digit max.<br>Platinum resistance temperature sensor input:<br>( $\pm 0.1\%$ of indication value or $\pm 0.5^\circ\text{C}$ , whichever is greater) $\pm 1$ digit max.<br>Position proportional potentiometer input:<br>( $\pm 5\%$ FS) $\pm 1$ digit max. |  |
| Temperature variation influence *3 | Thermocouple input (R, S, B, W):<br>( $\pm 1\%$ of PV or $\pm 10^\circ\text{C}$ , whichever is greater) $\pm 1$ digit max.<br>Other thermocouple input:<br>( $\pm 1\%$ of PV or $\pm 4^\circ\text{C}$ , whichever is greater) $\pm 1$ digit max.<br>*K thermocouple at $-100^\circ\text{C}$ max: $\pm 10^\circ\text{C}$ max.   |  |
| Voltage variation influence *3     | Platinum resistance thermometer:<br>( $\pm 1\%$ of PV or $\pm 2^\circ\text{C}$ , whichever is greater) $\pm 1$ digit max.<br>Analog input: ( $\pm 1\%$ FS) $\pm 1$ digit max.  |  |
| Control mode                       | Standard control (heating control or cooling control), heating/cooling control<br>Standard control with remote SP (2-input type only)<br>Heating/cooling control with remote SP (2-input type only)<br>Cascade standard control (2-input type only)<br>Cascade heating/cooling control (2-input type only)<br>Ratio control (2-input type only)<br>Position proportional control (control valve control type only)   |  |
| Control period                     | 0.2 to 99.0 seconds (units of 0.1 seconds): During time-divided proportional control output  |  |
| Proportional band (P)              | 0.00 to 999.99% FS (units of 0.01% FS)   |  |
| Integral time (I)                  | 0.0 to 3999.9 s (units of 0.1 second)  |  |
| Derivative time (D)                | 0.0 to 3999.9 s (units of 0.1 second)  |  |
| Hysteresis                         | 0.01 to 99.99% FS (units of 0.01% FS)  |  |
| Manual reset value                 | 0.0 to 100.0% (units of 0.1% FS)   |  |
| Alarm setting range                | $-19999$ to $99999$ *4<br>(Decimal point position depends on input type and decimal point position setting)  |  |
| Input sampling period              | 50 ms  |  |
| Insulation resistance              | 20 M $\Omega$ or higher (using 500 V DC insulation resistance tester)  |  |
| Voltage resistance                 | 2000 V AC 50/60 Hz 1 min (different pole, charging terminals)  |  |
| Vibration tolerance                | Vibration frequency: 10 to 55 Hz<br>Acceleration: 20 m/s <sup>2</sup>  |  |
| Shock tolerance                    | 150 m/s <sup>2</sup> (relay contacts: 100 m/s <sup>2</sup> )<br>3 times each in 3 axes and 6 directions  |  |
| Inrush current                     | 100 to 240 V AC type: 50 A max.<br>24 V AC/DC type: 30 A max.  |  |
| Weight                             | E5AR   | Approx. 450 g (unit only), Fittings: Approx. 60 g,<br>Terminal cover: Approx. 30 g |
|                                    | E5ER   | Approx. 330 g (unit only), Fittings: Approx. 60 g,<br>Terminal cover: Approx. 16 g |
| Protective structure               | Front: IP66, rear case: IP20, terminal plate: IP00   |  |
| Memory protection                  | Non-volatile memory (Write count:100,000 times)  |  |

\*1 K, T, N at  $-100^\circ\text{C}$  max.:  $\pm 2^\circ\text{C}$   $\pm 1$  digit max..  
 U and L:  $\pm 2^\circ\text{C}$   $\pm 1$  digit max..  
 B at  $400^\circ\text{C}$  max. is not specified.  
 R and S at  $200^\circ\text{C}$  max.:  $\pm 3^\circ\text{C}$   $\pm 1$  max..  
 W: (Larger of  $\pm 0.3\%$ PV and  $\pm 3^\circ\text{C}$ )  $\pm 1$  digit max..

\*2 U and L:  $\pm 1^\circ\text{C}$   $\pm 1$  digit  
 R and S at  $200^\circ\text{C}$  max.:  $\pm 1.5^\circ\text{C}$   $\pm 1$  digit.

\*3 Ambient temperature:  $-10^\circ\text{C}$  to  $23^\circ\text{C}$  to  $55^\circ\text{C}$   
 Voltage range:  $-15\%$  to  $+10\%$  of rated voltage

\*4 EU stands for "Engineering Units" and is regarded as the units after scaling. In the case of a temperature sensor, this is  $^\circ\text{C}$  or  $^\circ\text{F}$ .

## Sensor input setting ranges · Indicator (control) ranges

| Input type                             | Specification   | Setting value              | Input setting range  |                   | Display (control) range  |                    |
|--|---|----------------------------|--|-------------------|--|--------------------|
|  |   |                            | °C   | °F                | °C   | °F                 |
| Platinum resistance temperature sensor | Pt100   | 0                          | -200.0 to 850.0  | -300.0 to 1500.0  | -305.0 to 955.0  | -480.0.0 to 1680.0 |
|  | Pt100   | 1                          | -150.00 to 150.00  | -199.99 to 300.00 | -180.00 to 180.00  | -249.99 to 350.00  |
| Thermocouple                           | K   | 2                          | -200.0 to 1300.0   | -300.0 to 2300.0  | -350.0 to 1450.0   | -560.0 to 2560.0   |
|  | K   | 3                          | -20.0 to 500.0   | 0.0 to 900.0      | -72.0 to 552.0   | -90.0 to 990.0     |
|  | J   | 4                          | -100.0 to 850.0  | -100.0 to 1500.0  | -195.0 to 945.0  | -260.0 to 1660.0   |
|  | J   | 5                          | -20.0 to 400.0   | 0.0 to 750.0      | -62.0 to 442.0   | -75.0 to 825.0     |
|  | T   | 6                          | -200.0 to 400.0  | -300.0 to 700.0   | -260.0 to 460.0  | -400.0 to 800.0    |
|  | E   | 7                          | 0.0 to 600.0   | 0.0 to 1100.0     | -60.0 to 660.0   | -110.0 to 1210.0   |
|  | L   | 8                          | -100.0 to 850.0  | -100.0 to 1500.0  | -195.0 to 945.0  | -260.0 to 1660.0   |
|  | U   | 9                          | -200.0 to 400.0  | -300.0 to 700.0   | -260.0 to 460.0  | -400.0 to 800.0    |
|  | N   | 10                         | -200.0 to 1300.0   | -300.0 to 2300.0  | -350.0 to 1450.0   | -560.0 to 2560.0   |
|  | R   | 11                         | 0.0 to 1700.0  | 0.0 to 3000.0     | -170.0 to 1870.0   | -300.0 to 3300.0   |
|  | S   | 12                         | 0.0 to 1700.0  | 0.0 to 3000.0     | -170.0 to 1870.0   | -300.0 to 3300.0   |
|  | B   | 13                         | 100.0 to 1800.0  | 300.0 to 3200.0   | -70.0 to 1970.0  | -10.0 to 3490.0    |
| W                                      | 14  | 0.0 to 2300.0              | 0.0 to 4100.0  | -230.0 to 2530.0  | -410.0 to 4510.0   |                    |
| Analog input                           | 4 to 20 mA<br>0 to 20 mA<br>1 to 5 V<br>0 to 5 V<br>0 to 10 V | 15<br>16<br>17<br>18<br>19 | One of following ranges depending on scaling:<br>-19999 to 99999<br>-1999.9 to 9999.9<br>-199.99 to 999.99<br>-19.999 to 99.999<br>-1.9999 to 9.9999 |                   | -10 to 110% of setting range<br>Maximum range: -19999 to 99999 |                    |

- Applicable input type standards are as follows:  
 K, J, T, E, N, R, S, B : JIS C1602-1995  
 L : Fe-CuNi, DIN43710-1985  
 U : Cu-CuNi, DIN43710-1985  
 W : W5Re/W26Re, ASTM E988-1990  
 Pt100 : JIS C1604-1997, ICE751

# ASCII Codes

| Upper<br>Lower | 0   | 1   | 2     | 3 | 4 | 5 | 6 | 7   |
|----------------|-----|-----|-------|---|---|---|---|-----|
| 0              | NUL | DLE | SPACE | 0 | @ | P | ` | p   |
| 1              | SOH | DC1 | !     | 1 | A | Q | a | q   |
| 2              | STX | DC2 | “     | 2 | B | R | b | r   |
| 3              | ETX | DC3 | #     | 3 | C | S | c | s   |
| 4              | EOT | DC4 | \$    | 4 | D | T | d | t   |
| 5              | ENQ | NAK | %     | 5 | E | U | e | u   |
| 6              | ACK | SYN | &     | 6 | F | V | f | v   |
| 7              | BEL | ETB | ‘     | 7 | G | W | g | w   |
| 8              | BS  | CAN | (     | 8 | H | X | h | x   |
| 9              | HT  | EM  | )     | 9 | I | Y | i | y   |
| A              | LF  | SUB | *     | : | J | Z | j | z   |
| B              | VT  | ESC | +     | ; | K | [ | k | {   |
| C              | FF  | FS  | ,     | < | L | ¥ | l |     |
| D              | CR  | GS  | -     | = | M | ] | m | }   |
| E              | SO  | RS  | .     | > | N | ^ | n | ~   |
| F              | SI  | US  | /     | ? | O | _ | o | DEL |

## Setting list

The setting list shows addresses for CompoWay/F communication and Modbus communication. Refer to the addresses of the protocol that you are using.

The hexadecimal values in the Setting (monitor) value column are the setting ranges in CompoWay/F and Modbus, and the values in parentheses ( ) are the actual setting ranges.

The monitor and setting values can be specified for each channel, and addresses include a channel identifier. The addresses in the variable area map are for channel 1. To specify addresses of other channels on a multi-point input type, refer to the table below.

| Channel | Address                                    |  |
|---------|--|--|
|         | CompoWay/F                                 | ModBus                                     |
| 1       | Address in setting list in Appendix        | Address in setting list in Appendix        |
| 2       | Address in setting list in Appendix + 0100 | Address in setting list in Appendix + 4000 |
| 3       | Address in setting list in Appendix + 0200 | Address in setting list in Appendix + 8000 |
| 4       | Address in setting list in Appendix + 0300 | Address in setting list in Appendix + C000 |

"H" "-" indicated in set values (monitor values) are values set by communication (monitor).

### Communication monitor setting (C0 to C1)

| Variable type | CompoWay/F Address | Modbus Address | Setting data                | Attributes | Character | Setting (monitor) value   | Character                     | Default value | Decimal point position  | Units |
|---------------|--------------------|----------------|-----------------------------|------------|-----------|---|-------------------------------|---------------|-------------------------|-------|
| C0            | 0000               | 0000           | Present Value(PV)           | CH         | -         | According to specified input range  | -                             | -             | According to input type | EU    |
|               | 0001               | 0002           | Status                      | CH         | -         | Refer to following section.   | -                             | -             | -                       | -     |
|               | 0002               | 0004           | SP                          | CH         | -         | SP setting lower limit to SP setting upper limit  | -                             | -             | According to input type | EU    |
|               | 0004               | 0008           | MV monitor (heat)           | CH         | Ⓜ         | Standard: H'FFFFFFE to H'0000041A (-5.0 to 105.0)<br>Heat/cool: H'00000000 to H'0000041A (0.0 to 105.0) | -5.0 to 105.0<br>0.0 to 105.0 | -             | 1                       | %     |
| C1            | 0005               | 000A           | MV monitor (cool)           | CH         | ℄ - Ⓜ     | H'00000000 to H'0000041A (0.0 to 105.0)   | 0.0 to 105.0                  | -             | 1                       | %     |
|               | 0003               | 0106           | SP *1                       | CH         | -         | SP setting lower limit to SP setting upper limit  | Same as at left               | 0             | According to input type | EU    |
|               | 0004               | 0108           | Bank 0: Alarm value 1       | CH         | Ⓜ.℄ - ℄   | H'FFFFB1E1 to H'0001869F (-19999 to 99999)  | -9999 to 99999                | 0             | According to input type | EU    |
|               | 0005               | 010A           | Bank 0: Alarm upper limit 1 | CH         | Ⓜ.℄.℄     | H'FFFFB1E1 to H'0001869F (-19999 to 99999)  | -9999 to 99999                | 0             | According to input type | EU    |
|               | 0006               | 010C           | Bank 0: Alarm lower limit 1 | CH         | Ⓜ.℄.℄     | H'FFFFB1E1 to H'0001869F (-19999 to 99999)  | -9999 to 99999                | 0             | According to input type | EU    |
|               | 0007               | 010E           | Bank 0: Alarm value 2       | CH         | Ⓜ.℄ - ℄   | H'FFFFB1E1 to H'0001869F (-19999 to 99999)  | -9999 to 99999                | 0             | According to input type | EU    |
|               | 0008               | 0110           | Bank 0: Alarm upper limit 2 | CH         | Ⓜ.℄.℄     | H'FFFFB1E1 to H'0001869F (-19999 to 99999)  | -9999 to 99999                | 0             | According to input type | EU    |
|               | 0009               | 0112           | Bank 0: Alarm lower limit 2 | CH         | Ⓜ.℄.℄     | H'FFFFB1E1 to H'0001869F (-19999 to 99999)  | -9999 to 99999                | 0             | According to input type | EU    |

\*1 .... Local SP of bank number selected for execution.



Status (E5□R) (Communication/CompoWay/F)

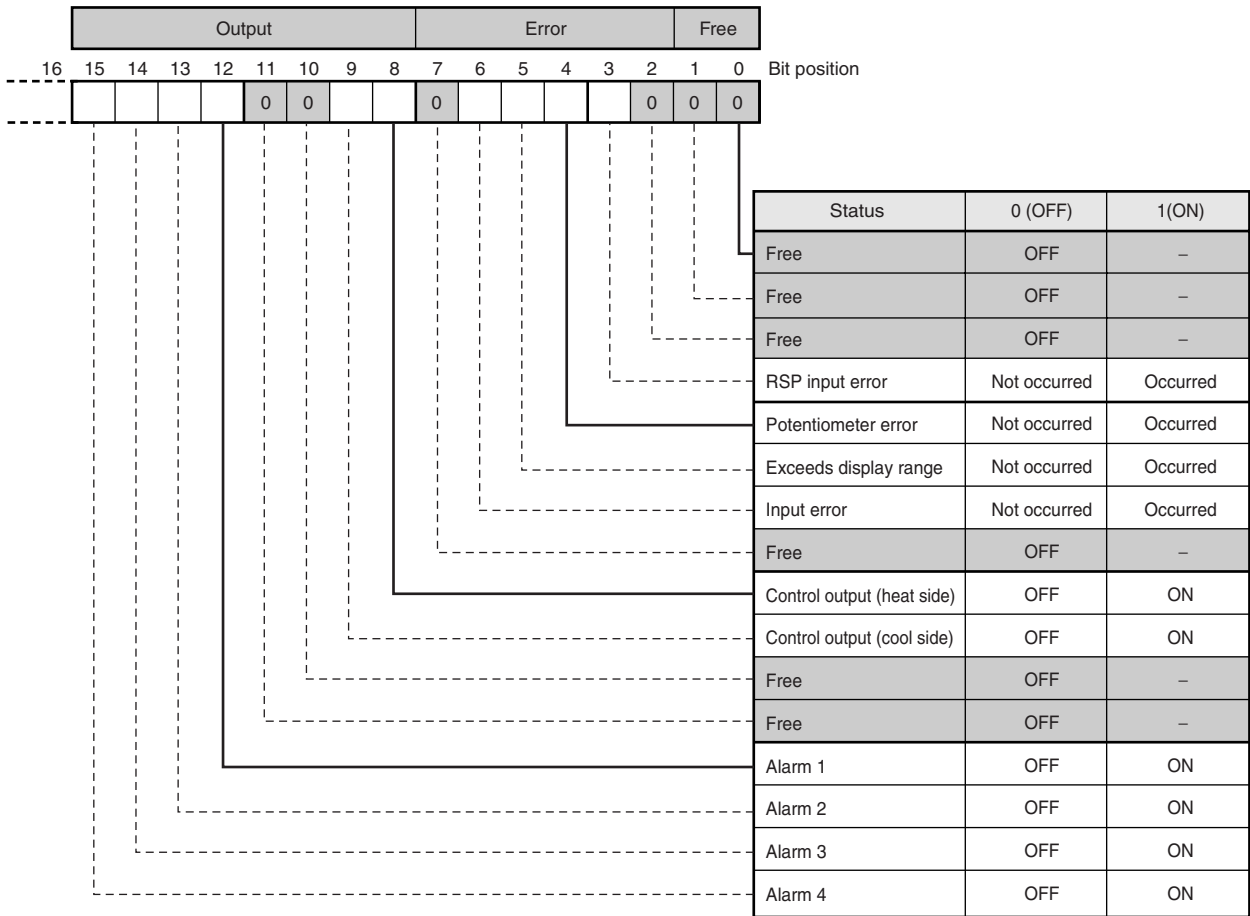

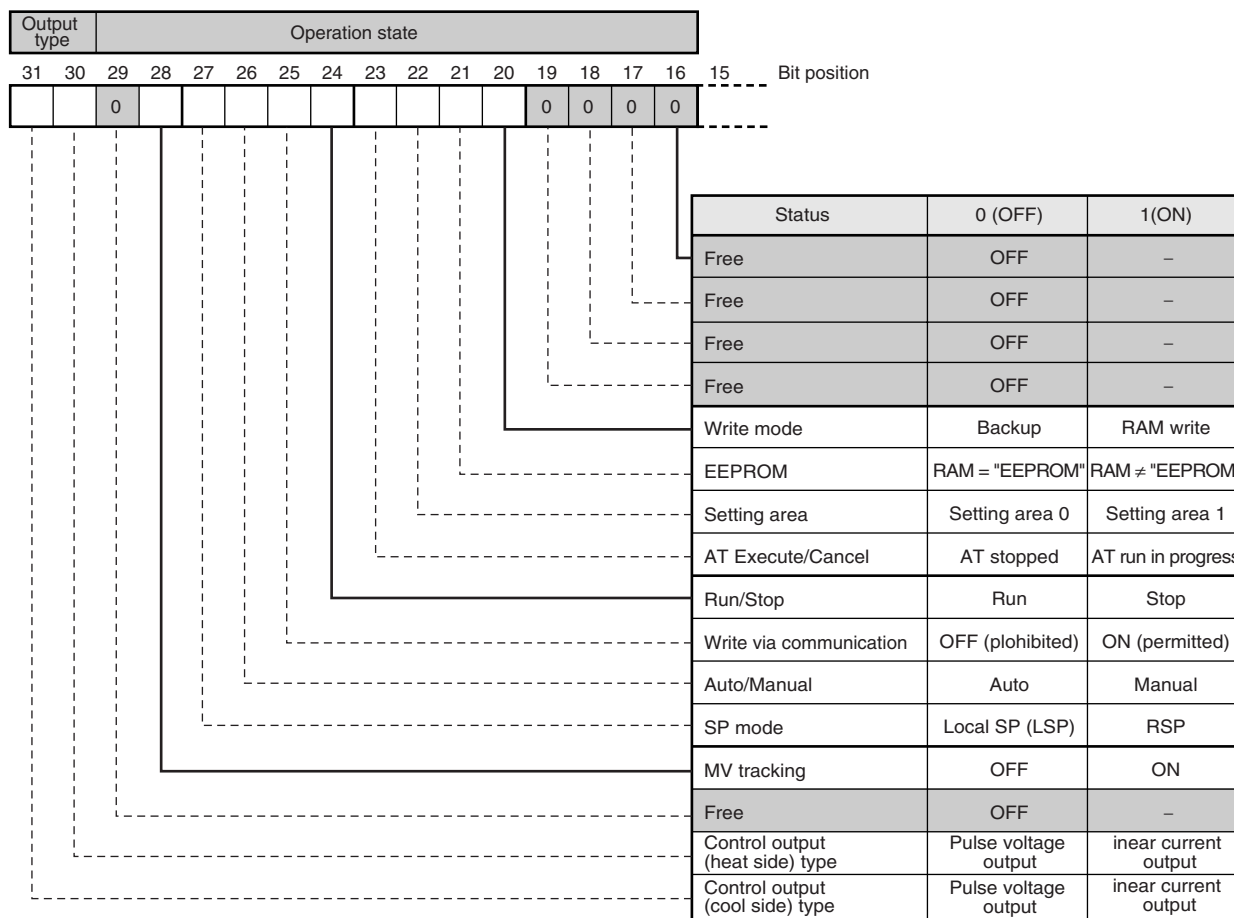

\* As follows when read in setting area 1:

- RSP input error : Clear
- Potentiometer error : Clear
- Display range exceeded : Clear
- Input error : Clear
- Control output (heating), control output (cooling) : Clear
- Alarm 1, Alarm 2, Alarm 3, Alarm 4 : Clear
- AT : Clear
- Run/Stop : ON (stop)
- Auto/Manual : Hold previous value
- SP mode, MV tracking : Update
- Control output (heating), control output (cooling) : Update

\* Control output (heating) and control output (cooling) are respectively open output and close output during position proportional control.

\* Control output (heating) and control output (cooling) are normally OFF during linear output.

\* The control output heating type and/or control output cooling type is off when the corresponding output is pulse voltage output.

## Communication monitor (C4)

"H" "-" indicated in set values (monitor values) are values set by communication (monitor).

| Variable type | CompoWay/F Address | Modbus Address | Setting data        | Attributes | Character                  | Setting (monitor) value            | Character | Default value | Decimal point position  | Units |
|---------------|--------------------|----------------|---------------------|------------|----------------------------|------------------------------------|-----------|---------------|-------------------------|-------|
| C4            | 0000               | 0400           | Version             | Common     | -                          | 000 to FFF *1                      | -         | -             | -                       | -     |
|               | 0001               | 0402           | Modified type       | Common     | -                          | 000 to FFF                         | -         | -             | -                       | -     |
|               | 0002               | 0404           | Present Value(PV)   | CH         | -                          | According to specified input range | -         | -             | According to input type | EU    |
|               | 0003               | 0406           | SP                  | CH         | -                          | *2                                 | -         | -             | According to input type | EU    |
|               | 0004               | 0408           | Bank No. monitor    | CH         | -                          | H'00000000 to H'00000007 (0 to 7)  | 0 to 7    | -             | -                       | -     |
|               | 0005               | 040A           | PID set No. monitor | CH         | -                          | H'00000001 to H'00000008 (1 to 8)  | 1 to 8    | -             | -                       | -     |
| 0006          | 040C               | Status         | CH                  | -          | Refer to previous section. | -                                  | -         | -             | -                       |       |

\*1 .... 00000123 for Ver. 1.23

\*2 .... In Local SP mode: SP setting lower limit to SP setting upper limit

In remote SP mode: Remote SP lower limit to remote SP upper limit (Note that SP limits are in effect)  
During PV tracking: Determined by input type and decimal point position settings.

## Protect level

"H" "-" indicated in set values (monitor values) are values set by communication (monitor).

| Variable type | CompoWay/F Address | Modbus Address | Setting data                 | Attributes | Character | Setting (monitor) value                   | Character | Default value | Decimal point position | Units | Set value |
|---------------|--------------------|----------------|------------------------------|------------|-----------|---|-----------|---------------|------------------------|-------|-----------|
| C5            | 0000               | 0500           | Operation Adjustment Protect | Common     | 0PPE      | H'00000000 to H'00000004 (0 to 4)         | 0 to 4    | 0             | -                      | -     | -         |
|               | 0001               | 0502           | Initial setting protect      | Common     | 1PPE      | H'00000000 to H'00000002 (0 to 2)         | 0 to 2    | 0             | -                      | -     | -         |
|               | 0002               | 0504           | Setting change protect       | Common     | 2PPE      | H'00000000: OFF (0)<br>H'00000001: ON (1) | 0FF, 0n   | OFF           | -                      | -     | -         |
|               | 0003               | 0506           | PF key protect               | Common     | PFPE      | H'00000000: OFF (0)<br>H'00000001: ON (1) | 0FF, 0n   | OFF           | -                      | -     | -         |

Operation level

"H" : indicated in set values (monitor values) are values set by communication (monitor).

| CompoWay/F<br>Variable type | Modbus<br>Address | Setting data          | Attributes | Character | Setting (monitor) value  | Character  | Default<br>value | Decimal point<br>position | Units | Set value |
|-----------------------------|-------------------|-----------------------|------------|-----------|--|--|------------------|---------------------------|-------|-----------|
| C6                          | -                 | PV                    | CH         | -         | Specified range of sensor input  | -  | -                | *1                        | EU    |           |
|                             | 0000              | Manual MV *2          | CH         | -         | Standard: H'00000000 to H'0000041A (-5.0 to 105.0)<br>Heat/cool: H'FFFFFFBE6 to H'0000041A (-105.0 to 105.0)<br>Position proportional: H'FFFFFF9C to H'0000044C (-10.0 to 110.0) | -5.0 to 105.0<br>-105.0 to 105.0<br>-10.0 to 110.0 | -                | 1                         | %     |           |
|                             | 0001              | SP *3                 | CH         | -         | SP setting lower limit to SP setting upper limit   | Same as at left                                    | 0                | According to input type   | EU    |           |
|                             | 0002              | Remote SP monitor     | CH         | r SP      | Remote SP lower limit to remote SP upper limit   | Same as at left                                    | -                | According to input type   | EU    |           |
|                             | 0003              | Ramp SP monitor       | CH         | SP-n      | SP setting lower limit to SP setting upper limit *4  | Same as at left                                    | -                | According to input type   | EU    |           |
|                             | 0005              | MV monitor (heat)     | CH         | a         | H'00000000 to H'0000041A (0.0 to 105.0)  | -5.0 to 105.0<br>0.0 to 105.0                      | -                | 1                         | %     |           |
|                             | 0006              | MV monitor (cool)     | CH         | f -a      | H'00000000 to H'0000041A (0.0 to 105.0)  | 0.0 to 105.0                                       | -                | 1                         | %     |           |
|                             | 0007              | Valve opening monitor | CH         | u-n       | H'FFFFFF9C to H'0000044C (-10.0 to 110.0)  | -10.0 to 110.0                                     | -                | 1                         | %     |           |
|                             | -                 | Run/Stop              | CH         | r-5       | RUN (0)<br>STOP (1)  | run, stop  | RUN              | -                         | %     |           |
|                             | -                 | Auto/Manual           | CH         | R-n       | AUTO (0)<br>MANU (1)   | Auto, Manual                                       | AUTO             | -                         | -     |           |

\*1 ... Determined by input type and "Display below PV decimal point" settings.

\*2 ... In position proportional control, change is only possible from HMI.

\*3 ... Present Value (PV) /SP" has the following 3 displays, and the HMI display is enabled using "Present Value (PV) /SP" display screen selection.

Display 1: Present Value (PV) / SP/Bank No.

Display 2: Present Value (PV) /SP/MV (valve opening during position proportional control)

Display 3: Present Value (PV) /SP/Bank No.

The setting (monitor) values for each are as follows:

PV: Specified range of sensor input

SP

In Local SP mode

In remote SP mode

During Present Value (PV) tracking

MV

Standard / heat/cool

Position proportional

Bank No.: 0 to 7

\*4 ... Note that SP limits are in effect

: SP setting lower limit to SP setting upper limit

: Remote SP lower limit to remote SP upper limit (Note that SP limits are in effect)

: Determined by input type and decimal point position settings.

: -5.0 to 105.0

: -10.0 to 110.0

## Adjustment level

"H-" indicated in set values (monitor values) are values set by communication (monitor).

| CompoWay/F Variable type | Modbus Address | Setting data                               | Attributes | Character | Setting (monitor) value  | Character                        | Default value  | Decimal point position  | Units   | Set value |
|--------------------------|----------------|--|------------|-----------|--|----------------------------------|----------------|-------------------------|---------|-----------|
| C7                       |                |  |            |           |  |                                  |                |                         |         |           |
|                          |                | Bank No.                                   | CH         | ბრპ       | (0 to 7)   | 0 to 7                           | 0              | -                       | -       |           |
|                          |                | AT Execute/Cancel                          | CH         | რე        | OFF (-1)<br>(0 to 8)   | OFF, 0 to 8                      | OFF            | -                       | -       |           |
|                          |                | Write via communication                    | Common     | წაწ       | OFF (0)<br>ON (0)  | OFF, ON                          | OFF            | -                       | -       |           |
|                          |                | SP mode (Remote/Local)*1                   | CH         | სპრ       | Local SP (LSP)(0)<br>RSP (1)   | LSP, RSP                         | Local SP (LSP) | -                       | -       |           |
| 0000                     | 0700           | Cooling coefficient                        | CH         | წ-წ       | H'00000001 to H'0000270F (0.01 to 99.99)   | 0.01 to 99.99                    | 1.00           | 2                       | -       |           |
| 0004                     | 0708           | Dead band                                  | CH         | წ-დბ      | H'FFFFFF831 to H'0000270F (-19.99 to 99.99)  | -19.99 to 99.99                  | 0.00           | 2                       | %FS     |           |
| 0005                     | 070A           | Manual reset value                         | CH         | წ-რ       | H'00000000 to H'000003E8 (0.0 to 100.0)  | 0.0 to 100.0                     | 50.0           | 1                       | %       |           |
| 0006                     | 070C           | Hysteresis (heat)                          | CH         | წ-რ       | H'00000001 to H'0000270F (0.01 to 99.99)   | 0.01 to 99.99                    | 0.10           | 2                       | %FS     |           |
| 0007                     | 070E           | Hysteresis (cool)                          | CH         | წ-რ       | H'00000001 to H'0000270F (0.01 to 99.99)   | 0.01 to 99.99                    | 0.10           | 2                       | %FS     |           |
| 0008                     | 0710           | Control period (heat)                      | CH         | წ-პ       | H'00000002 to H'000003DE (0.2 to 99.0)   | 0.2 to 99.0                      | 20.0           | 1                       | Seconds |           |
| 0009                     | 0712           | Control period (cool)                      | CH         | წ-პ       | H'00000002 to H'000003DE (0.2 to 99.0)   | 0.2 to 99.0                      | 20.0           | 1                       | Seconds |           |
| 000A                     | 0714           | Position proportional dead band            | CH         | დბ        | H'00000001 to H'00000064 (0.1 to 10.0)   | 0.1 to 10.0                      | 2.0            | 1                       | %       |           |
| 000B                     | 0716           | Open/Close hysteresis                      | CH         | წ-წ       | H'00000000 to H'000000C8 (0.1 to 20.0)   | 0.1 to 20.0                      | 0.8            | 1                       | %       |           |
| 000C                     | 0718           | SP ramp time unit                          | CH         | სპრ       | H'00000000: EU/sec: S (0)<br>H'00000001: EU/min: M (1)<br>H'00000002: EU/hour: H (2)   | 5, M, H                          | M              | -                       | -       |           |
| 000D                     | 071A           | SP ramp rise value                         | CH         | სპრ       | H'00000000 to H'0001869F<br>(0 to 9999 (0: Disabled SP ramp function) )  | 0 to 9999                        | 0              | According to input type | EU      |           |
| 000E                     | 071C           | SP ramp fall value                         | CH         | სპრ       | H'00000000 to H'0001869F<br>(0 to 9999 (0: Disabled SP ramp function) )  | 0 to 9999                        | 0              | According to input type | EU      |           |
| 000F                     | 071E           | MV at stop<br>(standard / heat / cool)     | CH         | წ-ს       | Standard: H'FFFFFFCE to H'0000041A (-5.0 to 105.0)<br>Heat / cool: H'FFFFFFBE6 to H'0000041A (-105.0 to 105.0)                                   | -5.0 to 105.0<br>-105.0 to 105.0 | 0.0            | 1                       | %       |           |
| 0010                     | 0720           | MV at stop<br>(position proportional)      | CH         | წ-ს       | H'FFFFFFF:-1 (completely open)<br>H'00000000: 0 (hold)   | -1, 0, 1                         | 0              | -                       | -       |           |
| 0011                     | 0722           | MV at PV error<br>(standard / heat / cool) | CH         | წ-ე       | H'00000001:1 (completely open)<br>Standard: H'FFFFFFCE to H'0000041A (-5.0 to 105.0)<br>Heat / cool: H'FFFFFFBE6 to H'0000041A (-105.0 to 105.0) | -5.0 to 105.0<br>-105.0 to 105.0 | 0.0            | 1                       | %       |           |
| 0012                     | 0724           | MV at PV error<br>(position proportional)  | CH         | წ-ე       | H'FFFFFFF:-1 (completely open)<br>H'00000000: 0 (hold)   | -1, 0, 1                         | 0              | -                       | -       |           |
| 0013                     | 0726           | MV change rate limit (heat)                | CH         | წ-რ       | H'00000000 to H'000003E8<br>(0.0 to 100.0 (0.0: Limiter disabled) )  | 0.0 to 100.0                     | 0.0            | 1                       | %/S     |           |
| 0014                     | 0728           | MV change rate limit (cool)                | CH         | წ-რ       | H'00000000 to H'000003E8<br>(0.0 to 100.0 (0.0: Limiter disabled) )  | 0.0 to 100.0                     | 0.0            | 1                       | %/S     |           |

| CompoWay/F Variable type | Modbus Address | Setting data                       | Attributes | Character | Setting (monitor) value                      | Character          | Default value | Decimal point position  | Units | Set value |
|--------------------------|----------------|------------------------------------|------------|-----------|--|--------------------|---------------|-------------------------|-------|-----------|
| C7                       | 0015           | Input value 1 for input correction | CH         | LS.L.I    | H'FFFFB1E1 to H'0001869F (-19999 to 99999)   | - 19999 to 99999   | -200.0        | According to input type | EU    |           |
|                          | 0016           | Input correction 1                 | CH         | LS.S.I    | H'FFFFB1E1 to H'0001869F (-199.99 to 999.99) | - 199.99 to 999.99 | 0.00          | 2                       | EU    |           |
|                          | 0017           | Input value 2 for input correction | CH         | LS.L.I    | H'FFFFB1E1 to H'0001869F (-19999 to 99999)   | - 19999 to 99999   | 1300.0        | According to input type | EU    |           |
|                          | 0018           | Input correction 2                 | CH         | LS.S.I    | H'FFFFB1E1 to H'0001869F (-199.99 to 999.99) | - 199.99 to 999.99 | 0.00          | 2                       | EU    |           |
|                          | 001F           | Disturbance gain                   | CH         | daLn      | H'FFFFF9C to H'00000064 (-1.00 to 1.00)      | - 1.00 to 1.00     | 0.65          | 2                       | -     |           |
|                          | 0020           | Disturbance time constant          | CH         | daLc      | H'00000001 to H'00000270F (0.01 to 99.99)    | 0.01 to 99.99      | 1.00          | 2                       | -     |           |
|                          | 0021           | Disturbance rectification band     | CH         | da-b      | H'00000000 to H'00000270F (0.000 to 9.999)   | 0.000 to 9.999     | 0.000         | 3                       | %FS   |           |
|                          | 0022           | Disturbance judgement width        | CH         | daLw      | H'FFFFD8F1 to H'00000270F (-99.99 to 99.99)  | - 99.99 to 99.99   | 0.00          | 2                       | %FS   |           |

\*1 .... In Cascade control

Remote SP mode = Cascade closed

Local SP mode = Cascade open

\*2 .... When the input type, temperature unit, or scaling display value is changed, settings are initialized as follows:

Temperature input: Set upper and lower limits of sensor input

Analog input: Scaling display value 1 (lower-limit), 2 (upper-limit)

### Adjustment level 2

| CompoWay/F Variable type | Modbus Address | Setting data                               | Attributes | Character | Setting (monitor) value  | Character          | Default value | Decimal point position | Units   | Set value |
|--------------------------|----------------|--|------------|-----------|--|--------------------|---------------|------------------------|---------|-----------|
| C8                       | 0000           | First order lag operation 1: Time constant | Common     | LR.P.1    | H'00000000 to H'0000270F (0.0 to 999.9)  | 0.0 to 999.9       | 0.0           | 1                      | Seconds |           |
|                          | 0001           | First order lag operation 2: Time constant | Common     | LR.P.2    | H'00000000 to H'0000270F (0.0 to 999.9)  | 0.0 to 999.9       | 0.0           | 1                      | Seconds |           |
|                          | 0002           | First order lag operation 3: Time constant | Common     | LR.P.3    | H'00000000 to H'0000270F (0.0 to 999.9)  | 0.0 to 999.9       | 0.0           | 1                      | Seconds |           |
|                          | 0003           | First order lag operation 4: Time constant | Common     | LR.P.4    | H'00000000 to H'0000270F (0.0 to 999.9)  | 0.0 to 999.9       | 0.0           | 1                      | Seconds |           |
|                          | 0004           | Move average 1: Move average count         | Common     | MR.P.1    | H'00000000 to H'00000005 (1/2/4/8/16/32 times)<br>(Setting values using communication are 0/1/2/3/4/5) | 1, 2, 4, 8, 16, 32 | 1             | -                      | times   |           |
|                          | 0005           | Move average 2: Move average count         | Common     | MR.P.2    | H'00000000 to H'00000005 (1/2/4/8/16/32 times)<br>(Setting values using communication are 0/1/2/3/4/5) | 1, 2, 4, 8, 16, 32 | 1             | -                      | times   |           |
|                          | 0006           | Move average 3: Move average count         | Common     | MR.P.3    | H'00000000 to H'00000005 (1/2/4/8/16/32 times)<br>(Setting values using communication are 0/1/2/3/4/5) | 1, 2, 4, 8, 16, 32 | 1             | -                      | times   |           |
|                          | 0007           | Move average 4: Move average count         | Common     | MR.P.4    | H'00000000 to H'00000005 (1/2/4/8/16/32 times)<br>(Setting values using communication are 0/1/2/3/4/5) | 1, 2, 4, 8, 16, 32 | 1             | -                      | times   |           |
|                          | 0008           | Extraction of square root 1 low-cut point  | Common     | SR.P.1    | H'00000000 to H'00000270F (0.0 to 9.999)   | 0.000 to 9.999     | 0.000         | 3                      | - *     |           |
|                          | 0009           | Extraction of square root 2 low-cut point  | Common     | SR.P.2    | H'00000000 to H'00000270F (0.0 to 9.999)   | 0.000 to 9.999     | 0.000         | 3                      | 1       |           |
|                          | 000A           | Extraction of square root 3 low-cut point  | Common     | SR.P.3    | H'00000000 to H'00000270F (0.0 to 9.999)   | 0.000 to 9.999     | 0.000         | 3                      | - *     |           |
|                          | 000B           | Extraction of square root 4 low-cut point  | Common     | SR.P.4    | H'00000000 to H'00000270F (0.0 to 9.999)   | 0.000 to 9.999     | 0.000         | 3                      | 1       |           |
|                          | 000C           | Analog parameter (control proportion)      | Common     | RP.I      | H'FFFFF831 to H'00000270F (-1.999 to 9.999)  | - 1.999 to 9.999   | 1.000         | 3                      | - *     |           |

\*1 .... These are set values for each of the operation functions. Set normalized values based on the input data for the operation function.

When a straight-line approximation is included in the input stage of input type K -200.0 to 1300.0°C, -200.0 to 1300.0°C is equivalent to the normalized value 0.000 to 1.000.

Bank setting level

| CompoWay/F Variable type | Modbus Address | Setting data               | Attributes | Character       | Setting (monitor) value                               | Character                      | Default value | Decimal point position  | Units | Set value |
|--------------------------|----------------|----------------------------|------------|-----------------|---|--------------------------------|---------------|-------------------------|-------|-----------|
| C9                       | -              | Display bank selection     | CH         | <b>d.b.n.p</b>  | 0 to 7  | <b>0</b> to <b>7</b>           | *1            | -                       | -     |           |
| 0000                     | 0900           | Bank 0 local SP (LSP)      | CH         | <b>0.L.SP</b>   | SP setting lower limit to SP setting upper limit      | Same as at left                | 0             | According to input type | EU    |           |
| 0001                     | 0902           | Bank 0 PID set number      | CH         | <b>0.P.L.d</b>  | H'00000000 to H'00000008 (0 to 8 (0: Auto selection)) | <b>0</b> to <b>8</b>           | 0             | -                       | -     |           |
| 0002                     | 0904           | Bank 0 alarm value 1       | CH         | <b>0.AL - 1</b> | H'FFFFB1E1 to H'0001869F (-19999 to 99999)            | - <b>19999</b> to <b>99999</b> | 0             | According to input type | EU    |           |
| 0003                     | 0906           | Bank 0 alarm upper limit 1 | CH         | <b>0.AL.UH</b>  | H'FFFFB1E1 to H'0001869F (-19999 to 99999)            | - <b>19999</b> to <b>99999</b> | 0             | According to input type | EU    |           |
| 0004                     | 0908           | Bank 0 alarm lower limit 1 | CH         | <b>0.AL.LL</b>  | H'FFFFB1E1 to H'0001869F (-19999 to 99999)            | - <b>19999</b> to <b>99999</b> | 0             | According to input type | EU    |           |
| 0005                     | 090A           | Bank 0 alarm value 2       | CH         | <b>0.AL - 2</b> | H'FFFFB1E1 to H'0001869F (-19999 to 99999)            | - <b>19999</b> to <b>99999</b> | 0             | According to input type | EU    |           |
| 0006                     | 090C           | Bank 0 alarm upper limit 2 | CH         | <b>0.AL.UH</b>  | H'FFFFB1E1 to H'0001869F (-19999 to 99999)            | - <b>19999</b> to <b>99999</b> | 0             | According to input type | EU    |           |
| 0007                     | 090E           | Bank 0 alarm lower limit 2 | CH         | <b>0.AL.LL</b>  | H'FFFFB1E1 to H'0001869F (-19999 to 99999)            | - <b>19999</b> to <b>99999</b> | 0             | According to input type | EU    |           |
| 0008                     | 0910           | Bank 0 alarm value 3       | CH         | <b>0.AL - 3</b> | H'FFFFB1E1 to H'0001869F (-19999 to 99999)            | - <b>19999</b> to <b>99999</b> | 0             | According to input type | EU    |           |
| 0009                     | 0912           | Bank 0 alarm upper limit 3 | CH         | <b>0.AL.UH</b>  | H'FFFFB1E1 to H'0001869F (-19999 to 99999)            | - <b>19999</b> to <b>99999</b> | 0             | According to input type | EU    |           |
| 000A                     | 0914           | Bank 0 alarm lower limit 3 | CH         | <b>0.AL.LL</b>  | H'FFFFB1E1 to H'0001869F (-19999 to 99999)            | - <b>19999</b> to <b>99999</b> | 0             | According to input type | EU    |           |
| 000B                     | 0916           | Bank 0 alarm value 4       | CH         | <b>0.AL - 4</b> | H'FFFFB1E1 to H'0001869F (-19999 to 99999)            | - <b>19999</b> to <b>99999</b> | 0             | According to input type | EU    |           |
| 000C                     | 0918           | Bank 0 alarm upper limit 4 | CH         | <b>0.AL.UH</b>  | H'FFFFB1E1 to H'0001869F (-19999 to 99999)            | - <b>19999</b> to <b>99999</b> | 0             | According to input type | EU    |           |
| 000D                     | 091A           | Bank 0 alarm lower limit 4 | CH         | <b>0.AL.LL</b>  | H'FFFFB1E1 to H'0001869F (-19999 to 99999)            | - <b>19999</b> to <b>99999</b> | 0             | According to input type | EU    |           |
| 000E                     | 091C           | Bank 1 local SP (LSP)      | CH         | <b>1.L.SP</b>   | The following is the same as Bank 0                   |                                | 0             | According to input type | EU    |           |
| 001C                     | 0938           | Bank 2 local SP (LSP)      | CH         | <b>2.L.SP</b>   |   |                                |               |                         |       |           |
| 002A                     | 0954           | Bank 3 local SP (LSP)      | CH         | <b>3.L.SP</b>   |   |                                |               |                         |       |           |
| 0038                     | 0970           | Bank 4 local SP (LSP)      | CH         | <b>4.L.SP</b>   |   |                                |               |                         |       |           |
| 0046                     | 098C           | Bank 5 local SP (LSP)      | CH         | <b>5.L.SP</b>   |   |                                |               |                         |       |           |
| 0054                     | 09A8           | Bank 6 local SP (LSP)      | CH         | <b>6.L.SP</b>   |   |                                |               |                         |       |           |
| 0062                     | 09C4           | Bank 7 local SP (LSP)      | CH         | <b>7.L.SP</b>   |   |                                |               |                         |       |           |
| 006F                     | 09DE           | Bank 7 alarm lower limit 4 | CH         | <b>7.AL.LL</b>  |   |                                |               |                         |       |           |

\*1 .... Bank number selected for execution.

"H" - indicated in set values (monitor values) are values set by communication (monitor).

| Variable type | CompoWay/F Address | Modbus Address | Setting data                                     | Attributes | Character        | Setting (monitor) value   | Character  | Default value | Decimal point position  | Units   | Set value |
|---------------|--------------------|----------------|--|------------|------------------|---|--|---------------|-------------------------|---------|-----------|
|               |                    |                |  |            |                  |   |  |               |                         |         |           |
| CA            | 0000               | 0A00           | Display PID selection                            | CH         | <b>dP.Ld</b>     | H'00000001 to H'00000008 (1 to 8)   | <b>1</b> to <b>8</b>                                       | *5            | -                       | -       |           |
|               | 0001               | 0A02           | PID 1 proportional band                          | CH         | <b>iP</b>        | Standard / Heat / cool: H'00000000 to H'0001869F (0.00 to 999.99)<br>Position proportional: H'00000001 to H'0001869F (0.01 to 999.99)   | <b>0.00</b> to <b>99999</b><br><b>0.01</b> to <b>99999</b> | 10.00         | 2                       | %FS     |           |
|               | 0002               | 0A04           | PID 1 integral time                              | CH         | <b>iL</b>        | Standard / Heat / cool / Position proportional (closed, operation stops at potentiometer input error):<br>H'00000000 to H'00009C3F (0.0 to 3999.9)  | <b>0.0</b> to <b>39999</b>                                 | 233.0         | 1                       | Seconds |           |
|               | 0003               | 0A06           | PID 1 derivative time                            | CH         | <b>i.d</b>       | Standard / Heat / cool / Position proportional (closed, operation stops at potentiometer input error):<br>H'00000000 to H'00009C3F (0.0 to 3999.9)  | <b>0.0</b> to <b>39999</b>                                 | 40.0          | 1                       | Seconds |           |
|               | 0004               | 0A08           | PID 1 integral time *1                           | CH         | -                | Standard / Heat / cool / Position proportional (closed, operation stops at potentiometer input error):<br>H'00000000 to H'00061A76 (0.00 to 3999.90)  | -  | 233.00        | 2                       | Seconds |           |
|               | 0005               | 0A0A           | PID 1 MV upper limit                             | CH         | <b>i.d.L - H</b> | Standard / Heat / cool / Position proportional (closed, operation continues or floats at potentiometer input error):<br>H'00000000 to H'00061A76 (0.10 to 3999.90)  | -  | 40.00         | 2                       | Seconds |           |
|               | 0006               | 0A0C           | PID 1 MV lower limit                             | CH         | <b>i.d.L - L</b> | Standard: MV lower limit +0.1 to H'0000041A (105.0)<br>Heat/cool: H'00000000 to H'0000041A (0.0 to 105.0)<br>Standard: H'FFFFFFE (-5.0) to MV upper limit -0.1<br>Heat / cool: H'0000041A to H'00000000 (-105.0 to 0.0) | Same as at left  | 100.0         | 1                       | %       |           |
|               | 0007               | 0A0E           | PID 1 automatic selection range upper limit (PV) | CH         | <b>i.R.LL</b>    | H'FFFFFFE1 to H'0001869F (-19999 to 99999)  | - <b>99999</b> to <b>99999</b>                             | 1450.0        | According to input type | EU      |           |
|               | 0008               | 0A10           | PID 1 automatic selection range upper limit (DV) | CH         | <b>i.R.LL</b>    | H'FFFFFFE1 to H'0001869F (-19999 to 99999)  | - <b>99999</b> to <b>99999</b>                             | 1650.0        | According to input type | EU      |           |
|               | 0009               | 0A12           | PID 2 proportional band                          | CH         | <b>2.P</b>       | The following is the same as PID1   |  | *3            |                         |         |           |
|               | 0012               | 0A24           | PID 3 proportional band                          | CH         | <b>3.P</b>       |   |  |               |                         |         |           |
|               | 001B               | 0A36           | PID 4 proportional band                          | CH         | <b>4.P</b>       |   |  |               |                         |         |           |
|               | 0024               | 0A48           | PID 5 proportional band                          | CH         | <b>5.P</b>       |   |  |               |                         |         |           |
|               | 002D               | 0A5A           | PID 6 proportional band                          | CH         | <b>6.P</b>       |   |  |               |                         |         |           |



| Variable type | CompoWay/F Address | Modbus Address                                   | Setting data                                     | Attributes   | Character   | Setting (monitor) value                          | Character | Default value           | Decimal point position  | Units | Set value |
|---------------|--------------------|--|--|--------------|---|--|-----------|-------------------------|-------------------------|-------|-----------|
| CA            | 0036               | 0A6C   | PID 7 proportional band                          | CH           | <b>7.P</b>  |  |           |                         |                         |       |           |
|               |                    |  | ~  | CH           |   |  |           |                         |                         |       |           |
|               | 003F               | 0A7E   | PID 8 proportional band                          | CH           | <b>8.P</b>  |  |           |                         |                         |       |           |
|               |                    |  | ~  | CH           |   |  |           |                         |                         |       |           |
|               | 0046               | 0A8C   | PID 8 automatic selection range upper limit (PV) | CH           | <b>8.PUL</b>  | Same as display range of "Present value (PV)" *2 |           | 1450.0                  | According to input type | EU    |           |
| 0047          | 0A8E               | PID 8 automatic selection range upper limit (DV) | CH   | <b>8.DUL</b> | Temperature input: Specified range of sensor input<br>Analog input: -110% to 110% of scaling range<br>However, maximum is H'FFFFB1E1 to H'0001869F (-19999 to 99999) *4 |  | 1650.0    | According to input type | EU                      |       |           |

- \*1 .... Not displayed in HMI.
- \*2 .... Specified upper limit of input  
The maximum is -19999 to 99999.
- \*3 .... Temperature input: Specified range width of sensor input  
Analog input: -110% to 110% of scaling range width  
The maximum is -19999 to 99999.
- \*4 .... The upper limit of the automatic selection range of PID set No. 8 is fixed at 999.99% FS for internal data (this can be changed but it will not affect operation).
- \*5 .... Selected PID set number.

Approximation setting level

| Variable type | CompoWay/F Address | Modbus Address                        | Setting data                           | Attributes       | Character                                  | Setting (monitor) value                    | Character        | Default value | Decimal point position | Units | Set value |
|---------------|--------------------|---------------------------------------|--|------------------|--|--|------------------|---------------|------------------------|-------|-----------|
| CB            | 0000               | 0B00                                  | Straight-line approximation 1 input 1  | Common           | <b>5.1.1</b>                               | H'FFFFF831 to H'0000270F (-1.999 to 9.999) | - 1.999 to 9.999 | 0.000         | 3                      | -*1   |           |
|               | 0001               | 0B02                                  | Straight-line approximation 1 input 2  | Common           | <b>5.1.2</b>                               | H'FFFFF831 to H'0000270F (-1.999 to 9.999) | - 1.999 to 9.999 | 1.000         | 3                      | -*1   |           |
|               | 0002               | 0B04                                  | Straight-line approximation 1 output 1 | Common           | <b>5.2.1</b>                               | H'FFFFF831 to H'0000270F (-1.999 to 9.999) | - 1.999 to 9.999 | 0.000         | 3                      | -*1   |           |
|               | 0003               | 0B06                                  | Straight-line approximation 1 output 2 | Common           | <b>5.2.1</b>                               | H'FFFFF831 to H'0000270F (-1.999 to 9.999) | - 1.999 to 9.999 | 1.000         | 3                      | -*1   |           |
|               | 0004               | 0B08                                  | Straight-line approximation 2 input 1  | Common           | <b>5.1.2</b>                               | H'FFFFF831 to H'0000270F (-1.999 to 9.999) | - 1.999 to 9.999 | 0.000         | 3                      | -*1   |           |
|               | 0005               | 0B0A                                  | Straight-line approximation 2 input 2  | Common           | <b>5.2.2</b>                               | H'FFFFF831 to H'0000270F (-1.999 to 9.999) | - 1.999 to 9.999 | 1.000         | 3                      | -*1   |           |
|               | 0006               | 0B0C                                  | Straight-line approximation 2 output 1 | Common           | <b>5.2.1</b>                               | H'FFFFF831 to H'0000270F (-1.999 to 9.999) | - 1.999 to 9.999 | 0.000         | 3                      | -*1   |           |
|               | 0007               | 0B0E                                  | Straight-line approximation 2 output 2 | Common           | <b>5.2.2</b>                               | H'FFFFF831 to H'0000270F (-1.999 to 9.999) | - 1.999 to 9.999 | 1.000         | 3                      | -*1   |           |
|               | 0010               | 0B20                                  | Broken-line approximation 1 input 1    | Common           | <b>F.0.1.1</b>                             | H'FFFFF831 to H'0000270F (-1.999 to 9.999) | - 1.999 to 9.999 | 0.000         | 3                      | -*1   |           |
|               |                    |                                       | ~                                      |                  |  |  |                  |               |                        |       |           |
| 0023          | 0B46               | Broken-line approximation 1 input 20  | Common                                 | <b>F.2.0.1</b>   | H'FFFFF831 to H'0000270F (-1.999 to 9.999) | - 1.999 to 9.999                           | 0.000            | 0.000         | 3                      | -*1   |           |
| 0024          | 0B48               | Broken-line approximation 1 output 1  | Common                                 | <b>F.2.0.1.1</b> | H'FFFFF831 to H'0000270F (-1.999 to 9.999) | - 1.999 to 9.999                           | 0.000            | 0.000         | 3                      | -*1   |           |
|               |                    | ~                                     |  |                  |  |  |                  |               |                        |       |           |
| 0037          | 0B6E               | Broken-line approximation 1 output 20 | Common                                 | <b>F.2.0.1</b>   | H'FFFFF831 to H'0000270F (-1.999 to 9.999) | - 1.999 to 9.999                           | 0.000            | 0.000         | 3                      | -*1   |           |

- \*1 .... These are set values for each of the operation functions. Set normalized values based on the input data for the operation function.  
When a straight-line approximation is included in the input stage of input type K -200.0 to 1300.0°C, -200.0 to 1300.0°C is equivalent to the normalized value 0.000 to 1.000.

Input initial setting level

"H-" indicated in set values (monitor values) are values set by communication (monitor).

| CompoWay/F Variable type | Modbus Address | Setting data                            | Attributes | Character | Setting (monitor) value  | Character       | Default value | Decimal point position  | Units | Set value |
|--------------------------|----------------|---|------------|-----------|--|-----------------|---------------|-------------------------|-------|-----------|
| CC                       | 0000           | Input 1 type                            | Common     | 1-1-1     | H'00000000:P1100 (0)<br>H'00000001:P1100 (1)<br>H'00000002:K (2)<br>H'00000003:K (3)<br>H'00000004:J (4)<br>H'00000005:J (5)<br>H'00000006:T (6)<br>H'00000007:E (7)<br>H'00000008:L (8)<br>H'00000009:U (9)<br>H'0000000A:N (10)<br>H'0000000B:R (11)<br>H'0000000C:S (12)<br>H'0000000D:B (13)<br>H'0000000E:W (14)<br>H'0000000F:4 to 20 mA (15)<br>H'00000010:0 to 20 mA (16)<br>H'00000011:1 to 5 V (17)<br>H'00000012:0 to 5 V (18)<br>H'00000013:0 to 10 V (19) | 0 to 19         | 2 *4          | -                       | -     | -         |
| 0001                     | 0C02           | Input 1 temperature units               | Common     | 1-1d1     | H'00000000:°C (0)<br>H'00000001:F (1)  | 1, F            | °C            | -                       | -     | -         |
| 0002                     | 0C04           | Input 2 type                            | Common     | 2-2-1     | Input 1: Same as input type  | 0 to 19         | 2 *4          | -                       | -     | -         |
| 0003                     | 0C06           | Input 2 temperature units               | Common     | 2-2d1     | H'00000000:°C (0)<br>H'00000001:F (1)  | 1, F            | °C            | -                       | -     | -         |
| 0004                     | 0C08           | Input 3 type                            | Common     | 3-3-1     | Input 1: Same as input type  | 0 to 19         | 2 *4          | -                       | -     | -         |
| 0005                     | 0C0A           | Input 3 temperature units               | Common     | 3-3d1     | H'00000000:°C (0)<br>H'00000001:F (1)  | 1, F            | °C            | -                       | -     | -         |
| 0006                     | 0C0C           | Input 4 type                            | Common     | 4-4-1     | Input 1: Same as input type  | 0 to 19         | 2 *4          | -                       | -     | -         |
| 0007                     | 0C0E           | Input 4 temperature units               | Common     | 4-4d1     | H'00000000:°C (0)<br>H'00000001:F (1)  | 1, F            | °C            | -                       | -     | -         |
| 0008                     | 0C10           | Scaling input value 1                   | CH         | 1-1P-1    | Input lower-limit to input upper-limit   | Same as at left | 4 *3          | 0                       | *2    | -         |
| 0009                     | 0C12           | Scaling display value 1                 | CH         | 1-1SP-1   | H'FFFFF1E1 (-19999) to scaling display value 2-1   | Same as at left | 0             | -                       | EU    | -         |
| 000A                     | 0C14           | Scaling input value 2                   | CH         | 1-1P-2    | Input lower-limit to input upper-limit   | Same as at left | 20 *3         | 0                       | *2    | -         |
| 000B                     | 0C16           | Scaling display value 2                 | CH         | 1-1SP-2   | Scaling display value 1+1 to H'0000270F (99999)  | Same as at left | 100           | -                       | EU    | -         |
| 000C                     | 0C18           | Decimal point position                  | CH         | 1-1dP     | H'00000000 to H'00000004 (0 to 4)  | 0 to 4          | 0             | -                       | -     | -         |
| 000D                     | 0C1A           | Remote SP upper limit                   | CH         | 1-1SPH    | Temperature:<br>Lower limit of sensor setting range to upper limit of sensor setting range<br>Analog:<br>Larger of +19999 and "display value equivalent to input lower limit" to smaller of 99999 and "display value equivalent to input upper limit"  | Same as at left | 1300          | According to input type | EU    | -         |
| 000E                     | 0C1C           | Remote SP lower limit                   | CH         | 1-1SPL    | Temperature:<br>Sensor setting range to upper limit of sensor setting range<br>Analog:<br>Larger of -19999 and "display value equivalent to input lower limit" to smaller of 99999 and "display value equivalent to input upper limit"   | Same as at left | -200          | According to input type | EU    | -         |
| 000F                     | 0C1E           | PV decimal point display                | CH         | 1-1dP     | H'00000000: OFF (0)  | OFF, ON         | ON            | -                       | -     | -         |
| 0010                     | 0C20           | Sensor induction noise reduction        | Common     | 5nL       | H'00000000:50 Hz (0)<br>H'00000001:60 Hz (1)   | 50Hz, 60Hz      | 50 Hz         | -                       | -     | -         |
| -                        | -              | Move to advanced function setting level | Common     | 1-1d1d1   | H'FFFFFF831 to H'0000270F (-19999 to 99999)  | -19999 to 99999 | 0             | -                       | -     | -         |

\*1 .... Input type settings are 0 to 14 for temperature input and 15 to 19 for analog input as determined by the input type switch (under the unit).

\*2 .... Determined by input type setting.

\*3 .... Initializes to upper and lower limits of input when the input type is changed.

\*4 .... The default value for the input type is "2" regardless of the setting of the input type switch.

## Control initial setting level

\*H<sup>-</sup> indicated in set values (monitor values) are values set by communication (monitor).

| CompoWay/F<br>Variable type | Modbus<br>Address | Setting data                 | Attributes | Character | Setting (monitor) value   | Character       | Default<br>value  | Decimal point<br>position  | Units | Set value |
|-----------------------------|-------------------|------------------------------|------------|-----------|---|-----------------|-------------------|----------------------------|-------|-----------|
| CD                          | 0000              | Output 1 type                | Common     | ā ī-ē     | H <sup>00000000</sup> : Pulse voltage output (0)<br>H <sup>00000001</sup> : Linear current output (1)   | ā to ī          | 0                 | -                          | -     |           |
|                             | 0001              | Output 3 type                | Common     | ā ā-ē     | H <sup>00000000</sup> : Pulse voltage output (0)<br>H <sup>00000001</sup> : Linear current output (1)   | ā to ī          | 0                 | -                          | -     |           |
|                             | 0003              | Linear current output 1 type | Common     | ē ā ī-ē   | H <sup>00000000</sup> : 0 to 20 mA (0)<br>H <sup>00000001</sup> : 4 to 20 mA (1)  | ē to ī          | 1                 | -                          | -     |           |
|                             | 0004              | Linear current output 2 type | Common     | ē ā ā-ē   | H <sup>00000000</sup> : 0 to 20 mA (0)<br>H <sup>00000001</sup> : 4 to 20 mA (1)  | ē to ī          | 1                 | -                          | -     |           |
|                             | 0005              | Linear current output 3 type | Common     | ē ā ā-ē   | H <sup>00000000</sup> : 0 to 20 mA (0)<br>H <sup>00000001</sup> : 4 to 20 mA (1)  | ē to ī          | 1                 | -                          | -     |           |
|                             | 0006              | Linear current output 4 type | Common     | ē ā ā-ē   | H <sup>00000000</sup> : 0 to 20 mA (0)<br>H <sup>00000001</sup> : 4 to 20 mA (1)  | ē to ī          | 1                 | -                          | -     |           |
|                             | 000F              | SP upper limit               | CH         | ē ī-ē     | SP setting lower limit + 1 to input range upper limit (temperature)<br>SP setting lower limit + 1 to H <sup>0001869F</sup> (lesser of 99999 or display value equivalent of input upper limit) (analog)  | Same as at left | 1300.0<br>*1      | According to<br>input type | EU    |           |
|                             | 0010              | SP lower limit               | CH         | ē ī-ē     | Lower limit of input range to SP lower limit - 1 (temperature)<br>Larger of H <sup>FFFFF1E1</sup> (-19999) and display value equivalent of input lower value to SP upper limit - 1 (analog)   | Same as at left | -200.0<br>*1      | According to<br>input type | EU    |           |
|                             | 0011              | Control mode                 | Common     | ē ā ē     | 1-input type, 4-input type<br>H <sup>00000000</sup> : Standard (0)<br>H <sup>00000001</sup> : Heat/cool (1)<br>2-input type<br>H <sup>00000000</sup> : Standard (0)<br>H <sup>00000001</sup> : Heat/cool (1)<br>H <sup>00000002</sup> : Remote SP standard (2)<br>H <sup>00000003</sup> : Remote SP heating/cooling (3)<br>H <sup>00000004</sup> : Proportional (4)<br>H <sup>00000005</sup> : Cascade standard (5)<br>H <sup>00000006</sup> : Cascade heating or cooling (6) | -               | 0                 | -                          | -     |           |
|                             | 0012              | Forward/reverse operation    | CH         | ē ā ē     | H <sup>00000000</sup> : Reverse action: OR-R (0)<br>H <sup>00000001</sup> : Direct action: OR-D (1)   | ē ā ē, ē ā ē    | Reverse<br>action | -                          | -     |           |
|                             | 0013              | Closed/floating              | CH         | ē ē ē     | H <sup>00000000</sup> : Floating: FLOAT (0)<br>H <sup>00000001</sup> : Close: CLOSE (1)   | ē ē ē, ē ē ē    | Floating          | -                          | -     |           |

\*1 .... When the input type, temperature units, or scaling display value is changed, settings are initialized as follows:

Temperature input: Set upper and lower limits of sensor input

Analog input: Scaling display value 1 (lower limit), 2 (upper limit)

## Control initial setting 2 level

| CompoWay/F<br>Variable type | Modbus<br>Address | Setting data                         | Attributes | Character | Setting (monitor) value  | Character | Default<br>value | Decimal point<br>position | Units | Set value |
|-----------------------------|-------------------|--------------------------------------|------------|-----------|--|-----------|------------------|---------------------------|-------|-----------|
| CE                          | 0006              | Control/Transfer output 1 allocation | Common     | 0000.0    | H'00000000: Disabled (0)<br>H'00000001: CH1 control output (heating side or open side) For control output (1)<br>H'00000002: CH1 control output (heating side or closed side) For control output (2)<br>H'00000003: CH1 SP (3)<br>H'00000004: CH1 ramp SP (4)<br>H'00000005: CH1 Present Value(PV) (5)<br>H'00000006: CH1 control output (heating side or open side) For transfer output (6)<br>H'00000007: CH1 control output (cooling side or closed side) For transfer output (7)<br>H'00000008: CH1 valve opening (8)<br>Similarly,<br>H'00000009 to H'00000010: CH2 (9 to 15)<br>H'00000011 to H'00000018: CH3 (17 to 23)<br>H'00000019 to H'00000020: CH4 (25 to 31) | 00 to 00  | *2<br>(P.A-22)   | -                         | -     | -         |
|                             | 0007              | Control/Transfer output 2 allocation | Common     | 0000.0    | Same as above  | 00 to 00  | Same as above    | -                         | -     | -         |
|                             | 0008              | Control/Transfer output 3 allocation | Common     | 0000.0    | Same as above  | 00 to 00  | Same as above    | -                         | -     | -         |
|                             | 0009              | Control/Transfer output 4 allocation | Common     | 0000.0    | Same as above  | 00 to 00  | Same as above    | -                         | -     | -         |
|                             | 000A              | Event input 1 allocation             | Common     | 0000.0    | H'00000000: Disabled (0)<br>H'00000001: Write via communication OFF/ON (1)<br>H'00000002: CH1 Bank (bit 0) (2)<br>H'00000003: CH1 Bank (bit 1) (3)<br>H'00000004: CH1 Bank (bit 2) (4)<br>H'00000005: CH1 Run/stop (5)<br>H'00000006: CH1 Auto/manual (6)<br>H'00000007: CH1 SP mode (remote/local) (7)<br>Similarly,<br>H'00000008 to H'0000000D: CH2 (8 to 13)<br>H'0000000E to H'00000013: CH3 (14 to 19)<br>H'00000014 to H'00000019: CH4 (20 to 25)   | 00 to 00  | 0                | -                         | -     | -         |
|                             | 000B              | Event input 2 allocation             | Common     | 0000.0    | Same as above  | 00 to 00  | Same as above    | -                         | -     | -         |
|                             | 000C              | Event input 3 allocation             | Common     | 0000.0    | Same as above  | 00 to 00  | Same as above    | -                         | -     | -         |
|                             | 000D              | Event input 4 allocation             | Common     | 0000.0    | Same as above  | 00 to 00  | Same as above    | -                         | -     | -         |
|                             | 000E              | Event input 5 allocation             | Common     | 0000.0    | Same as above  | 00 to 00  | Same as above    | -                         | -     | -         |
|                             | 000F              | Event input 6 allocation             | Common     | 0000.0    | Same as above  | 00 to 00  | Same as above    | -                         | -     | -         |

"H" - indicated in set values (monitor values) are values set by communication (monitor).

| CompoWay/F<br>Variable type | Modbus<br>Address | Setting data                        | Attributes | Character | Setting (monitor) value   | Character       | Default<br>value | Decimal point<br>position | Units           | Set value |
|-----------------------------|-------------------|-------------------------------------|------------|-----------|---|-----------------|------------------|---------------------------|-----------------|-----------|
| CE                          | 0010              | Auxiliary output 1 allocation       | Common     | 5b.1      | H'00000000: Disabled (0)<br>H'00000001: CH1 Alarm 1 (1)<br>H'00000002: CH1 Alarm 2 (2)<br>H'00000003: CH1 Alarm 3 (3)<br>H'00000004: CH1 Alarm 4 (4)<br>H'00000005: CH1 Input error (5)<br>H'00000006: CH1RSP Input error (6)<br>H'00000007: -<br>H'00000008: U-ALM (8)<br>H'00000009: All channels Alarm 1 OR output (9)<br>H'0000000A: All channels Alarm 2 OR output (10)<br>H'0000000B: All channels Alarm 3 OR output (11)<br>H'0000000C: All channels Alarm 4 OR output (12)<br>H'0000000D: All channels input error OR output (13)<br>H'0000000E: All channels RSP input error OR output (14)<br>H'0000000F: - | 5 to 35         | 1                | -                         | -               |           |
|                             | 0011              | Auxiliary output 2 allocation       | Common     | 5b.2      | H'00000010: CH2 Alarm 1 (16)<br>H'00000011: CH2 Alarm 2 (17)<br>H'00000012: CH2 Alarm 3 (18)<br>H'00000013: CH2 Alarm 4 (19)<br>H'00000014: CH2 Input error (20)<br>H'00000015: CH2 RSP input error (21)<br>H'00000016: -   | Same as above   | 2                | -                         | -               |           |
|                             | 0012              | Auxiliary output 3 allocation       | Common     | 5b.3      | Similarly,<br>H'00000017 to H'0000001D: CH3 (23 to 29)<br>H'0000001E to H'0000001F: CH4 (30 to 36)  | Same as above   | 3                | -                         | -               |           |
|                             | 0013              | Auxiliary output 4 allocation       | Common     | 5b.4      |   | Same as above   | 4                | -                         | -               |           |
|                             | 0014              | Transfer output 1 upper-limit       | Common     | r.H.1     |   | Same as at left | Same as at left  | Same as at left           | Same as at left |           |
|                             | 0015              | Transfer output 1 lower-limit       | Common     | r.L.1     |   | Same as at left | Same as at left  | Same as at left           | Same as at left |           |
|                             | 0016              | Transfer output 2 upper-limit       | Common     | r.H.2     |   | Same as at left | Same as at left  | Same as at left           | Same as at left |           |
|                             | 0017              | Transfer output 2 lower-limit       | Common     | r.L.2     |   | Same as at left | Same as at left  | Same as at left           | Same as at left |           |
|                             | 0018              | Transfer output 3 upper-limit       | Common     | r.H.3     |   | Same as at left | Same as at left  | Same as at left           | Same as at left |           |
|                             | 0019              | Transfer output 3 lower-limit       | Common     | r.L.3     |   | Same as at left | Same as at left  | Same as at left           | Same as at left |           |
|                             | 001A              | Transfer output 4 upper-limit       | Common     | r.H.4     |   | Same as at left | Same as at left  | Same as at left           | Same as at left |           |
|                             | 001B              | Transfer output 4 lower-limit       | Common     | r.L.4     |   | Same as at left | Same as at left  | Same as at left           | Same as at left |           |
|                             | 001C              | First order lag operation 1 enabled | Common     | r.L.1     | H'00000000: OFF (0)<br>H'00000001: ON (1)   | OFF, ON         | OFF              | -                         | -               |           |
|                             | 001D              | First order lag operation 2 enabled | Common     | r.L.2     | H'00000000: OFF (0)<br>H'00000001: ON (1)   | OFF, ON         | OFF              | -                         | -               |           |
|                             | 001E              | First order lag operation 3 enabled | Common     | r.L.3     | H'00000000: OFF (0)<br>H'00000001: ON (1)   | OFF, ON         | OFF              | -                         | -               |           |
|                             | 001F              | First order lag operation 4 enabled | Common     | r.L.4     | H'00000000: OFF (0)<br>H'00000001: ON (1)   | OFF, ON         | OFF              | -                         | -               |           |

| Variable type | CompoWay/F Address | Modbus Address | Setting data                          | Attributes | Character                            | Setting (monitor) value                   | Character | Default value | Decimal point position | Units | Set value |   |
|---------------|--------------------|----------------|---------------------------------------|------------|--------------------------------------|---|-----------|---------------|------------------------|-------|-----------|---|
| CE            | 0020               | 0E40           | Movement average 1 enabled            | Common     | MOV.1                                | H'00000000: OFF (0)<br>H'00000001: ON (1) | OFF, ON   | OFF           | -                      | -     | -         |   |
|               | 0021               | 0E42           | Movement average 2 enabled            | Common     | MOV.2                                | H'00000000: OFF (0)<br>H'00000001: ON (1) | OFF, ON   | OFF           | -                      | -     | -         |   |
|               | 0022               | 0E44           | Movement average 3 enabled            | Common     | MOV.3                                | H'00000000: OFF (0)<br>H'00000001: ON (1) | OFF, ON   | OFF           | -                      | -     | -         |   |
|               | 0023               | 0E46           | Movement average 4 enabled            | Common     | MOV.4                                | H'00000000: OFF (0)<br>H'00000001: ON (1) | OFF, ON   | OFF           | -                      | -     | -         |   |
|               | 0024               | 0E48           | Extraction of square root 1 enabled   | Common     | SQR.1                                | H'00000000: OFF (0)<br>H'00000001: ON (1) | OFF, ON   | OFF           | -                      | -     | -         |   |
|               | 0025               | 0E4A           | Extraction of square root 2 enabled   | Common     | SQR.2                                | H'00000000: OFF (0)<br>H'00000001: ON (1) | OFF, ON   | OFF           | -                      | -     | -         |   |
|               | 0026               | 0E4C           | Extraction of square root 3 enabled   | Common     | SQR.3                                | H'00000000: OFF (0)<br>H'00000001: ON (1) | OFF, ON   | OFF           | -                      | -     | -         |   |
|               | 0027               | 0E4E           | Extraction of square root 4 enabled   | Common     | SQR.4                                | H'00000000: OFF (0)<br>H'00000001: ON (1) | OFF, ON   | OFF           | -                      | -     | -         |   |
|               | 002A               | 0E54           | Straight-line approximation 1 enabled | Common     | SL.1                                 | H'00000000: OFF (0)<br>H'00000001: ON (1) | OFF, ON   | OFF           | -                      | -     | -         |   |
|               | 002B               | 0E56           | Straight-line approximation 2 enabled | Common     | SL.2                                 | H'00000000: OFF (0)<br>H'00000001: ON (1) | OFF, ON   | OFF           | -                      | -     | -         |   |
|               | 002E               | 0E5C           | Broken-line approximation 1 enabled   | Common     | FL.1                                 | H'00000000: OFF (0)<br>H'00000001: ON (1) | OFF, ON   | OFF           | -                      | -     | -         |   |
|               | 002F               | 0E5E           | Reserve                               |            |                                      |   |           |               |                        |       |           |   |
|               | -                  | -              | Motor calibration                     | CH         | CLB                                  | OFF (0)<br>ON (0)                         | OFF, ON   | OFF           | -                      | -     | -         | - |
| 0030          | 0E60               | Travel time    | CH                                    | TRT        | H'00000001 to H'0000009E7 (1 to 999) | 1 to 999                                  | 30        | 0             | Seconds                |       |           |   |

|   | Setting (monitor) value  | Default value (transfer output upper-limit / lower-limit) | Decimal point position/units |
|---|--|---|------------------------------|
| SP  | SP setting lower limit to SP setting upper limit   | 1300.0/-200.0   | Depends on input type / EU   |
| Ramp SP                                   | SP setting lower limit to SP setting upper limit   | 1300.0/-200.0   | Depends on input type / EU   |
| Present Value(PV)                         | Lower limit of sensor setting range to upper limit of sensor setting range (temperature) | Upper/lower limit of sensor setting range                 | Depends on input type / EU   |
|   | H'FFFFB1E1 to H'0001869F (-19999 to 9999) (analog)                                       | Scaling display value 2/1                                 | Depends on input type / EU   |
| Control output (Heat side or open side)   | Standard: H'FFFFFFFCE to H'0000041A (-5.0 to 105.0)                                      | 100.0/0.0   | 1/%                          |
|   | Heat/cool: H'00000000 to H'0000041A (0.0 to 105.0)                                       | 100.0/0.0   | 1/%                          |
| Control output (Cool side or closed side) | H'00000000 to H'0000041A (0.0 to 105.0)  | 100.0/0.0   | 1/%                          |
|   | H'FFFFFFF9C to H'0000044C (-10.0 to 110.0)   | 100.0/0.0   | 1/%                          |

The Input type, temperature units, scaling display value, and SP upper/lower limit are initialized when the corresponding control / transfer output is changed.

\*2 Initial settings in each control mode are shown below.

| Control mode                           | Input type | Control transfer output 1 assignment | Control transfer output 2 assignment | Control transfer output 3 assignment | Control transfer output 4 assignment |
|--|------------|--------------------------------------|--------------------------------------|--------------------------------------|--------------------------------------|
| Standard control                       | 1 input    | 1                                    | 0                                    | 0                                    | 0                                    |
|  | 2 inputs   | 1                                    | 9                                    | 0                                    | 0                                    |
|  | 4 inputs   | 1                                    | 9                                    | 17                                   | 25                                   |
| Heating/cooling control                | 1 input    | 1                                    | 2                                    | 0                                    | 0                                    |
|  | 2 inputs   | 1                                    | 2                                    | 9                                    | 10                                   |
|  | 4 inputs   | 1                                    | 2                                    | 9                                    | 10                                   |
| Standard control with remote SP        | 1 input    | -                                    | -                                    | -                                    | -                                    |
|  | 2 inputs   | 1                                    | 0                                    | 0                                    | 0                                    |
|  | 4 inputs   | -                                    | -                                    | -                                    | -                                    |
| Heating/cooling control with remote SP | 1 input    | -                                    | -                                    | -                                    | -                                    |
|  | 2 inputs   | 1                                    | 2                                    | 0                                    | 0                                    |
|  | 4 inputs   | -                                    | -                                    | -                                    | -                                    |
| Ratio control                          | 1 input    | -                                    | -                                    | -                                    | -                                    |
|  | 2 inputs   | 1                                    | 0                                    | 0                                    | 0                                    |
|  | 4 inputs   | -                                    | -                                    | -                                    | -                                    |
| Cascade standard control               | 1 input    | -                                    | -                                    | -                                    | -                                    |
|  | 2 inputs   | 9                                    | 0                                    | 0                                    | 0                                    |
|  | 4 inputs   | -                                    | -                                    | -                                    | -                                    |
| Cascade heating/cooling control        | 1 input    | -                                    | -                                    | -                                    | -                                    |
|  | 2 inputs   | 9                                    | 10                                   | 0                                    | 0                                    |
|  | 4 inputs   | -                                    | -                                    | -                                    | -                                    |
| Position proportional control          | 1 input    | -                                    | -                                    | 0                                    | 0                                    |

Alarm setting level "H-" indicated in set values (monitor values) are values set by communication (monitor).

| Variable type | CompoWay/F Address | Modbus Address                  | Setting data | Attributes | Character   | Setting (monitor) value   | Character          | Default value | Decimal point position | Units                                   | Set value |  |   |     |  |
|---------------|--------------------|---------------------------------|--------------|------------|---|---|--------------------|---------------|------------------------|---|-----------|--|---|-----|--|
| CF            | 0000               | 0F00                            | Alarm 1 type | CH         | R1L1  | H'00000000: No alarm (0)  | 0                  |               |                        |   |           |  |   |     |  |
|               |                    |                                 |              |            | R1L2  | H'00000001: Upper-and lower-limit alarm (1)                       |                    |               |                        |   |           |  |   |     |  |
|               |                    |                                 |              |            | R1L3  | H'00000002: Upper-limit alarm (2)                                 |                    |               |                        |   |           |  |   |     |  |
|               |                    |                                 |              |            | R1L4  | H'00000003: Lower-limit alarm (3)                                 |                    |               |                        |   |           |  |   |     |  |
|               |                    |                                 |              |            | R1L5  | H'00000004: Upper-and lower-limit of range alarm (4)              |                    |               |                        |   |           |  |   |     |  |
|               |                    |                                 |              |            | R1L6  | H'00000005: Upper-and lower-limit alarm with standby sequence (5) |                    |               |                        |   |           |  |   |     |  |
|               |                    |                                 |              |            | R1L7  | H'00000006: Upper-limit alarm with standby sequence (6)           |                    |               |                        |   |           |  |   |     |  |
|               |                    |                                 |              |            | R1L8  | H'00000007: Lower-limit alarm with standby sequence (7)           |                    |               |                        |   |           |  |   |     |  |
|               |                    |                                 |              |            | R1L9  | H'00000008: Absolute-value upper-limit alarm (8)                  |                    |               |                        |   |           |  |   |     |  |
|               |                    |                                 |              |            | R1L10   | H'00000009: Absolute-value lower-limit alarm (9)                  |                    |               |                        |   |           |  |   |     |  |
|               |                    |                                 |              |            | R1L11   | H'0000000A: Absolute-value upper-limit with standby sequence (10) |                    |               |                        |   |           |  |   |     |  |
|               |                    |                                 |              |            | R1L12   | H'0000000B: Absolute-value lower-limit with standby sequence (11) |                    |               |                        |   |           |  |   |     |  |
|               |                    |                                 |              |            | 0001  | 0F02  | Alarm 1 latch      | CH            | R1L13                  | H'00000000: OFF (0)                     | OFF       |  |   |     |  |
|               |                    |                                 |              |            |   |   |                    |               |                        | H'00000001: ON (1)                      |           |  |   |     |  |
|               |                    |                                 |              |            | 0002  | 0F04  | Alarm 1 hysteresis | CH            | R1L14                  | H'00000001 to H'0000270F: 0.01 to 99.99 | 0.02      |  | 2 | %FS |  |
|               |                    |                                 |              |            | 0003  | 0F06  | Alarm 2 type       | CH            | R1L15                  | Same as alarm type 1                    |           |  |   |     |  |
|               |                    |                                 |              |            | 0004  | 0F08  | Alarm 2 latch      | CH            | R1L16                  | H'00000000: OFF (0)                     | OFF       |  |   |     |  |
|               |                    |                                 |              |            |   |   |                    |               |                        | H'00000001: ON (1)                      |           |  |   |     |  |
|               |                    |                                 |              |            | 0005  | 0F0A  | Alarm 2 hysteresis | CH            | R1L17                  | H'00000001 to H'0000270F: 0.01 to 99.99 | 0.02      |  | 2 | %FS |  |
|               |                    |                                 |              |            | 0006  | 0F0C  | Alarm 3 type       | CH            | R1L18                  | Same as alarm type 1                    |           |  |   |     |  |
| 0007          | 0F0E               | Alarm 3 latch                   | CH           | R1L19      | H'00000000: OFF (0)                               | OFF   |                    |               |                        |   |           |  |   |     |  |
|               |                    |                                 |              |            | H'00000001: ON (1)                                |   |                    |               |                        |   |           |  |   |     |  |
| 0008          | 0F10               | Alarm 3 hysteresis              | CH           | R1L20      | H'00000001 to H'0000270F: 0.01 to 99.99           | 0.02  |                    | 2             | %FS                    |   |           |  |   |     |  |
| 0009          | 0F12               | Alarm 4 type                    | CH           | R1L21      | Same as alarm type 1                              |   |                    |               |                        |   |           |  |   |     |  |
| 000A          | 0F14               | Alarm 4 latch                   | CH           | R1L22      | H'00000000: OFF (0)                               | OFF   |                    |               |                        |   |           |  |   |     |  |
|               |                    |                                 |              |            | H'00000001: ON (1)                                |   |                    |               |                        |   |           |  |   |     |  |
| 000B          | 0F16               | Alarm 4 hysteresis              | CH           | R1L23      | H'00000001 to H'0000270F: 0.01 to 99.99           | 0.02  |                    | 2             | %FS                    |   |           |  |   |     |  |
| 000C          | 0F18               | Standby sequence restart        | CH           | R1E5E      | H'00000000: Condition A (0)                       | A   |                    |               |                        |   |           |  |   |     |  |
|               |                    |                                 |              |            | H'00000001: Condition B (1)                       |   |                    |               |                        |   |           |  |   |     |  |
| 000D          | 0F1A               | Auxiliary output 1 non-exciting | Common       | Sb1n       | H'00000000: Excitation close in alarm: N-O (0)    | Excitation dose in alarm  |                    |               |                        |   |           |  |   |     |  |
|               |                    |                                 |              |            | H'00000001: Non-excitation open in alarm: N+C (1) |   |                    |               |                        |   |           |  |   |     |  |
| 000E          | 0F1C               | Auxiliary output 2 non-exciting | Common       | Sb2n       | H'00000000: Excitation close in alarm: N-O (0)    | Excitation dose in alarm  |                    |               |                        |   |           |  |   |     |  |
|               |                    |                                 |              |            | H'00000001: Non-excitation open in alarm: N+C (1) |   |                    |               |                        |   |           |  |   |     |  |
| 000F          | 0F1E               | Auxiliary output 3 non-exciting | Common       | Sb3n       | H'00000000: Excitation close in alarm: N-O (0)    | Excitation dose in alarm  |                    |               |                        |   |           |  |   |     |  |
|               |                    |                                 |              |            | H'00000001: Non-excitation open in alarm: N+C (1) |   |                    |               |                        |   |           |  |   |     |  |
| 0010          | 0F20               | Auxiliary output 4 non-exciting | Common       | Sb4n       | H'00000000: Excitation close in alarm: N-O (0)    | Excitation dose in alarm  |                    |               |                        |   |           |  |   |     |  |
|               |                    |                                 |              |            | H'00000001: Non-excitation open in alarm: N+C (1) |   |                    |               |                        |   |           |  |   |     |  |



Display adjustment level

"H" - indicated in set values (monitor values) are values set by communication (monitor).

| Variable type | CompoWay/F Address | Modbus Address | Setting data                     | Attributes | Character   | Setting (monitor) value  | Character  | Default value          | Decimal point position | Units | Set value |  |
|---------------|--------------------|----------------|----------------------------------|------------|-------------|--|--|------------------------|------------------------|-------|-----------|--|
| DO            | 0000               | 1000           | "PV/SP" display screen selection | Common     | <b>SPdP</b> | H'00000000 to H'00000003: 0 to 3   | <b>0 to 3</b>                                    | 1                      | -                      | -     |           |  |
|               | 0001               | 1002           | MV display selection             | CH         | <b>adSL</b> | H'00000000: MV (Heating) (0)<br>H'00000001: MV (Cooling) (1)   | <b>00 1-0</b>                                    | Heating (0)            | -                      | -     |           |  |
|               | 0002               | 1004           | Bar graph display item           | Common     | <b>BR-t</b> | H'00000000: OFF (0)<br>H'00000001: Deviation: 1EU/Segment (1)<br>H'00000002: 10EU/Segment (2)<br>H'00000003: 20EU/Segment (3)<br>H'00000004: 100EU/Segment (4)<br>H'00000005: MV (Heating) / Valve opening: O (5)<br>H'00000006: MV (Cooling) : C-O (6)  | <b>OFF, 1EU, 10EU, 20EU, 100EU, 0, C-O</b>       | MV / Valve opening (5) | -                      | -     |           |  |
|               | 0003               | 1006           | Display auto-return time         | Common     | <b>RET</b>  | H'00000000 to H'00000063 (0 to 99 (0): Display auto reset disabled)  | <b>0 to 99</b>                                   | 0                      | 0                      | -     | Seconds   |  |
|               | 0004               | 1008           | Display refresh period           | Common     | <b>dREF</b> | H'00000000: OFF (0)<br>H'00000001: 0.5 sec (1)<br>H'00000002: 1 sec (2)<br>H'00000003: 2 sec (3)<br>H'00000004: 4 sec (4)  | <b>OFF, 0.5, 1, 2, 4</b>                         | 0.5                    | -                      | -     | Seconds   |  |
|               | 0005               | 100A           | Monitor item level setting       | Common     | <b>nonL</b> | H'00000000: Disabled: OFF (0)<br>H'00000001: Input initial setting level: L.0 (1)<br>H'00000002: Control initial setting level: L.1 (2)<br>H'00000003: Control initial setting 2 level: L.2 (3)<br>H'00000004: Alarm setting level: L.3 (4)<br>H'00000005: Display adjustment level: L.4 (5)<br>H'00000006: Communication setting level: L.5 (6)<br>H'00000007: Advanced function setting level: L.ADF (7)<br>H'00000008: Expansion control setting level: L.EXC (8) | <b>OFF, L0, L1, L2, L3, L4, L5, L.ADF, L.EXC</b> | OFF                    | -                      | -     |           |  |
|               | 0006               | 100C           | Start display scan at power on   | Common     | <b>SL-n</b> | H'00000000: OFF (0)<br>H'00000001: ON (1)  | <b>OFF, on</b>                                   | OFF                    | -                      | -     | -         |  |
|               | 0007               | 100E           | Display scan period              | Common     | <b>SL-t</b> | H'00000000 to H'00000063 (0 to 99 (0): Display scan disabled)  | <b>0</b>   | 2                      | -                      | -     | Seconds   |  |

Communication setting level

| Variable type | CompoWay/F |                        | Setting data                                   | Attributes   | Character                          | Setting (monitor) value   | Character              | Default value | Decimal point position | Units | Set value |  |
|---------------|------------|------------------------|--|--------------|------------------------------------|---|------------------------|---------------|------------------------|-------|-----------|--|
|               | Address    | Modbus Address         |  |              |                                    |   |                        |               |                        |       |           |  |
| D1            | 0000       | 1100                   | Protocol selection                             | Common       | <b>ᠫᠰᠡᠯ</b>                        | H'00000000:CompoWay/F: CWF (0)<br>H'00000001:Modbus: MOD (1)                        | <b>᠘ᠠᠮᠤᠮᠤᠳ</b>         | CWF           | -                      | -     |           |  |
|               | 0001       | 1102                   |  | Common       | <b>ᠠᠨᠠᠭ</b>                        | H'00000000 to H'00000063 (0 to 99)  | <b>ᠠ to ᠑᠑</b>         | 1             | -                      | -     |           |  |
|               | 0002       | 1104                   | Communication unit No.<br>Communications speed | Common       | <b>ᠪᠫᠰ</b>                         | H'00000000:9.6 (0)<br>H'00000001:19.2 (1)<br>H'00000002:38.4 (2)                    | <b>᠑᠘, 1᠑.2, 38.4</b>  | 9.6           | -                      | kbps  |           |  |
|               | 0003       | 1106                   | Communication data length                      | Common       | <b>᠘ᠡᠨ</b>                         | H'00000000:7 (0)<br>H'00000001:8 (1)  | <b>7, 8</b>            | 7             | -                      | -     | Bit       |  |
|               | 0004       | 1108                   | Communication stop bit                         | Common       | <b>ᠰᠪᠢᠲ</b>                        | H'00000000:1 (0)<br>H'00000001:2 (1)  | <b>1, 2</b>            | 2             | -                      | -     | Bit       |  |
|               | 0005       | 110A                   | Communication parity                           | Common       | <b>ᠫᠷᠢᠲᠢ</b>                       | H'00000000: Noe: NONE (0)<br>H'00000001: Even: EVEN (1)<br>H'00000002: Odd: ODD (2) | <b>ᠨᠠᠨᠢ, ᠡᠠᠭᠢ, ᠠᠳᠳ</b> | EVEN          | -                      | -     | -         |  |
| 0006          | 110C       | Transmission wait time | Common   | <b>ᠰᠠᠳᠠᠳ</b> | H'00000000 to H'00000063 (0 to 99) | <b>ᠠ to ᠑᠑</b>  | 20                     | -             | -                      | ms    |           |  |

\*1 .... Changes in communication parameter settings become effective after reset.

## Advanced function setting level

\*H-'-' indicated in set values (monitor values) are values set by communication (monitor).

| Component/Variable type | F/W Address | Modbus Address | Setting data                 | Attributes | Character | Setting (monitor) value  | Character  | Default value | Decimal point position | Units | Set value |
|-------------------------|-------------|----------------|------------------------------|------------|-----------|--|--|---------------|------------------------|-------|-----------|
| D2                      | -           | -              | Parameter initialization     | Common     | 0.0.0.0   | OFF (0)<br>ON (0)  | OFF, ON  | OFF           | -                      | -     |           |
|                         | 0000        | 1200           | PF1 setting                  | Common     | PF1       | H'00000000: OFF (0)<br>H'00000001: RUN (1)<br>H'00000002: STOP (2)<br>H'00000003: R-S (3)<br>H'00000004: ALLR (4)<br>H'00000005: ALLS (5)<br>H'00000006: AT (6)<br>H'00000007: BANK (7)<br>H'00000008: A-M (8)<br>H'00000009: PFD (9)<br>Same as PF1 setting   | OFF, ON, STOP, R-S, ALLR, ALLS, AT, BANK, A-M, PFD | A-M (8)       | -                      | -     |           |
|                         | 0001        | 1202           | PF2 setting                  | Common     | PF2       | Same as PF1 setting  | Same as above                                      | R-S (3)       | -                      | -     |           |
|                         | 0002        | 1204           | PF1 monitor / setting item 1 | CH         | PF1.1     | H'00000000: Disabled (0)<br>(SF) (1)<br>H'00000001: PV/SP/Bank setting is possible<br>(SF) (2)<br>H'00000002: PV/SP/MV setting is possible<br>(SF) (2)<br>H'00000003: PV/Deviation Monitor only (3)<br>H'00000004: Proportional band (P) setting is possible (4)<br>H'00000005: Integral time (I) setting is possible (5)<br>H'00000006: Differential time (D) setting is possible (6)<br>H'00000007: Alarm 1 setting is possible (7)<br>H'00000008: Alarm upper limit 1 setting is possible (8)<br>H'00000009: Alarm upper limit 1 setting is possible (9)<br>H'0000000A: Alarm 2 setting is possible (10)<br>H'0000000B: Alarm upper limit 2 setting is possible (11)<br>H'0000000C: Alarm upper limit 2 setting is possible (12)<br>H'0000000D: Alarm 3 setting is possible (13)<br>H'0000000E: Alarm upper limit 3 setting is possible (14)<br>H'0000000F: Alarm upper limit 3 setting is possible (15)<br>H'00000010: Alarm 4 setting is possible (16)<br>H'00000011: Alarm upper limit 4 setting is possible (17)<br>H'00000012: Alarm upper limit 4 setting is possible (18)<br>H'00000013: Banks. setting is possible (19) | PF1.1  | 0 to 99       | 0                      | -     |           |
|                         | 0003        | 1206           | PF1 monitor / setting item 2 | CH         | PF1.2     | Same as PF1 monitor / setting 1  | 0 to 99  | 0             | -                      | -     |           |
|                         | 0004        | 1208           | PF1 monitor / setting item 3 | CH         | PF1.3     | Same as PF1 monitor / setting 1  | 0 to 99  | 0             | -                      | -     |           |
|                         | 0005        | 120A           | PF1 monitor / setting item 4 | CH         | PF1.4     | Same as PF1 monitor / setting 1  | 0 to 99  | 0             | -                      | -     |           |
|                         | 0006        | 120C           | PF1 monitor / setting item 5 | CH         | PF1.5     | Same as PF1 monitor / setting 1  | 0 to 99  | 0             | -                      | -     |           |
|                         | 0007        | 120E           | PF2 monitor / setting item 1 | CH         | PF2.1     | Same as PF1 monitor / setting 1  | 0 to 99  | 0             | -                      | -     |           |
|                         | 0008        | 1210           | PF2 monitor / setting item 2 | CH         | PF2.2     | Same as PF1 monitor / setting 1  | 0 to 99  | 0             | -                      | -     |           |
|                         | 0009        | 1212           | PF2 monitor / setting item 3 | CH         | PF2.3     | Same as PF1 monitor / setting 1  | 0 to 99  | 0             | -                      | -     |           |
|                         | 000A        | 1214           | PF2 monitor / setting item 4 | CH         | PF2.4     | Same as PF1 monitor / setting 1  | 0 to 99  | 0             | -                      | -     |           |
|                         | 000B        | 1216           | PF2 monitor / setting item 5 | CH         | PF2.5     | Same as PF1 monitor / setting 1  | 0 to 99  | 0             | -                      | -     |           |
|                         | 000C        | 1218           | Number of enabled channels   | Common     | CH-n      | H'00000001 to H'00000004 (1 to 4)  | 1 to 4   | *1            | -                      | -     |           |
|                         | -           | -              | RAM write mode               | Common     | RAM       | Backup mode: BKUP (0)<br>RAM write mode: RAM (1)<br>-1999 to 9999  | BKUP to RAM  | BKUP (0)      | -                      | -     |           |
|                         | -           | -              | Move to calibration level    | Common     | CH-n      | -1999 to 9999  | - 1999 to 9999                                     | 0             | -                      | -     |           |

\*1 .... The initial setting for the number of enabled channels varies depending on the model, and is the maximum value of the configuration.

Expansion control setting level

"H-" indicated in set values (monitor values) are values set by communication (monitor).

| Variable type | CompoWay/F Address | Modbus Address | Setting data                                  | Attributes | Character | Setting (monitor) value  | Character                        | Default value | Decimal point position  | Units | Set value |
|---------------|--------------------|----------------|---|------------|-----------|--|----------------------------------|---------------|-------------------------|-------|-----------|
| D3            | 0000               | 1300           | Operation at power on                         | CH         | P-ān      | H'00000000: Continue: CONT (0)<br>H'00000001: Stop: STOP (1)<br>H'00000002: Manual mode: MANU (2)            | CONT, Stop, MANU                 | CONT          | -                       | -     | -         |
|               | 0001               | 1302           | SP tracking                                   | CH         | SPēr      | H'00000000: Off: OFF (0)<br>H'00000001: On: ON (1)   | OFF, ān                          | OFF           | -                       | -     | -         |
|               | 0002               | 1304           | PID set automatic selection data              | CH         | Pāāā      | H'00000000: PV (0)<br>H'00000001: DV (1)   | PV, ān                           | PV            | -                       | -     | -         |
|               | 0003               | 1306           | PID set automatic selection hysteresis        | CH         | PāāH      | H'00000000 to H'0000270F (0.10 to 99.99)   | 0.10 to 99.99                    | 0.50          | 2                       | %FS   | -         |
|               | 0004               | 1308           | PV dead band                                  | CH         | P-dā      | H'00000000 to H'0001869F (0 to 99999)  | 0 to 99999                       | 0             | According to input type | EU    | -         |
|               | 0005               | 130A           | Input 1 cold junction compensation            | Common     | āāā.ā     | H'00000000: OFF (0)<br>H'00000001: ON (1)  | OFF, ān                          | ON            | -                       | -     | -         |
|               | 0006               | 130C           | Input 2 cold junction compensating system     | Common     | āāā.ā     | H'00000000: OFF (0)<br>H'00000001: ON (1)  | OFF, ān                          | ON            | -                       | -     | -         |
|               | 0007               | 130E           | Input 3 cold junction compensation            | Common     | āāā.ā     | H'00000000: OFF (0)<br>H'00000001: ON (1)  | OFF, ān                          | ON            | -                       | -     | -         |
|               | 0008               | 1310           | Input 4 cold junction compensation            | Common     | āāā.ā     | H'00000000: OFF (0)<br>H'00000001: ON (1)  | OFF, ān                          | ON            | -                       | -     | -         |
|               | 000A               | 1314           | α   | CH         | āāāā      | H'00000000 to H'00000064 (0.00 to 1.00)  | 0.00 to 1.00                     | 0.65          | 2                       | -     | -         |
|               | 000B               | 1316           | PV tracking                                   | CH         | Pāēr      | H'00000000: Off: OFF (0)<br>H'00000001: On: ON (1)   | OFF, ān                          | OFF           | -                       | -     | -         |
|               | 000C               | 1318           | Manual output method                          | CH         | āāāā      | H'00000000: MV hold: HOLD (0)<br>H'00000001: Default value output: INIT (1)                                  | HOLD, āāāā                       | HOLD          | -                       | -     | -         |
|               | 000D               | 131A           | Manual MV initial value                       | CH         | āāāā      | Standard: H'FFFFFFCE to H'0000041A (-5.0 to 105.0)<br>Heat/cool: H'FFFFFFBE6 to H'0000041A (-105.0 to 105.0) | -5.0 to 105.0<br>-105.0 to 105.0 | 0.0           | 1                       | %     | -         |
|               | 000E               | 131C           | MV change rate limit mode                     | CH         | āāāā      | H'00000000: Mode 0: 0<br>H'00000001: Mode 1: 1   | 0, 1                             | 0             | -                       | -     | -         |
|               | 000F               | 131E           | AT calculated gain                            | CH         | āā-ā      | H'00000001 to H'00000064 (0.1 to 10.0)   | 0.1 to 10.0                      | 1.0           | 1                       | -     | -         |
|               | 0010               | 1320           | AT hysteresis                                 | CH         | āā-H      | H'00000001 to H'00000063 (0.1 to 9.9)  | 0.1 to 9.9                       | 0.2           | 1                       | %FS   | -         |
|               | 0011               | 1322           | Limit cycle MV amplitude                      | CH         | āāāā      | H'00000032 to H'000001F4 (5.0 to 50.0)   | 5.0 to 50.0                      | 20.0          | 1                       | %     | -         |
|               | 0012               | 1324           | Temporary A.T. excitation judgement deviation | CH         | āāāā      | H'00000000 to H'000003E8 (0.0 to 100.0)  | 0.0 to 100.0                     | 10.0          | 1                       | %FS   | -         |
|               | 0013               | 1326           | Bump-less at RUN                              | CH         | rāāā      | H'00000000: Disabled: OFF (0)<br>H'00000001: Enabled: ON (1)   | OFF, ān                          | OFF           | -                       | -     | -         |
|               | 0018               | 1330           | Operation at potentiometer input error        | CH         | Pāāā      | H'00000000: Disabled: OFF (0)<br>H'00000001: Enabled: ON (1)   | OFF, ān                          | OFF           | -                       | -     | -         |
|               | 0019               | 1332           | Disturbance overshoot adjustment function     | CH         | dāāā      | H'00000000: Disabled: OFF (0)<br>H'00000001: Enabled: ON (1)   | OFF, ān                          | OFF           | -                       | -     | -         |

## Initialization due to setting changes

Settings that are initialized when related settings are changed are shown in "Related settings that are initialized".

Meaning of symbols: O: Initialized,—: Not initialized,Δ: Added channels initialized

| Changed setting data   | Common   | Common   | CH   | CH   | CH                        | CH             | CH                          | Common            | CH   | CH  | CH   | CH | CH | CH |
|--|--|--|--|--|---------------------------|----------------|-----------------------------|-------------------|--|---|--|----|----|----|
| Object of linked setting data initialization                       | Input type 1<br>Input type 2<br>Input type 3<br>Input type 4   | Temperature unit 1<br>Temperature unit 2<br>Temperature unit 3<br>Temperature unit 4 | Scaling display value 1<br>Scaling display value 2         | Scaling input value 1<br>Scaling input value 2 | Control mode (*2)         | SP upper-limit | PID set auto selection data | Closed / Floating | Control / Transfer output 1 assignment<br>Control / Transfer output 2 assignment<br>Control / Transfer output 3 assignment<br>Control / Transfer output 4 assignment | Operation at input error<br>Potentiometer | Alarm 1 type<br>Alarm 2 type<br>Alarm 3 type<br>Alarm 4 type | CH | CH | CH |
| Linked parameter not run condition                                 | No assignment  | • No assignment<br>• Analog input  | Temperature input  | Temperature input                              | Position optional control | -              | -                           | -                 | -  | -   | -  | -  | -  | -  |
| Scaling display values 1 to 2                                      | (*15)  | -  | -  | -  | (*14)                     | -              | -                           | -                 | -  | -   | -  | -  | -  | -  |
| Scaling input values 1 to 2  | O (*10)  | -  | -  | -  | Δ                         | -              | -                           | -                 | -  | -   | -  | -  | -  | -  |
| SP upper-limit   | O (Lower-limit of input setting range or scaling display value 1)<br>O (Upper-limit of input setting range or scaling display value 2) | O (Upper-limit of input scaling range)<br>O (Lower-limit of input scaling range)     | O (Scaling display value 2)<br>O (Scaling display value 1) | -  | Δ                         | -              | -                           | -                 | -  | -   | -  | -  | -  | -  |
| SP lower-limit   | O (*3)   | O (*3)   | O (*3)   | -  | Δ (*2)                    | -              | -                           | -                 | -  | -   | -  | -  | -  | -  |
| Automatic selection range upper limit (P/D/V) (PID 1 to 8)         | O (Lower-limit of input setting range or scaling display value 1)<br>O (Upper-limit of input setting range or scaling display value 2) | O (Upper-limit of input scaling range)<br>O (Lower-limit of input scaling range)     | O (Scaling display value 2)<br>O (Scaling display value 1) | -  | O (*11)<br>O (*11)        | -              | -                           | -                 | -  | -   | -  | -  | -  | -  |
| Remote SP upper limit  | -  | -  | -  | -  | O                         | -              | -                           | -                 | -  | -   | -  | -  | -  | -  |
| Remote SP lower limit  | -  | -  | -  | -  | O                         | -              | -                           | -                 | -  | -   | -  | -  | -  | -  |
| Event input assignments 1 to 6                                     | -  | -  | -  | -  | O                         | -              | -                           | -                 | -  | -   | -  | -  | -  | -  |
| Control / Transfer output assignments 1 to 4                       | -  | -  | -  | -  | O                         | -              | -                           | -                 | -  | -   | -  | -  | -  | -  |
| Auxiliary output assignments 1 to 4                                | -  | -  | -  | -  | O                         | -              | -                           | -                 | -  | -   | -  | -  | -  | -  |
| Control / Transfer output: Output selection 1 to 6                 | -  | -  | -  | -  | O                         | -              | -                           | -                 | -  | -   | -  | -  | -  | -  |
| Enabled number of channels   | -  | -  | -  | -  | O                         | -              | -                           | -                 | -  | -   | -  | -  | -  | -  |
| Upper-limit of transfer output 1 to 4                              | O (*1)   | O (*1)   | O (*1)   | -  | O (*1)                    | O (*1)         | -                           | -                 | O (*1)   | -   | -  | -  | -  | -  |
| Lower-limit of transfer output 1 to 4                              | O (*1)   | O (*1)   | O (*1)   | -  | O (*1)                    | O (*1)         | -                           | -                 | O (*1)   | -   | -  | -  | -  | -  |
| SP banks 0 to 7  | O (*4)   | O (*4)   | O (*4)   | -  | Δ                         | O (*5)         | -                           | -                 | -  | -   | -  | -  | -  | -  |
| Alarm values 1 to 4 (Banks 0 to 7)                                 | O (*6)   | O (*6)   | O (*6)   | -  | Δ                         | -              | -                           | -                 | -  | -   | -  | -  | -  | -  |
| Alarm upper-limit 1 to 4 (Banks 0 to 7)                            | -  | -  | -  | -  | -                         | -              | -                           | -                 | -  | -   | -  | -  | -  | -  |
| Alarm lower-limit 1 to 4 (Banks 0 to 7)                            | -  | -  | -  | -  | -                         | -              | -                           | -                 | -  | -   | -  | -  | -  | -  |
| SP ramp rise value   | O  | O  | O  | -  | Δ                         | -              | -                           | -                 | -  | -   | -  | -  | -  | -  |
| SP ramp fall value   | O  | O  | O  | -  | Δ                         | -              | -                           | -                 | -  | -   | -  | -  | -  | -  |
| Dead band  | O  | O  | O  | -  | Δ                         | -              | -                           | -                 | -  | -   | -  | -  | -  | -  |
| Input adjustment values 1 to 2                                     | O  | O  | O  | -  | Δ                         | -              | -                           | -                 | -  | -   | -  | -  | -  | -  |
| PV dead band   | O  | O  | O  | -  | Δ                         | -              | -                           | -                 | -  | -   | -  | -  | -  | -  |
| Input adjustment values 1 to 2                                     | O (*8)   | O (*8)   | O (*8)   | -  | Δ                         | -              | -                           | -                 | -  | -   | -  | -  | -  | -  |
| Decimal point position   | O (*14)  | -  | -  | -  | Δ (*14)                   | -              | -                           | -                 | -  | -   | -  | -  | -  | -  |
| SP mode  | -  | -  | -  | -  | O (*7)                    | -              | -                           | -                 | -  | -   | -  | -  | -  | -  |
| Manipulated variable at stop (standard / heat / cool)              | -  | -  | -  | -  | O                         | -              | -                           | -                 | -  | -   | -  | -  | -  | -  |
| MV at PV error (standard / heat / cool)                            | -  | -  | -  | -  | O                         | -              | -                           | -                 | -  | -   | -  | -  | -  | -  |
| Manual manipulated variable default value (standard / heat / cool) | -  | -  | -  | -  | O                         | -              | -                           | -                 | -  | -   | -  | -  | -  | -  |
| Manual manipulated variable default (standard / heat / cool)       | -  | -  | -  | -  | O                         | -              | -                           | -                 | -  | -   | -  | -  | -  | -  |
| Bar graph display item   | -  | -  | -  | -  | O                         | -              | -                           | -                 | -  | -   | -  | -  | -  | -  |
| MV display selection   | -  | -  | -  | -  | O                         | -              | -                           | -                 | -  | -   | -  | -  | -  | -  |
| MV upper limit (PID 1 to 8)  | -  | -  | -  | -  | O                         | -              | -                           | -                 | -  | -   | -  | -  | -  | -  |
| MV lower limit (PID 1 to 8)  | -  | -  | -  | -  | O (*12)                   | -              | -                           | -                 | -  | -   | -  | -  | -  | -  |
| Run/Stop   | -  | -  | -  | -  | -                         | -              | -                           | -                 | -  | -   | -  | -  | -  | -  |
| Auto/Manual  | -  | -  | -  | -  | -                         | -              | -                           | -                 | -  | -   | -  | -  | -  | -  |
| Integral time  | -  | -  | -  | -  | -                         | -              | -                           | -                 | -  | -   | -  | -  | -  | -  |

- \*1: When the set value of "Control / transfer output assignment" is SP or ramp SP, the set values are initialized to the SP upper and lower limits.
- \*2: When the control mode is changed, initialization takes place of added channels in the same way as the initialization of related parameters of "Input type" ( $\Delta$  on previous page).
- \*3: Based on the PID set selection data, this is (setting upper limit + setting range  $\times 0.1$ ) in the case of PV and (setting range  $\times 1.1$ ) in the case of DV.
- \*4: The default value is normally 0, however, on occasion the default value may also be the value clamped by the SP upper and lower limit.
- \*5: This becomes the clamp value only when clamped by the SP upper and lower limit.
- \*6: The default value is 0.
- \*7: This is remote SP in the case of the secondary loop of cascade control, and local SP in all other cases.
- \*8: Upper/lower limit of sensor setting range and scaling display values 1 and 2 are initialized.
- \*9: If Closed/Floating is Float in position proportional control, or if "Operation at potentiometer input error" is "Continue", this is initialized if the integral time is 0.
- \*10: This is the upper and lower limit of the sensor setting range. For temperature input, this is the range 4 - 20 mA.
- \*11: Initialized only if the control mode is changed to ratio control (Temperature: Initializes to upper and lower limits of sensor setting range. Analog: Initializes to scaling display values 1 and 2).
- \*12: If the applicable channel is used for heating/cooling control, this is -100%, otherwise it is 0%. (Therefore in cascade heating/cooling control, the primary loop is 0% and the secondary loop is -100%.)
- \*13: The corresponding alarm type numbers in all banks are initialized to 0.
- \*14: When the input type or control mode is changed and there are added channels, scaling display values 1 and 2 and "Decimal point position" are not initialized.

# Setting data list

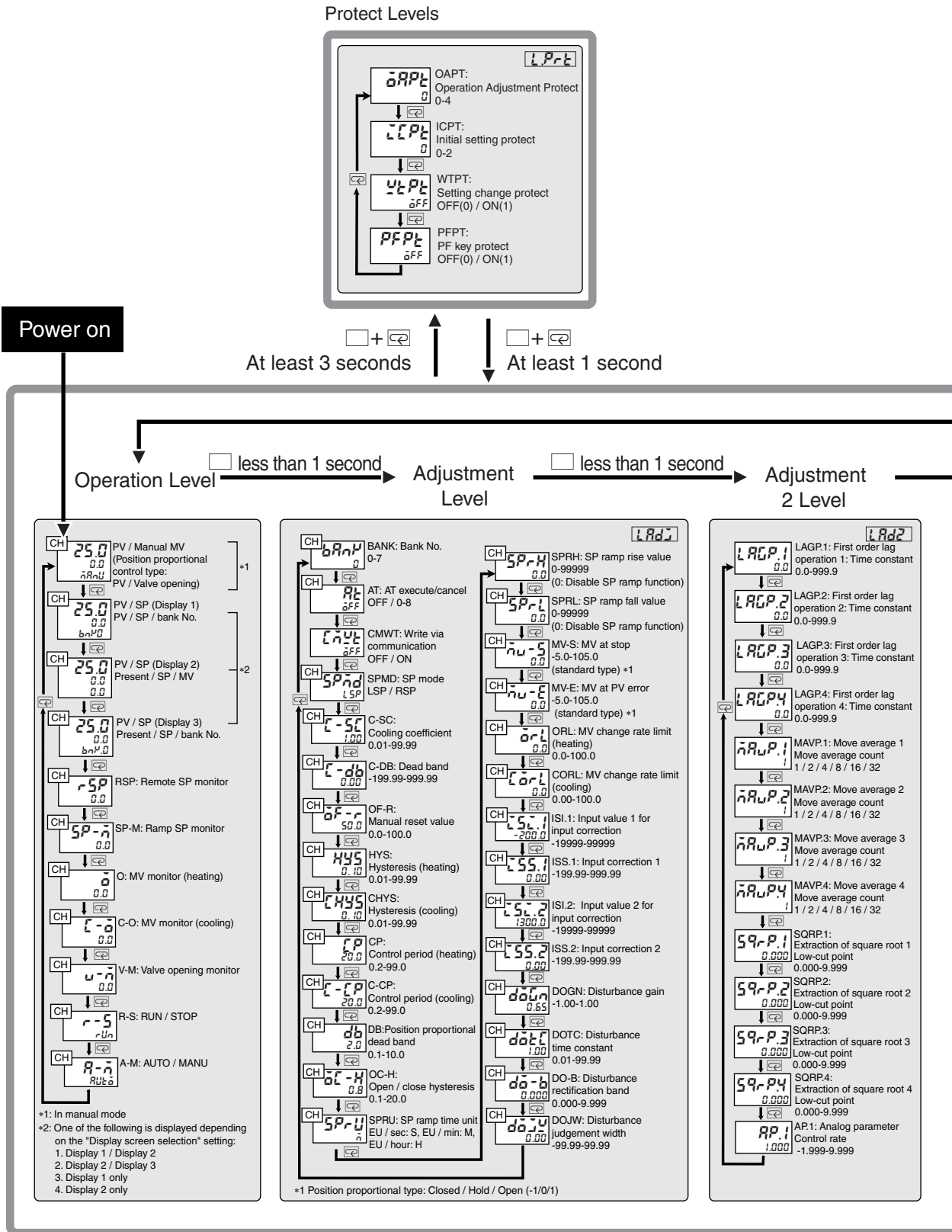

key 3 seconds or more  
**Control stops**

For the input initial setting level, see page A-32

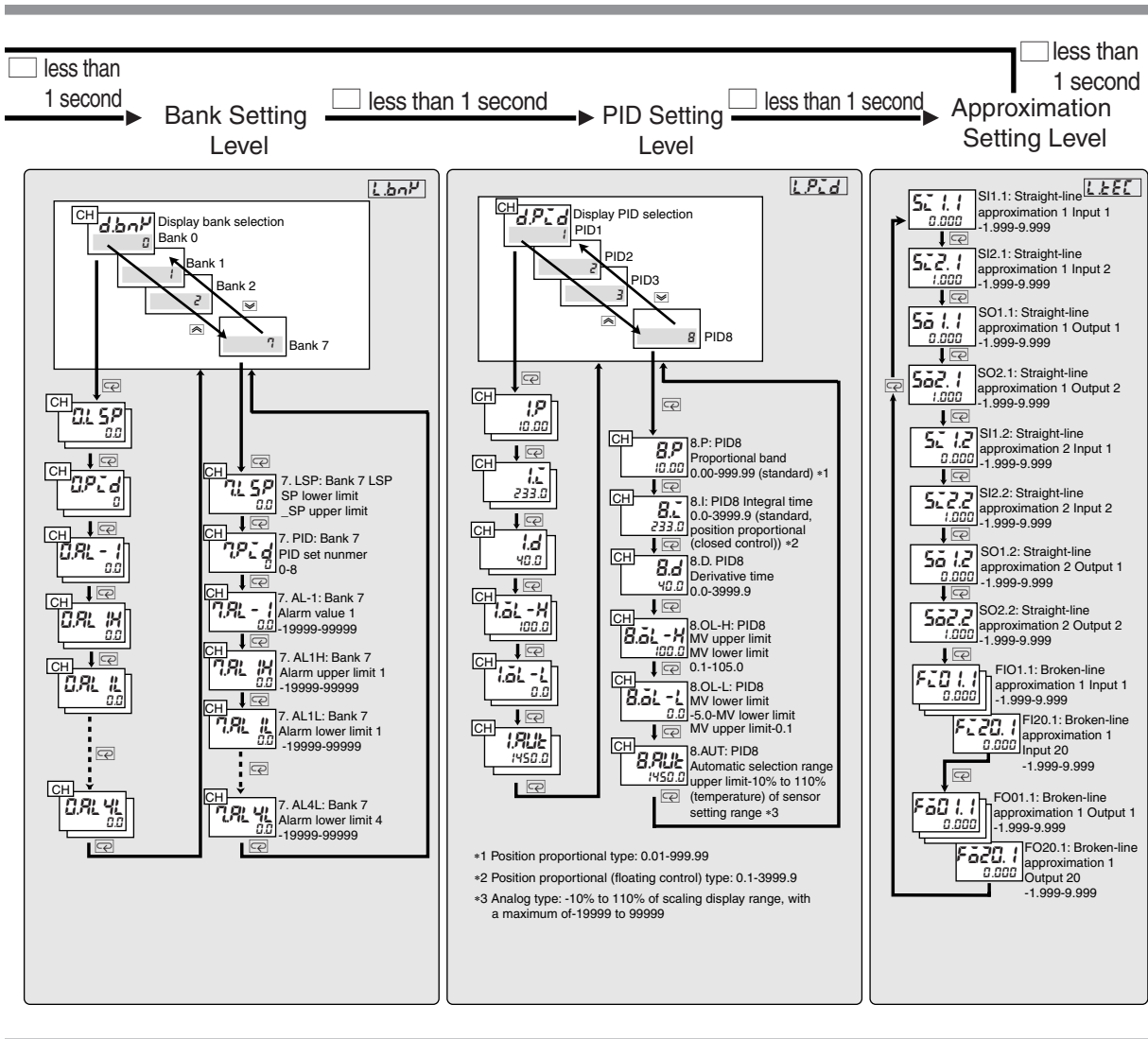
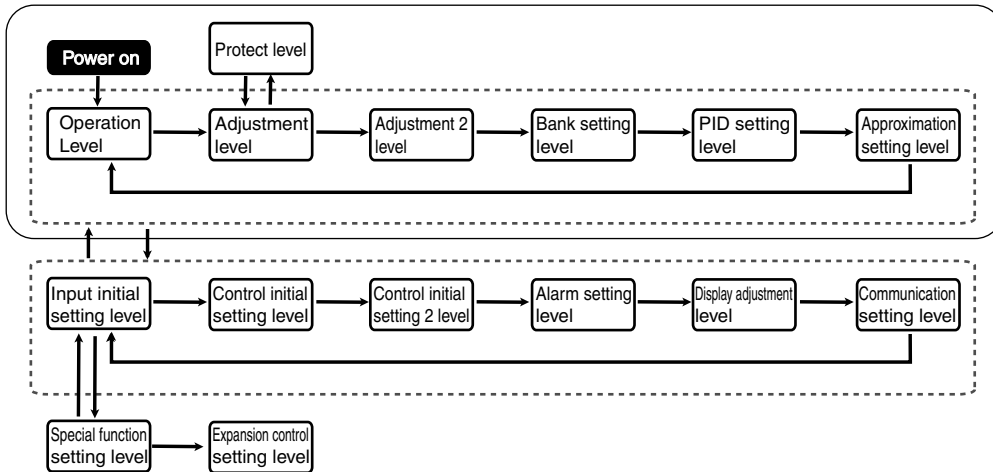

↑  key 1 second or more  
**Control starts**



□ key 3 seconds or more

Control stops

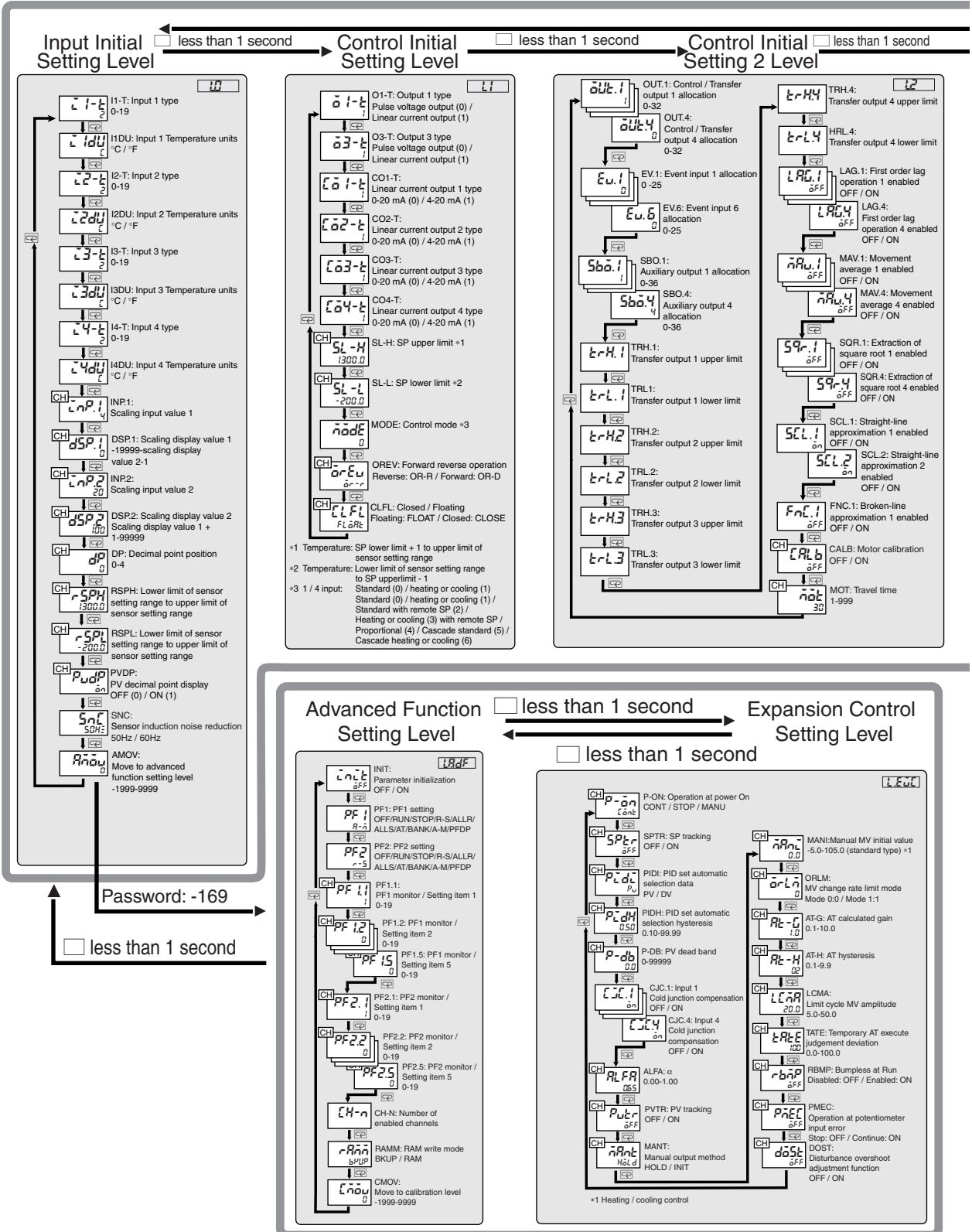

See page A-30 to input initial setting level

key 1 second or more

**Control starts**

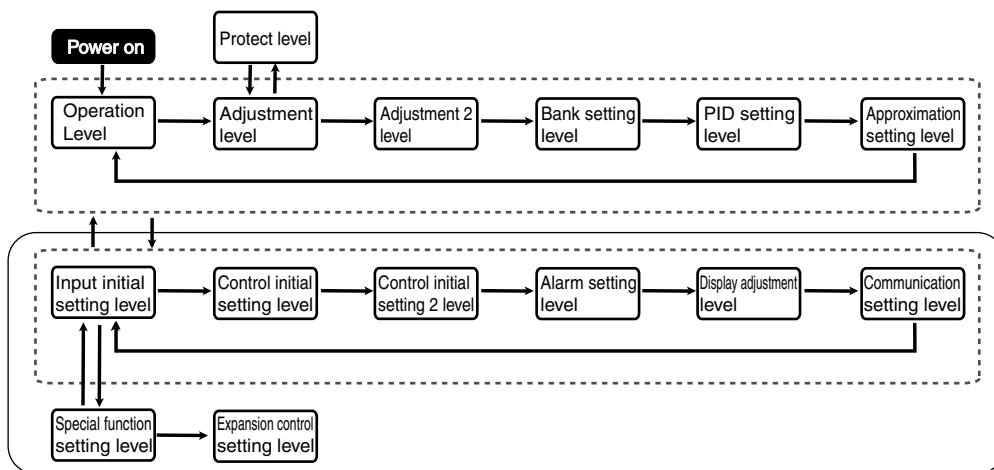
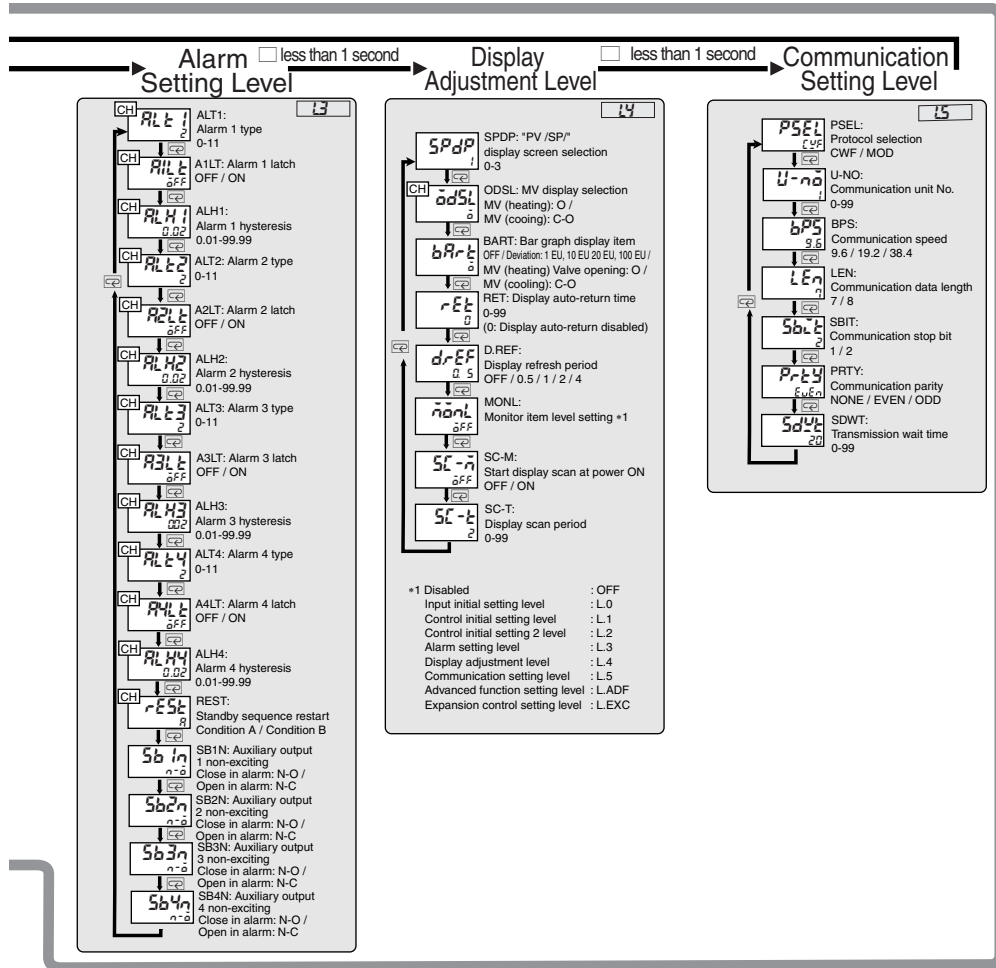



# Index

## Numerics

3-position control ..... 4-18

## A

A/M key ..... 1-6  
Address (Communication/Modbus) ...7-8, A-6  
Addresses  
(Communication/CompoWay/F) ..... 6-7, A-6  
Adjustment 2 level ..... 8-22, A-13  
Adjustment level ..... 8-12, A-12  
Advanced function setting level ..... 8-67, A-26  
Alarm 1 ..... 8-28  
Alarm 2 ..... 8-28  
Alarm 3 ..... 8-28  
Alarm 4 ..... 8-28  
Alarm hysteresis ..... 5-26, 8-56  
Alarm latch ..... 5-27, 8-55  
Alarm lower limit ..... 8-29  
Alarm setting level ..... 8-53, A-23  
Alarm types ..... 4-24, 8-54  
Alarm upper limit ..... 8-29  
Alarm values ..... 4-25  
Alfa ..... 8-76  
Analog input calibration ..... 9-8  
Analog parameter ..... 8-25  
Approximation setting level ..... 8-33, A-16  
ASCII Codes ..... A-5  
AT (Auto-tuning) ..... 4-20, 8-13  
AT calculated gain ..... 8-78  
AT cancel ..... 6-23, 7-23  
AT execute ..... 6-23, 7-23  
AT Execute/Cancel ..... 8-13  
AT hysteresis ..... 8-78  
Auto/Manual ..... 4-30, 5-30, 6-27, 7-27, 8-11  
Automatic selection range upper limi ..... 5-12  
Auxiliary output assignment .. 1-11, 4-23, 8-48  
Auxiliary output non-exciting ..... 5-27, 8-58  
Auxiliary outputs (terminals) ..... 2-13

## B

Bank change ..... 6-22, 7-22  
Bank No. .... 8-13  
Bank No. (Bits 0 to 2) ..... 5-30  
Bank setting level ..... 8-26, A-14  
Banks ..... 1-2, 5-9  
Bar graph display items ..... 8-61  
Broken-line approximation ..... 5-6, 8-34  
Broken-line approximation enable ..... 8-51  
Bumpless run ..... 8-79

## C

Cancel latch ..... 6-28, 7-28  
Cascade control ..... 3-13  
Cascade heating/cooling control ..... 1-9, 4-13  
Cascade open/close ..... 8-14  
Cascade standard control ..... 1-9, 4-13  
CH2 (operation indicator) ..... 1-5  
Changing channels ..... 4-31  
Channel indication ..... 1-5  
Close in alarm/Open in alarm ..... 5-27  
Closed/Floating ..... 3-12, 8-44  
CMW (operation indicator) ..... 1-5  
Cold junction compensation ..... 8-75  
Commands and responses  
(Communication/CompoWay/F) ..... 6-14  
Commands and responses  
(Communication/Modbus) ..... 7-17  
Communication (terminals) ..... 2-17  
Communication data length ..... 8-65  
Communication parity ..... 8-65  
Communication protocol selection ..... 8-64  
Communication setting level ..... 8-63, A-25  
Communication speed ..... 8-64  
Communication stop bit ..... 8-65  
Communication Unit No. .... 8-64  
Communication write OFF/ON ..... 5-29  
CompoWay/F communication protocol ..... 6-2  
Connecting the cold junction compensator 9-5  
Connections ..... 2-4  
Constant at disturbance ..... 5-14  
Control / Transfer output assignment ..... 4-15  
Control initial setting level ..... 8-41, A-18  
Control initial setting level 2 ..... 8-45, A-19  
Control mode ..... 4-13, 8-43  
Control outputs / Transfer outputs  
(terminals) ..... 2-12  
Control period ..... 4-14  
Control period (cooling) ..... 8-16  
Control period (heating) ..... 8-16  
Control/Transfer output allocation .. 1-10, 8-46  
Cooling coefficient ..... 3-8, 8-15

## D

Dead band ..... 3-8, 8-15  
Decimal point position ..... 8-37  
Derivative time ..... 8-31  
Dimensions ..... 2-2  
Direct operation ..... 4-14  
Direct operation (cooling) ..... 1-9  
Display 1 ..... 1-5  
Display 2 ..... 1-5  
Display 3 ..... 1-5, 4-3

|   |            |
|---|------------|
| Display adjustment level .....                  | 8-59, A-24 |
| Display auto-return time .....                  | 8-61       |
| Display PID selection .....                     | 8-30       |
| Display refresh period .....                    | 8-61       |
| Display scan .....                              | 5-19       |
| Display scan period .....                       | 8-62       |
| Disturbance gain .....                          | 5-14, 8-21 |
| Disturbance judgment width .....                | 8-21       |
| Disturbance overshoot adjustment .....          | 5-14       |
| Disturbance overshoot adjustment function ..... | 5-14, 8-80 |
| Disturbance rectification band .....            | 8-21       |
| Disturbance time constant .....                 | 8-21       |
| Down key .....                                  | 1-6        |

## E

|   |            |
|---|------------|
| Echo back test .....                          | 7-29       |
| End codes<br>(Communication/CompoWay/F) ..... | 6-5        |
| Error messages .....                          | 10-3       |
| Event input .....                             | 5-29       |
| Event input allocation .....                  | 5-29, 8-47 |
| Event inputs (terminals) .....                | 2-15       |
| Expansion control setting level .....         | 8-72, A-27 |
| Explanation of the keys .....                 | 1-6        |
| Extraction of square root low-cut point ....  | 8-24       |
| Extraction of square root operations .....    | 5-7        |

## F

|   |      |
|---|------|
| First order lag operation .....             | 5-5  |
| First order lag operation enable .....      | 8-50 |
| First order lag operation time constant ... | 8-22 |
| Forward/reverse operation .....             | 8-44 |
| Frames (Communication/CompoWay/F) ..        | 6-4  |
| Front .....                                 | 1-4  |
| Function codes (Communication/Modbus)       | 7-7  |
| Function key 1 .....                        | 1-6  |
| Function key 2 / channel key .....          | 1-6  |

## H

|   |                |
|---|----------------|
| Heating/cooling control .....                   | 1-9, 3-5, 4-13 |
| Heating/cooling control<br>with remote SP ..... | 1-9, 4-13      |
| Hysteresis .....                                | 4-18           |
| Hysteresis (cooling) .....                      | 8-16           |
| Hysteresis (heating) .....                      | 8-16           |

## I

|   |            |
|---|------------|
| Indicator (control) ranges .....            | A-4        |
| Inferring causes from conditions .....      | 10-4       |
| Initial setting examples .....              | 4-5        |
| Initial setting protect .....               | 5-24       |
| Initialization due to setting changes ..... | A-28       |
| Initialize settings .....                   | 6-27, 7-27 |
| Input error .....                           | 10-3       |

|                                     |            |
|-------------------------------------|------------|
| Input initial setting level .....   | 8-35, A-17 |
| Input shift .....                   | 5-2, 8-20  |
| Input type .....                    | 4-8, 8-36  |
| Input type switch error .....       | 10-3       |
| Input/output configuration .....    | 1-7        |
| Inputs (terminals) .....            | 2-12       |
| Inspecting indicator accuracy ..... | 9-13       |
| Installation procedure .....        | 2-3        |
| Insulation blocks .....             | 2-18       |
| Integral time .....                 | 8-31       |

## K

|                                   |      |
|-----------------------------------|------|
| Key operation (event input) ..... | 5-29 |
|-----------------------------------|------|

## L

|   |           |
|---|-----------|
| Level key .....                                     | 1-6       |
| Limit cycle .....                                   | 4-21      |
| Limit cycle MV amplitude .....                      | 8-78      |
| Limitations during SP ramp .....                    | 5-9       |
| Linear current output output type .....             | 8-42      |
| List of service<br>(communication/CompoWay/F) ..... | 6-6       |
| Local SP .....                                      | 5-9, 8-27 |
| Location of input type switch .....                 | 1-8       |

## M

|  |            |
|--|------------|
| MANU (operation indicator) .....   | 1-5        |
| Manual .....   | 4-29       |
| Manual mode .....  | 4-29       |
| Manual MV .....  | 8-5        |
| Manual MV initial value .....  | 8-77       |
| Manual output method .....   | 8-77       |
| Manual reset value .....   | 8-15       |
| Manual settings .....  | 4-22       |
| Modbus communication protocol .....  | 7-2        |
| Mode key .....   | 1-6        |
| Monitor item level setting .....   | 8-62       |
| Monitor value / setting data compound read<br>(Communication/CompoWay/F) ..... | 6-16       |
| Monitor value / setting data compound read<br>store (write) .....              | 6-19       |
| Monitor value / setting data compound read<br>store check (read) .....         | 6-20       |
| Monitor value / setting data compound store<br>read .....                      | 6-20       |
| Monitor value read<br>(Communication/CompoWay/F) .....                         | 6-14       |
| Monitor value read<br>(Communication/Modbus) .....                             | 7-17       |
| Monitor/Setting item .....   | 5-22       |
| Motor calibration .....  | 3-12, 8-52 |
| Motor calibration error .....  | 10-3       |
| Move average .....   | 5-5, 8-23  |
| Move to advanced function setting level  | 8-40       |
| Move to calibration level .....  | 8-71       |

|                                      |                  |
|--------------------------------------|------------------|
| Move to protect level .....          | 6-26, 7-26       |
| Move to setting area 1 .....         | 6-26, 7-26       |
| Movement average enable .....        | 8-50             |
| MV at error .....                    | 5-18, 8-18       |
| MV at stop .....                     | 4-27, 5-18, 8-18 |
| MV change rate limit .....           | 5-17             |
| MV change rate limit (cooling) ..... | 8-19             |
| MV change rate limit (heating) ..... | 8-19             |
| MV change rate limit mode .....      | 8-78             |
| MV display selection .....           | 8-60             |
| MV limit .....                       | 5-16, 8-31       |
| MV monitor (cooling) .....           | 8-10             |
| MV monitor (heating) .....           | 8-9              |

## N

|                                  |      |
|----------------------------------|------|
| Non-volatile memory error .....  | 10-3 |
| Number of enabled channels ..... | 8-70 |

## O

|  |            |
|--|------------|
| Obtaining input shift values .....                     | 5-3        |
| ON/OFF Control .....                                   | 4-18       |
| Open/Close hysteresis .....                            | 3-12, 8-17 |
| Operation adjustment protect .....                     | 5-24       |
| Operation at potentiometer error .....                 | 8-79       |
| Operation at potentiometer input error ....            | 3-12       |
| Operation at power ON .....                            | 4-27, 8-73 |
| Operation at startup (SP ramp) .....                   | 5-8        |
| Operation commands<br>(Communication/CompoWay/F) ..... | 6-11       |
| Operation commands<br>(Communication/Modbus) .....     | 7-14       |
| Operation indicators .....                             | 1-5        |
| Operation level .....                                  | 8-5, A-11  |
| Operational considerations .....                       | 4-32       |
| OUT1 (operation indicator) .....                       | 1-5        |
| OUT2 (operation indicator) .....                       | 1-5        |
| OUT3 (operation indicator) .....                       | 1-5        |
| OUT4 (operation indicator) .....                       | 1-5        |
| Output calibration .....                               | 9-12       |
| Output state at error .....                            | 10-3       |
| Output type .....                                      | 4-15       |
| Overlap band .....                                     | 3-8, 8-15  |

## P

|                                      |      |
|--------------------------------------|------|
| Panel cutout dimensions .....        | 2-2  |
| Part Names and Functions .....       | 1-4  |
| PF key protect .....                 | 5-25 |
| PF settings .....                    | 5-21 |
| PF1 monitor/setting item .....       | 8-69 |
| PF1 setting .....                    | 8-68 |
| PF2 monitor/setting item .....       | 8-69 |
| PF2 setting .....                    | 8-68 |
| PID set auto select data .....       | 8-74 |
| PID set auto select hysteresis ..... | 8-74 |
| PID set automatic selection .....    | 5-13 |

|  |            |
|--|------------|
| PID set automatic selection data .....                     | 8-74       |
| PID set automatic selection hysteresis ...                 | 8-74       |
| PID Set No. ....   | 5-10, 8-27 |
| PID Set No. Automatic selection range upper<br>limit ..... | 8-32       |
| PID sets .....   | 1-2, 5-12  |
| PID setting level .....                                    | 8-30, A-15 |
| Position proportional control .....                        | 3-9        |
| Position proportional dead band ....                       | 3-12, 8-17 |
| Potentiometer input error .....                            | 10-3       |
| Potentiometer inputs (terminals) .....                     | 2-14       |
| Power supply (terminals) .....                             | 2-11       |
| Precautions when wiring .....                              | 2-11       |
| Proportional band .....                                    | 8-31       |
| Protect .....  | 5-24       |
| Protect key .....  | 1-6        |
| Protect level .....  | 8-3, A-10  |
| Pulling the unit out .....                                 | 2-3        |
| PV dead band .....   | 3-12, 8-74 |
| PV decimal point display .....                             | 8-39       |
| PV tracking .....  | 8-76       |
| PV/SP .....  | 8-7        |
| "PV/SP" display screen selection .....                     | 8-60       |

## R

|  |                  |
|--|------------------|
| RAM data store .....                                       | 6-25, 7-25       |
| RAM write mode .....                                       | 8-70             |
| Ramp SP monitor .....                                      | 8-9              |
| Ratio control .....  | 1-9, 3-18        |
| Read setting data<br>(Communication/Modbus) .....          | 7-18             |
| Registering calibration data .....                         | 9-4              |
| Remote SP lower limit .....                                | 8-38             |
| Remote SP monitor .....                                    | 8-8              |
| Remote SP upper limit .....                                | 8-38             |
| Remote SP/local SP .....                                   | 8-14             |
| Resistance temperature input sensor calibra-<br>tion ..... | 9-10             |
| Reverse operation .....                                    | 4-14             |
| Reverse operation (heating) .....                          | 1-9              |
| RS-485 .....   | 2-17             |
| RSP (operation indicator) .....                            | 1-5              |
| RSP input error .....                                      | 10-3             |
| Run .....  | 6-21, 7-21       |
| Run/Stop .....   | 4-27, 5-30, 8-11 |

## S

|  |      |
|--|------|
| Saving setting .....                   | 4-4  |
| Scaling .....                          | 4-9  |
| Scaling display value .....            | 8-37 |
| Scaling input value .....              | 8-37 |
| Sensor induction noise reduction ..... | 8-40 |
| Set values .....                       | 4-4  |
| Setting and changing the SP .....      | 4-17 |
| Setting areas .....                    | 6-13 |
| Setting change protect .....           | 5-25 |

|   |                        |
|---|------------------------|
| Setting communication parameters .....                          | 5-34                   |
| Setting data compound write<br>(Communication/CompoWay/F) ..... | 6-18                   |
| Setting data read<br>(Communication/CompoWay/F) .....           | 6-15                   |
| Setting data write<br>(Communication/CompoWay/F) .....          | 6-17                   |
| Setting initialization .....                                    | 8-68                   |
| Setting levels .....  | 4-2                    |
| Setting list .....  | A-6                    |
| Software reset .....  | 6-25, 7-25             |
| SP limits .....   | 5-12, 8-43             |
| SP mode .....   | 5-31, 6-28, 7-28, 8-14 |
| SP ramp .....   | 5-8                    |
| SP ramp fall value .....  | 8-18                   |
| SP ramp rise value .....  | 8-18                   |
| SP ramp time units .....  | 8-18                   |
| SP tracking .....   | 8-73                   |
| Specifications .....  | A-2                    |
| Square root extraction enable .....                             | 8-51                   |
| Standard control .....  | 1-9, 3-2, 4-13         |
| Standard control with remote SP .....                           | 1-9, 4-13              |
| Standby sequence .....  | 5-26                   |
| Standby sequence restart .....                                  | 8-57                   |
| Start display scan after power ON .....                         | 8-62                   |
| Status read<br>(Communication/CompoWay/F) .....                 | 6-30                   |
| Status(Communication/CompoWay/F) .....                          | A-8                    |
| Stop .....  | 6-21, 7-21             |
| STOP (operation indicator) .....                                | 1-5                    |
| Straight-line approximation .....                               | 3-20, 8-33             |
| Straight-line approximation enable .....                        | 8-51                   |
| SUB1 (operation indicator) .....                                | 1-5                    |
| SUB2 (operation indicator) .....                                | 1-5                    |
| SUB3 (operation indicator) .....                                | 1-5                    |
| SUB4 (operation indicator) .....                                | 1-5                    |

## T

|   |            |
|---|------------|
| Temperature units .....                               | 4-12, 8-37 |
| Temporary A.T. execution<br>judgement deviation ..... | 4-21, 8-78 |
| Thermocouple calibration .....                        | 9-5        |
| Transfer output lower limit .....                     | 8-49       |
| Transfer output upper limit .....                     | 8-49       |
| Transfer protocol<br>(Communication/CompoWay/F) ..... | 6-2        |
| Transfer protocol<br>(Communication/Modbus) .....     | 7-2        |
| Transmission wait time .....                          | 8-66       |
| Travel time .....                                     | 3-12, 8-52 |
| Troubleshooting .....                                 | 10-1       |
| Typical Control Examples .....                        | 3-1        |

## U

|                                       |     |
|---------------------------------------|-----|
| Unit performance specifications ..... | A-3 |
| Unit ratings .....                    | A-2 |

|   |          |
|---|----------|
| Up key .....                                  | 1-6      |
| User calibration .....                        | 9-1, 9-4 |
| User calibration completion information ..... | 9-3      |
| Using auxiliary output .....                  | 4-23     |
| Using transfer output .....                   | 5-32     |

## V

|                             |      |
|-----------------------------|------|
| Valve opening monitor ..... | 8-10 |
| Variable areas .....        | 6-7  |

## W

|  |                        |
|--|------------------------|
| Write mode .....                                   | 6-24, 7-24             |
| Write setting data<br>(Communication/Modbus) ..... | 7-19                   |
| Write via communication<br>.....                   | 5-35, 6-21, 7-21, 8-14 |